

Solid State Contactors for Heaters

G3PE-545B-2N DC12-24

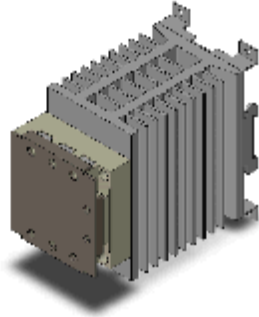

Image

Heater control, Input: 12 to 24 VDC, Output: 200 to 480 VAC, Load current: 45 A, Zero cross function, Screw terminal, DIN track mounting, Number of elements: 2

Product classification	For 3-phase Heater
Zero cross function	Equipped
Operating indicator	Equipped (Yellow)
Rated voltage	12 to 24 VDC
Rated load voltage	200 to 480 VAC
Load current	45 A (at 40 °C)
Terminal structure	Screw terminal

Ratings / Performance

As of April 14, 2021

Ratings

Product classification		For 3-phase Heater
Number of phases		Three phase
Number of elements		2
Isolation method		Phototriac
Zero cross function		Equipped
Operating indicator		Equipped (Yellow)
Terminal structure		Screw terminal
Mounting		DIN track mounting
Input	Rated voltage	12 to 24 VDC
	Operating voltage range	9.6 to 30 VDC
	Input current	10 mA max. (at 24 VDC)
	Operate voltage	9.6 VDC max.
	Release voltage	1 VDC min.
Output	Rated load voltage	200 to 480 VAC
	Load voltage range	180 to 528 VAC
	Minimum load current	0.5 A
	Load current	45 A (at 40 °C)
	Inrush current resistivity	440 A (60 Hz 1 cycle)
	Permissible I2**t	1260 A ² s
	Applicable load	Load carrying capacity

Performance

Operate time	1/2 cycle of load power source + 1 ms max.
Release time	1/2 cycle of load power source + 1 ms max.

Output ON voltage drop	1.8 V max. (RMS)
Leakage current	20 mA max. (at 480 VAC (The leakage current of phase S will be approximately $\sqrt{3}$ times larger))
Insulation resistance	100 M Ω min. (at 500 VDC)
Dielectric strength	2500 VAC 50/60 Hz 1 min
Vibration resistance	10 to 55 to 10 Hz, 0.175 mm single amplitude (0.35 mm double amplitude)
Shock resistance	294 m/s ² (98 m/s ² with reverse mounting)
Ambient temperature (Operating)	-30 to 80 °C (with no freezing or condensation)
Ambient temperature (Storage)	-30 to 100 °C (with no freezing or condensation)
Ambient humidity (Operating)	45 to 85% RH
Weight	Approx. 1650 g

As of April 14, 2021

Outline drawing

As of April 14, 2021

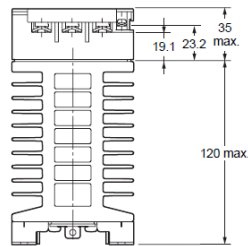
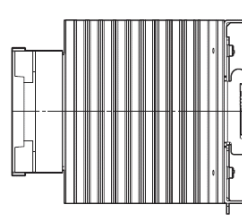
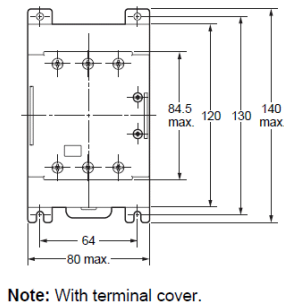
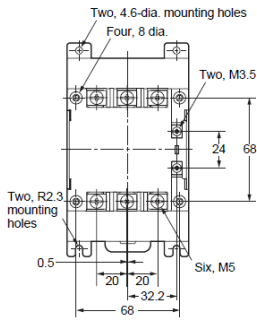

Mounting holes

Mounting Holes

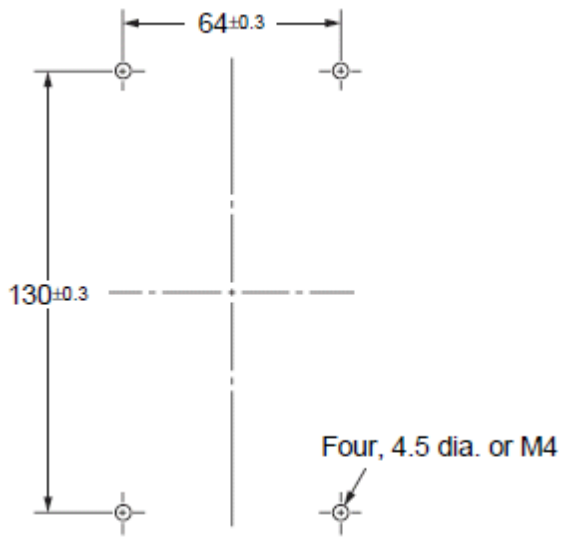

As of April 14, 2021

Connection diagram

As of April 14, 2021

Terminal arrangement and internal connection

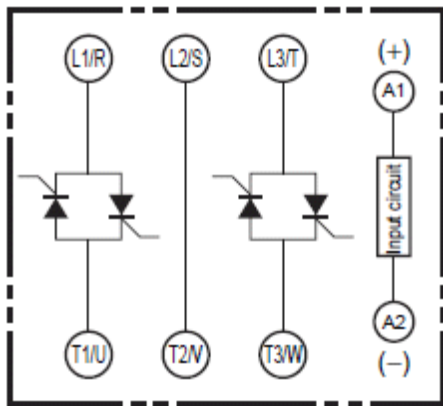

As of April 14, 2021

Characteristic chart

As of April 14, 2021

Input Voltage vs. Input Impedance and Input Voltage vs. Input Current

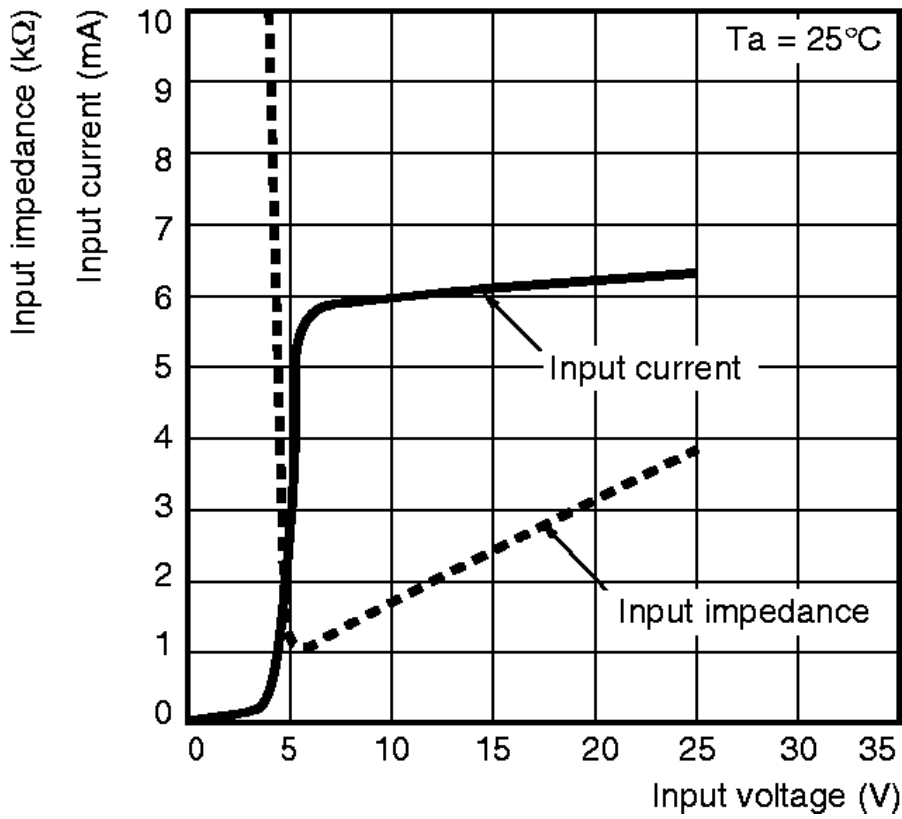

Load current-ambient temperature

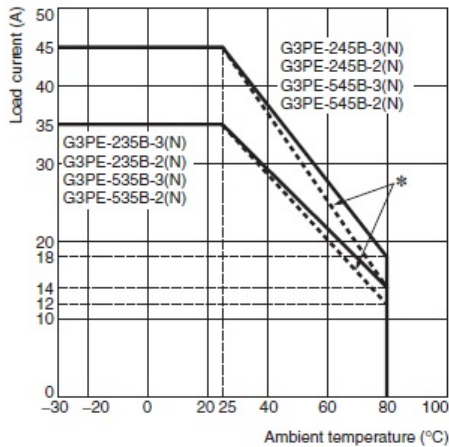

* The dotted lines in the charts are the UL derating curves for the G3PE-235B-3(N), G3PE-245B-3(N), G3PE-235B-2(N), G3PE-245B-2(N), G3PE-535B-3(N), G3PE-545B-3(N), G3PE-535B-2(N), G3PE-545B-2(N).

Inrush current resistivity (Non-repetitive)

Keep the inrush current to below the inrush current resistance value (i.e., below the broken line) if it occurs repetitively.

G3PE-235B-3(N)(H), G3PE-535B-3(N)(H)
G3PE-235B-2(N)(H), G3PE-535B-2(N)(H)
G3PE-245B-3(N)(H), G3PE-545B-3(N)(H)
G3PE-245B-2(N)(H), G3PE-545B-2(N)(H)

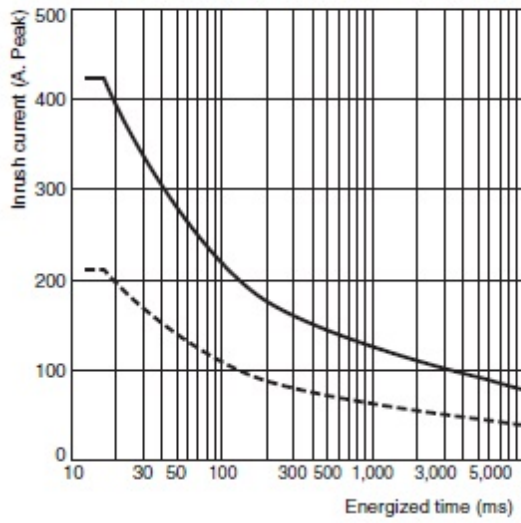

As of April 14, 2021