

# Product data sheet

Specifications



miniature plug in relay, Harmony Electromechanical Relays, 10A, 2CO, without LED, with lockable test button, 120V AC

RXM2CB1F7

! Discontinued

! Discontinued on: May 18, 2022

! End-of-service on: Dec 31, 2022

## Main

Range of product	Harmony Relay
Series name	Miniature
Product or component type	Plug-in relay
Device short name	RXM
Utilisation coefficient	20 %
Sale per indivisible quantity	10

## Complementary

Contact operation	Standard
[Uc] control circuit voltage	120 V AC 50/60 Hz
[Ithe] conventional enclosed thermal current	10 A at -40...55 °C
status LED	Without
[Ui] rated insulation voltage	250 V conforming to IEC 300 V conforming to UL
[Uimp] rated impulse withstand voltage	3.6 kV during 1.2/50 µs conforming to IEC 61810-7
Contacts material	Silver alloy (Ag/Ni)
[Ie] rated operational current	10 A (AC-1/DC-1) conforming to UL 10 A (AC-1/DC-1) NO conforming to IEC 5 A (AC-1/DC-1) NC conforming to IEC
minimum switching current	10 mA
Maximum switching voltage	250 V AC 125 V DC
Minimum switching voltage	17 V
Load current	10 A at 250 V AC 10 A at 30 V DC
Maximum switching capacity	2500 VA AC 300 W DC
Minimum switching capacity	170 mW
Operating rate	<= 1200 cycles/hour under load <= 18000 cycles/hour no-load
Mechanical durability	10000000 cycles
Electrical durability	100000 cycles for resistive load

<b>Average coil consumption in VA</b>	1.55 AC
<b>Drop-out voltage threshold</b>	>= 0.15 U <sub>c</sub> AC
<b>Operating time</b>	20 ms
<b>Average resistance</b>	4500 Ohm network: AC at 20 °C +/- 15 %
<b>Rated operational voltage limits</b>	96...132 V AC
<b>Protection category</b>	RT I
<b>Test levels</b>	Level A group mounting
<b>Operating position</b>	Any position
<b>CAD overall width</b>	21 mm
<b>CAD overall height</b>	27 mm
<b>CAD overall depth</b>	55 mm
<b>Net weight</b>	0.035 kg
<b>Dielectric strength</b>	1800 V AC between coil and contact 1550 V AC between poles 1000 V AC between contacts
<b>Safety reliability data</b>	B10d = 100000

## Environment

<b>Product certifications</b>	GOST UL
<b>Standards</b>	IEC 61810-1 UL 508
<b>Ambient air temperature for storage</b>	-40...70 °C
<b>Ambient air temperature for operation</b>	-40...55 °C
<b>Vibration resistance</b>	3 gn, amplitude = +/- 1 mm (f = 10...55 Hz) without clip conforming to IEC 60068-2-6 5 gn, amplitude = +/- 1 mm (f = 10...55 Hz) with clip conforming to IEC 60068-2-6
<b>IP degree of protection</b>	IP40 conforming to IEC 60529
<b>Shock resistance</b>	10 gn (duration = 11 ms) for opening conforming to IEC 60068-2-27 10 gn (duration = 11 ms) for closing conforming to IEC 60068-2-27

## Packing Units

<b>Unit Type of Package 1</b>	PCE
<b>Number of Units in Package 1</b>	1

## Contractual warranty

<b>Warranty (in months)</b>	18
-----------------------------	----



## Environmental Data

Schneider Electric aims to achieve Net Zero status by 2050 through supply chain partnerships, lower impact materials, and circularity via our ongoing “Use Better, Use Longer, Use Again” campaign to extend product lifetimes and recyclability.

[Environmental Data explained >](#)

[How we assess product sustainability >](#)

### Use Longer



#### Lifetime extension

Repair

No

### Use Again



#### Repack and remanufacture

WEEE Label



The product must be disposed on European Union markets following specific waste collection and never end up in rubbish bins

Dimensions Drawings

Dimensions

---

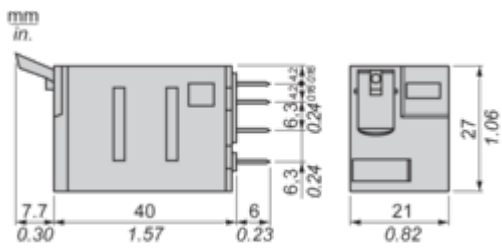

Pin Side View

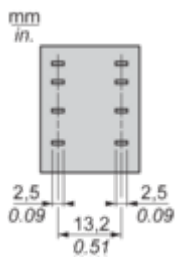

Connections and Schema

Wiring Diagram

---

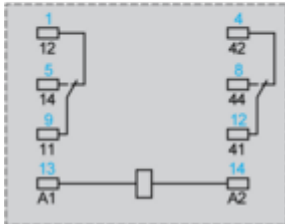
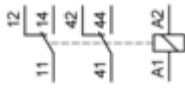

Symbols shown in blue correspond to Nema marking.

Performance Curves

Electrical Durability of Contacts

---

Resistive load

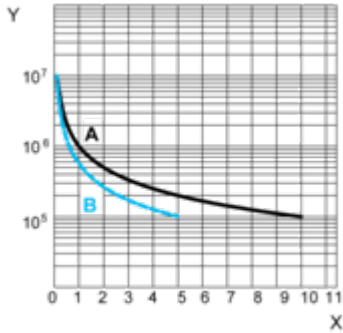

X : Contact current (A)  
 Y : Durability (Number of operating cycles)  
 A : RXM 2CB...  
 B : RXM 4CB...  
 Inductive load

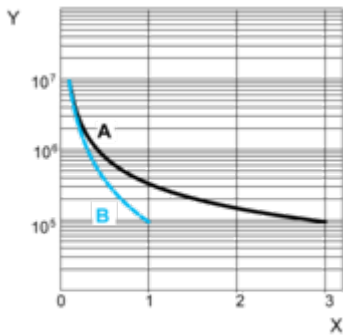

X : Contact current (A)  
 Y : Durability (Number of operating cycles)  
 A : RXM 2CB...  
 B : RXM 4CB...  
**Note** : These are typical curves, actual durability depends on load, environment, duty cycle, etc.

**Maximum Switching Capacity on Resistive and Inductive Loads**

---

RXM 2CB...

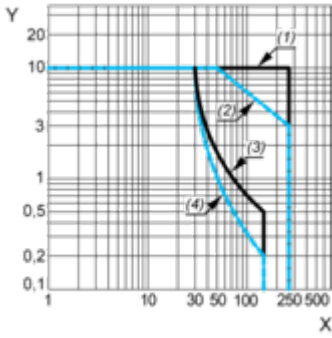

X : Switching Voltage (V)

Y : Switching current (A)

(1) AC resistive load

(2) AC inductive load (cos phi) = 0.4

(3) DC resistive load

(4) DC inductive load (T0.95 = 6 P)

**Note :** These are typical curves, actual durability depends on load, environment, duty cycle, etc.

Technical Illustration

Dimensions

---

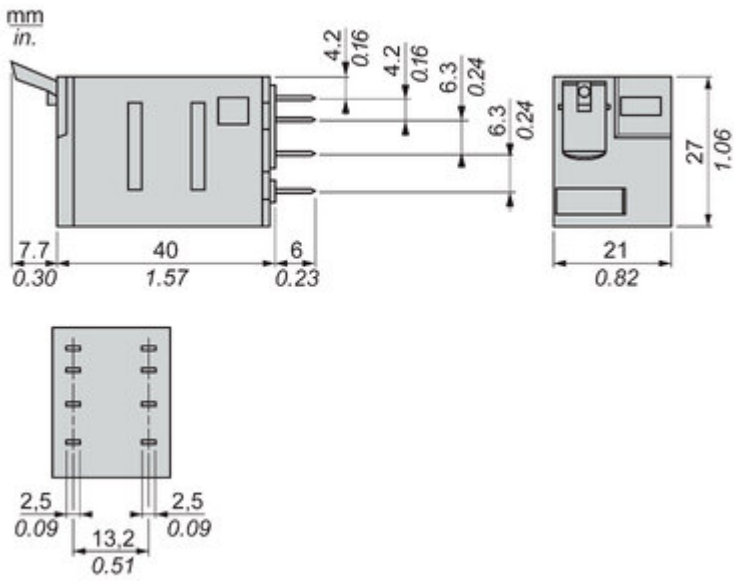

Image of product / Alternate images

Alternative

---



