



Contactor AC 42 V 50/60 HZ AC3 15 kW 400 V AUX contacts 1 NO +1 NC 3-pole, size S0 screw terminal

product brand name	SIRIUS
product designation	Power contactor
product type designation	3RT6
General technical data	
size of contactor	S0
product extension auxiliary switch	Yes
power loss [W] for rated value of the current	
• at AC in hot operating state per pole	2.7 W
• without load current share typical	2.62 W
type of calculation of power loss current-dependent	quadratic
insulation voltage rated value	690 V
degree of pollution	3
surge voltage resistance rated value	6 kV
maximum permissible voltage for protective separation between coil and main contacts according to EN 60947-1	400 V
shock resistance at rectangular impulse	
• at AC	8,3 g / 5 ms, 5,3 g / 10 ms
shock resistance with sine pulse	
• at AC	13,5 g / 5 ms, 8,3 g / 10 ms
mechanical service life (operating cycles)	
• of contactor typical	10 000 000
• of the contactor with added auxiliary switch block typical	10 000 000
Substance Prohibition (day/month/year)	05/01/2012
Net Weight	0.29 kg
Ambient conditions	
installation altitude at height above sea level maximum	2 000 m
ambient temperature	
• during operation	-25 ... +60 °C
• during storage	-55 ... +80 °C
Main circuit	
number of poles for main current circuit	3
number of NO contacts for main contacts	3
number of NC contacts for main contacts	0
operating voltage	
• at AC-3 rated value maximum	690 V
• at AC-3e rated value maximum	690 V
operational current	
• at AC-1 up to 690 V	
— at ambient temperature 40 °C rated value	50 A

<ul style="list-style-type: none"> — at ambient temperature 60 °C rated value 	42 A
<ul style="list-style-type: none"> ● at AC-3 <ul style="list-style-type: none"> — at 400 V rated value — at 690 V rated value 	32 A 21 A
<ul style="list-style-type: none"> ● at AC-3e <ul style="list-style-type: none"> — at 400 V rated value — at 690 V rated value 	32 A 21 A
connectable conductor cross-section in main circuit at AC-1	
<ul style="list-style-type: none"> ● at 60 °C minimum permissible ● at 40 °C minimum permissible 	10 mm ² 10 mm ²
operational current for approx. 200000 operating cycles at AC-4	
<ul style="list-style-type: none"> ● at 400 V rated value ● at 690 V rated value 	12 A 12 A
operating power	
<ul style="list-style-type: none"> ● at AC-1 <ul style="list-style-type: none"> — at 230 V rated value — at 230 V at 60 °C rated value — at 400 V at 60 °C rated value — at 690 V at 60 °C rated value ● at AC-3 <ul style="list-style-type: none"> — at 230 V rated value — at 400 V rated value — at 690 V rated value ● at AC-3e <ul style="list-style-type: none"> — at 230 V rated value — at 400 V rated value — at 690 V rated value 	16 kW 15.5 kW 27.5 kW 47.5 kW 7.5 kW 15 kW 18.5 kW 7.5 kW 15 kW 18.5 kW
operating power for approx. 200000 operating cycles at AC-4	
<ul style="list-style-type: none"> ● at 400 V rated value ● at 690 V rated value 	6 kW 10.3 kW
no-load switching frequency	
<ul style="list-style-type: none"> ● at AC 	5 000 1/h
operating frequency	
<ul style="list-style-type: none"> ● at AC-1 maximum ● at AC-3 maximum ● at AC-3e maximum ● at AC-4 maximum 	1 000 1/h 750 1/h 750 1/h 250 1/h
Control circuit/ Control	
type of voltage of the control supply voltage	AC
control supply voltage at AC	
<ul style="list-style-type: none"> ● at 50 Hz rated value ● at 60 Hz rated value 	42 V 42 V
operating range factor control supply voltage rated value of magnet coil at AC	
<ul style="list-style-type: none"> ● at 50 Hz ● at 60 Hz 	0.8 ... 1.1 0.85 ... 1.1
apparent pick-up power of magnet coil at AC	
<ul style="list-style-type: none"> ● at 50 Hz ● at 60 Hz 	81 VA 79 VA
inductive power factor with closing power of the coil	
<ul style="list-style-type: none"> ● at 50 Hz ● at 60 Hz 	0.72 0.74
apparent holding power of magnet coil at AC	
<ul style="list-style-type: none"> ● at 50 Hz ● at 60 Hz 	10.5 VA 8.5 VA
inductive power factor with the holding power of the coil	
<ul style="list-style-type: none"> ● at 50 Hz 	0.25

<ul style="list-style-type: none"> at 60 Hz 	0.28
Auxiliary circuit	
number of NC contacts for auxiliary contacts instantaneous contact	1
number of NO contacts for auxiliary contacts instantaneous contact	1
operational current at AC-12 maximum	10 A
operational current at AC-15	
<ul style="list-style-type: none"> at 230 V rated value 	10 A
<ul style="list-style-type: none"> at 400 V rated value 	3 A
<ul style="list-style-type: none"> at 690 V rated value 	1 A
operational current at DC-12	
<ul style="list-style-type: none"> at 24 V rated value 	6 A
<ul style="list-style-type: none"> at 110 V rated value 	3 A
<ul style="list-style-type: none"> at 220 V rated value 	1 A
operational current at DC-13	
<ul style="list-style-type: none"> at 24 V rated value 	6 A
<ul style="list-style-type: none"> at 110 V rated value 	1 A
<ul style="list-style-type: none"> at 220 V rated value 	0.3 A
contact reliability of auxiliary contacts	1 faulty switching per 100 million (17 V, 1 mA)
UL/CSA ratings	
yielded mechanical performance [hp] for 3-phase AC motor at 460/480 V rated value	20 hp
Short-circuit protection	
design of the fuse link	
<ul style="list-style-type: none"> for short-circuit protection of the main circuit <ul style="list-style-type: none"> with type of coordination 1 required with type of coordination 2 required for short-circuit protection of the auxiliary switch required 	gL/gG LV HRC 3NA, DIAZED 5SB, NEOZED 5SE: 100 A gL/gG LV HRC 3NA, DIAZED 5SB, NEOZED 5SE: 35 A fuse gL/gG: 10 A
Installation/ mounting/ dimensions	
mounting position	+/-180° rotation possible on vertical mounting surface; can be tilted forward and backward by +/- 22.5° on vertical mounting surface
fastening method side-by-side mounting	Yes
fastening method	screw and snap-on mounting onto 35 mm DIN rail according to DIN EN 50022
height	85 mm
width	45 mm
depth	97 mm
required spacing	
<ul style="list-style-type: none"> with side-by-side mounting <ul style="list-style-type: none"> at the side 	0 mm
Connections/ Terminals	
type of electrical connection	
<ul style="list-style-type: none"> for main current circuit for auxiliary and control circuit 	screw-type terminals screw-type terminals
type of connectable conductor cross-sections for main contacts	
<ul style="list-style-type: none"> solid or stranded finely stranded with core end processing 	2x (1 ... 2.5 mm ²), 2x (2.5 ... 10 mm ²) 2x (1 ... 2.5 mm ²), 2x (2.5 ... 6 mm ²), 1x 10 mm ²
type of connectable conductor cross-sections	
<ul style="list-style-type: none"> for auxiliary contacts <ul style="list-style-type: none"> solid or stranded finely stranded with core end processing for AWG cables for auxiliary contacts 	2x (0.5 ... 1.5 mm ²), 2x (0.75 ... 2.5 mm ²) 2x (0.5 ... 1.5 mm ²), 2x (0.75 ... 2.5 mm ²) 2x (20 ... 16), 2x (18 ... 14)
Safety related data	
product function mirror contact according to IEC 60947-4-1	Yes
Electrical Safety	
protection class IP on the front according to IEC 60529	IP20
touch protection on the front according to IEC 60529	finger-safe, for vertical contact from the front
Approvals Certificates	
General Product Approval	EMV



[Confirmation](#)



Maritime application	other	Environment
----------------------	-------	-------------

[CCS \(China Classification Society\)](#)

[Confirmation](#)



[Environmental Confirmations](#)

Further information

Service&Support (Manuals, Certificates, Characteristics, FAQs,...)
<https://support.industry.siemens.com/cs/products?pnid=16027&lc=en-CN>

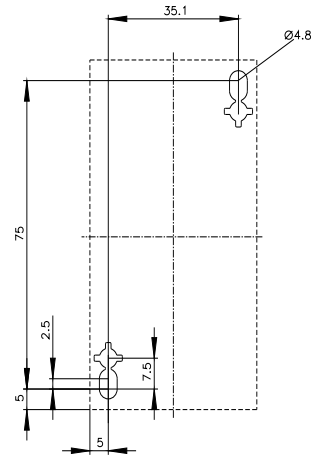
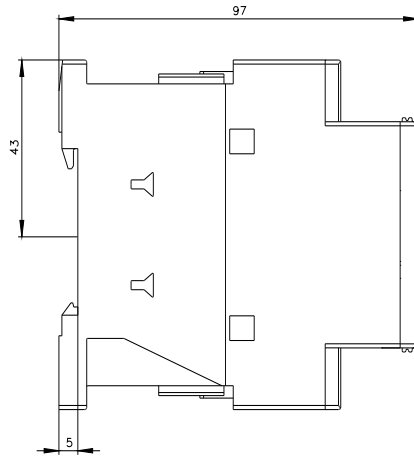
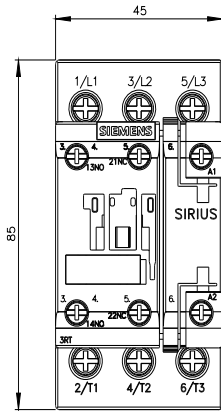



last modified:

4/4/2026