

SICK.COM



DATA SHEET

# OD1-B015H05I25

OD Mini  
Displacement measurement sensors

**SICK** Sensor Intelligence

DISPLACEMENT MEASUREMENT  
SENSORS

## OD1-B015H05I25

## ORDERING INFORMATION

Type	part no.
OD1-B015H05I25	6050496

Further device versions and accessories at [www.sick.com/OD\\_Mini](http://www.sick.com/OD_Mini)

## DETAILED TECHNICAL DATA

## FEATURES

Measuring range	10 mm ... 20 mm
Repeatability	1 $\mu\text{m}$ <sup>1) 2)</sup>
Linearity	$\pm 10 \mu\text{m}$ <sup>3)</sup>
Response time	$\geq 2 \text{ ms}$ <sup>4)</sup>
Measuring frequency	$\leq 2 \text{ kHz}$
Output time	$\geq 0.5 \text{ ms}$
Emitted beam	Light source Laser, red Typ. light spot size (distance) 700 $\mu\text{m}$ x 500 $\mu\text{m}$ (15 mm)
Key laser figures	Normative reference IEC 60825-1:2014, EN 60825-1:2014 Laser class 1 <sup>5)</sup> <sup>6)</sup>
Additional function	Averaging 1 ... 512x Automatic or manual sensitivity adjustment Analog outputs can be taught in Digital outputs can be taught in

<sup>1)</sup> Averaging function set to: 512.<sup>2)</sup> Constant ambient conditions.<sup>3)</sup> Measurement on 90 % remission (ceramic, white).<sup>4)</sup> With fixed sensitivity adjustment and averaging setting = 1. With automatic sensitivity and measuring rate 500  $\mu\text{s}$ : 2 ... 7.5 ms response time/measuring rate 1,000  $\mu\text{s}$ : 4 ... 15 ms response time.<sup>5)</sup> Wavelength: 655 nm, max. output: 390  $\mu\text{W}$  (laser class 1) / < 1 mW (laser class 2).<sup>6)</sup> Do not intentionally look into the laser beam. Never point the laser beam at people's eyes.

		Invertable digital output Switching mode: window (Wnd) Switching mode: distance to object (DtO) Switching mode: object between sensor and background (ObSB) Multifunctional input: laser-off / external teach-in / trigger
General notes	Note	Not free of paint wetting impairment substances.
Safety-related parameters	MTTF <sub>D</sub>	101 years
	DC <sub>avg</sub>	0%

<sup>1)</sup> Averaging function set to: 512.

<sup>2)</sup> Constant ambient conditions.

<sup>3)</sup> Measurement on 90 % remission (ceramic, white).

<sup>4)</sup> With fixed sensitivity adjustment and averaging setting = 1. With automatic sensitivity and measuring rate 500 µs: 2 ... 7.5 ms response time/measuring rate 1,000 µs: 4 ... 15 ms response time.

<sup>5)</sup> Wavelength: 655 nm, max. output: 390 µW (laser class 1) / < 1 mW (laser class 2).

<sup>6)</sup> Do not intentionally look into the laser beam. Never point the laser beam at people's eyes.

## INTERFACES

Digital output	Number	1
	Type	PNP/NPN, selectable
Analog output	Number	1
	Type	Current output
	Current	4 mA ... 20 mA, ≤ 300 Ω
	Resolution	13.4 bit
Multifunctional input (MF)		1 x <sup>1)</sup>

<sup>1)</sup> MF can be used as laser-off, trigger, external teach-in or deactivated.

## ELECTRONICS

Supply voltage U <sub>b</sub>	DC 12 V (-5 %) ... DC 24 V (+10 %)
Power consumption	≤ 1.92 W <sup>1)</sup>
Warm-up time	≤ 5 min
Display	4-digit 7-segment display (plus 4 LEDs for status display)
Enclosure rating	IP67
Protection class	III
Connection type	Cable with male connector, M12, 5-pin, 30 cm

<sup>1)</sup> Without load, with current output.

## MECHANICS

Dimensions (W x H x D)	17.8 mm x 44.4 mm x 31 mm
Control elements	4 buttons
Housing material	Stainless steel
Window material	Plastic (PPSU)
Weight	70 g

## AMBIENT DATA

Ambient temperature, operation	-10 °C ... +50 °C
Ambient temperature, storage	-20 °C ... +60 °C

# DISPLACEMENT MEASUREMENT SENSORS - OD1-B015H05I25

Min. rel. humidity (not condensing)	35 %
Max. rel. humidity (not condensing)	95 %
Temperature drift	± 0.08 % FS/K (FS = Full Scale = Measuring range of sensor)
Typ. Ambient light immunity	Artificial light: ≤ 3,000 lx Sunlight: ≤ 10,000 lx
Vibration resistance	10 Hz ... 55 Hz (amplitude 1.5 mm, x-, y-, z-axis 2 hours each)
Shock resistance	50 G (x, y, z axis 3 times each)

## CERTIFICATES

EU declaration of conformity	✓
UK declaration of conformity	✓
ACMA declaration of conformity	✓
Moroccan declaration of conformity	✓
China RoHS	✓
China Compulsory Product Certification (CCC) exempt	✓

## DIMENSIONAL DRAWING STAINLESS STEEL HOUSING

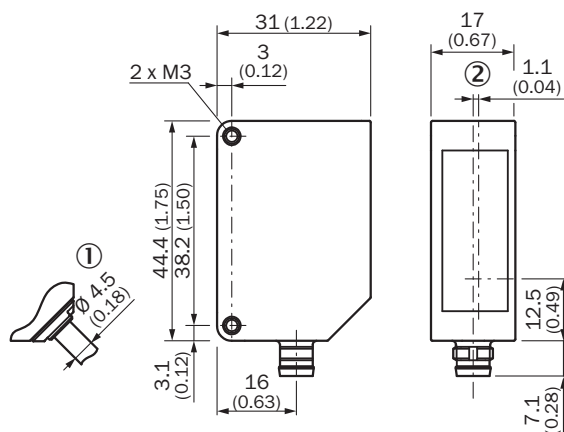

Dimensions in mm (inch)

① variant with 30 cm cable with M12, 5-pin connector

② Optical axis

## CONNECTION TYPE

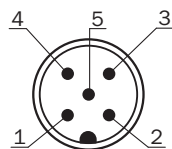

**CONNECTION DIAGRAM**

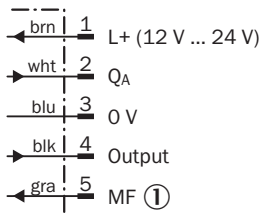

① Multifunctional input (MF)

**ADJUSTMENTS**

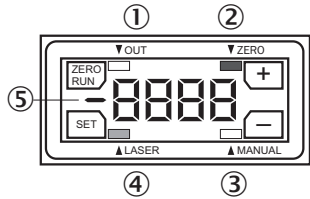

- ① digital output status indicator
- ② Zero offset status indicator
- ③ Teach mode status indicator
- ④ Laser status indicator
- ⑤ Minus sign for measured value indicator

**LIGHT SPOT SIZE OD MINI PRIME 10 MM ... 20 MM**

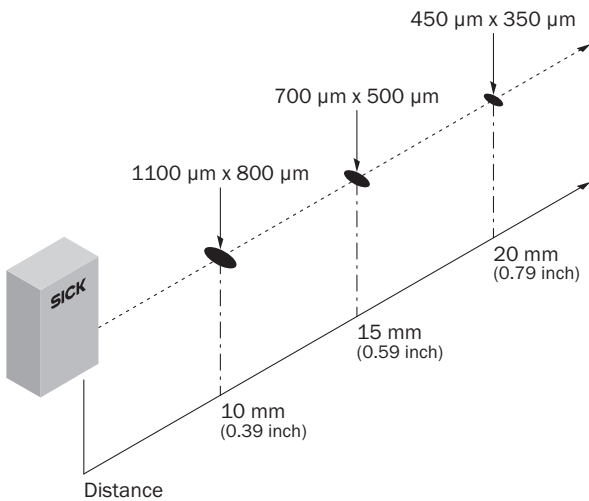

**LINEARITY**

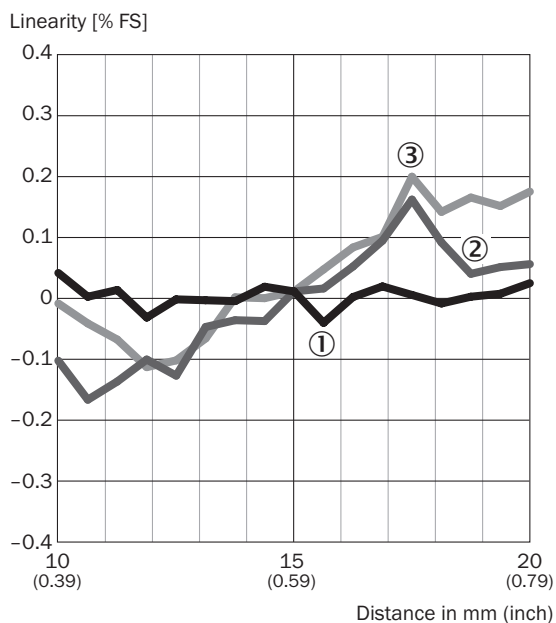

- ① White ceramic
- ② stainless steel
- ③ black rubber

Further information as well as suitable accessories, example applications and downloads such as CAD dimensional models, operating instructions and software can be found at [www.sick.com/6050496](http://www.sick.com/6050496)



SICK AG  
WALDKIRCH  
GERMANY  
SICK.COM

# SICK AT A GLANCE

SICK is a leading global technology company for intelligent sensors and integrated solutions in industrial automation. Our technologies set benchmarks, making your industrial processes more efficient, safer and more sustainable – both in logistics and manufacturing operations.

SICK combines sensor intelligence with industry expertise and certified consulting services. We provide the ideal foundation for scalable as well as tailor-made automation solutions and create added value along the entire value chain. Our close partnerships with our customers are more than just a promise: Together, we optimize productivity, improve quality, protect health and safety, and help build a sustainable future. All with empathy and trust.

Since 1946, we have been developing innovative technologies with passion and a pioneering spirit. With a global network in around 40 countries, SICK has a global presence and is always close by. The company's headquarters are located in Waldkirch near Freiburg, Germany. Our customers benefit from our understanding of both local and global requirements, which enables us to deliver tailor-made solutions

**SICK**  
Sensor Intelligence