

Solid State Contactors for Heaters

## G3PE-235B-3N DC12-24

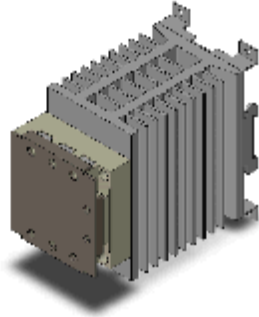

Image

Heater control, Input: 12 to 24 VDC, Output: 100 to 240 VAC, Load current: 35 A, Zero cross function, Screw terminal, DIN track mounting, Number of elements: 3

Product classification	For 3-phase Heater
Zero cross function	Equipped
Operating indicator	Equipped (Yellow)
Rated voltage	12 to 24 VDC
Rated load voltage	100 to 240 VAC
Load current	35 A (at 40 °C)
Terminal structure	Screw terminal

### Ratings / Performance

As of April 14, 2021

#### Ratings

Product classification		For 3-phase Heater
Number of phases		Three phase
Number of elements		3
Isolation method		Phototriac
Zero cross function		Equipped
Operating indicator		Equipped (Yellow)
Terminal structure		Screw terminal
Mounting		DIN track mounting
Input	Rated voltage	12 to 24 VDC
	Operating voltage range	9.6 to 30 VDC
	Input current	10 mA max. (at 24 VDC)
	Operate voltage	9.6 VDC max.
	Release voltage	1 VDC min.
Output	Rated load voltage	100 to 240 VAC
	Load voltage range	75 to 264 VAC
	Minimum load current	0.5 A
	Load current	35 A (at 40 °C)
	Inrush current resistivity	440 A (60 Hz 1 cycle)
	Permissible I2**t	1260 A <sup>2</sup> s
	Applicable load	Load carrying capacity

#### Performance

Operate time	1/2 cycle of load power source + 1 ms max.
Release time	1/2 cycle of load power source + 1 ms max.

<b>Output ON voltage drop</b>	1.6 V max. (RMS)
<b>Leakage current</b>	10 mA max. (at 200 VAC)
<b>Insulation resistance</b>	100 MΩ min. (at 500 VDC)
<b>Dielectric strength</b>	2500 VAC 50/60 Hz 1 min
<b>Vibration resistance</b>	10 to 55 to 10 Hz, 0.175 mm single amplitude (0.35 mm double amplitude)
<b>Shock resistance</b>	294 m/s <sup>2</sup> (98 m/s <sup>2</sup> with reverse mounting)
<b>Ambient temperature (Operating)</b>	-30 to 80 °C (with no freezing or condensation)
<b>Ambient temperature (Storage)</b>	-30 to 100 °C (with no freezing or condensation)
<b>Ambient humidity (Operating)</b>	45 to 85% RH
<b>Weight</b>	Approx. 1650 g

As of April 14, 2021

Outline drawing

As of April 14, 2021

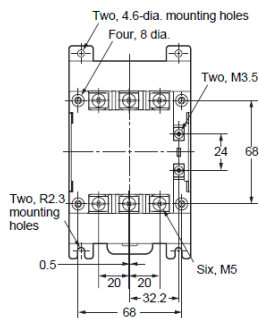

Note: Without terminal cover.

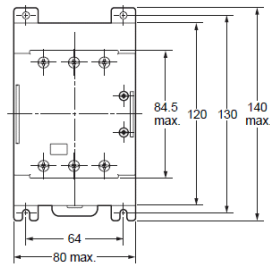

Note: With terminal cover.

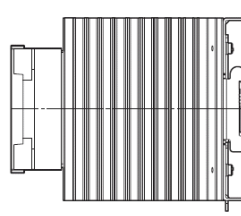
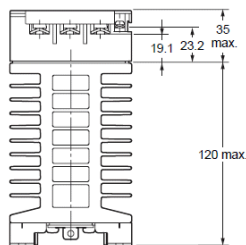

Mounting holes

### Mounting Holes

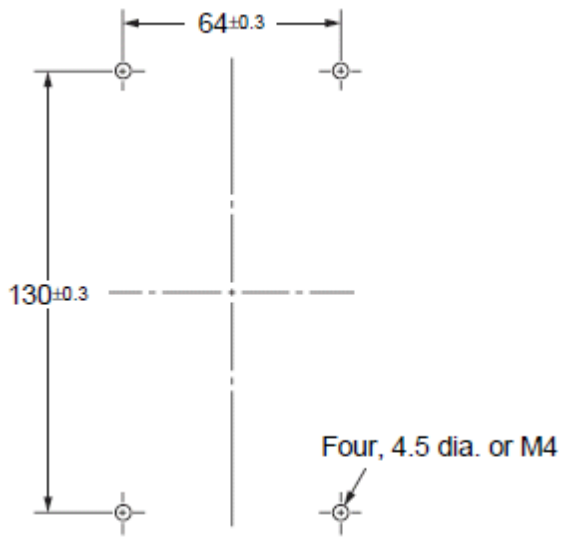

As of April 14, 2021

### Connection diagram

As of April 14, 2021

Terminal arrangement and internal connection

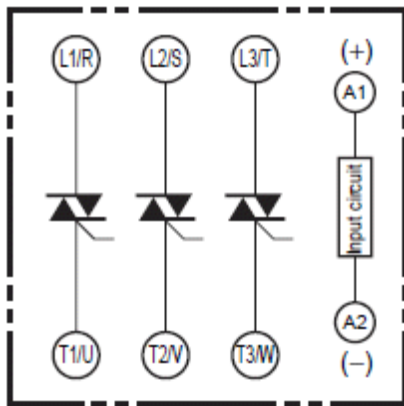

As of April 14, 2021

### Characteristic chart

As of April 14, 2021

Input Voltage vs. Input Impedance and Input Voltage vs. Input Current

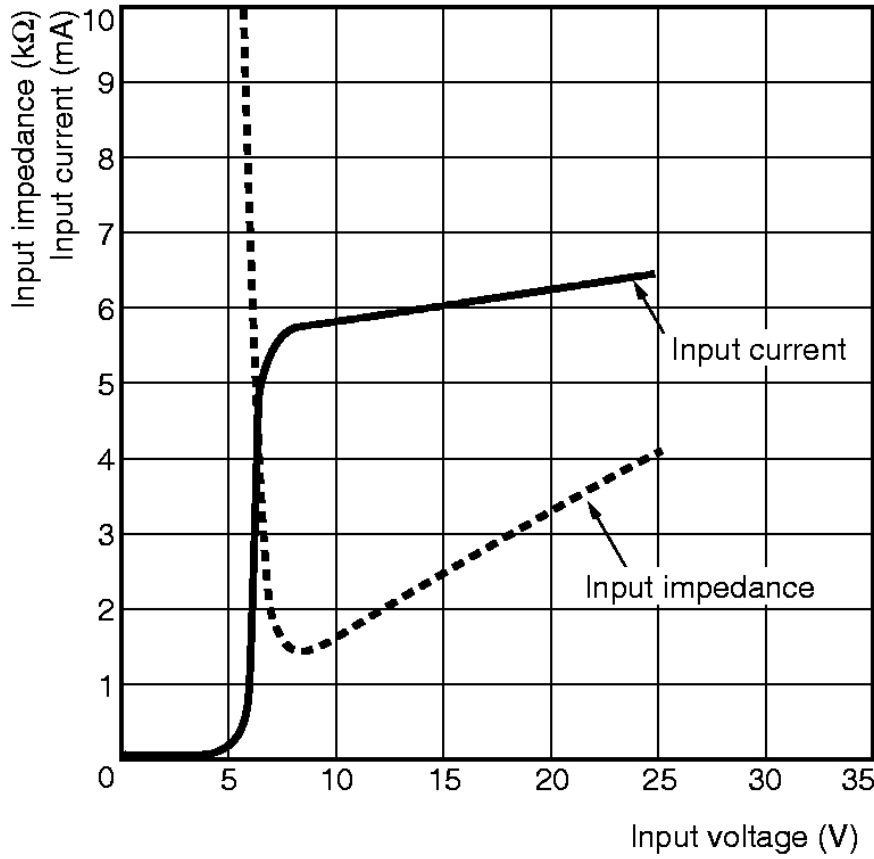

Load current-ambient temperature

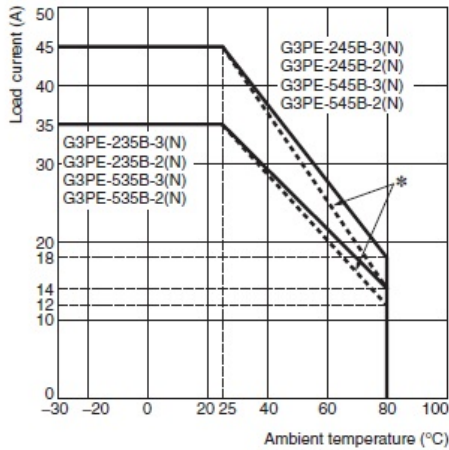

\* The dotted lines in the charts are the UL derating curves for the G3PE-235B-3(N), G3PE-245B-3(N), G3PE-235B-2(N), G3PE-245B-2(N), G3PE-535B-3(N), G3PE-545B-3(N), G3PE-535B-2(N), G3PE-545B-2(N).

Inrush current resistivity (Non-repetitive)

Keep the inrush current to below the inrush current resistance value (i.e., below the broken line) if it occurs repetitively.

**G3PE-235B-3(N)(H), G3PE-535B-3(N)(H)**  
**G3PE-235B-2(N)(H), G3PE-535B-2(N)(H)**  
**G3PE-245B-3(N)(H), G3PE-545B-3(N)(H)**  
**G3PE-245B-2(N)(H), G3PE-545B-2(N)(H)**

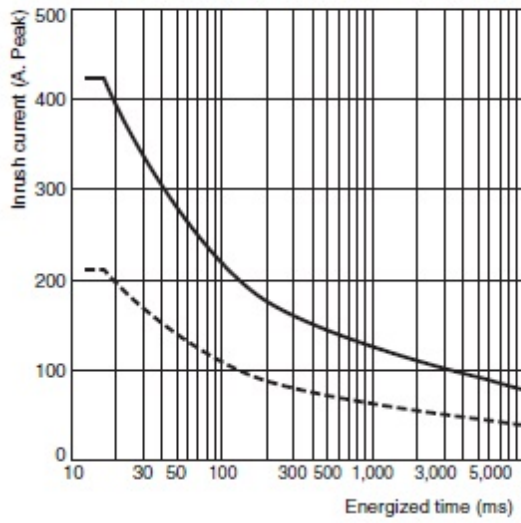

As of April 14, 2021