

Smart Fiber Amplifier Units E3X-ZV / MZV

Solidly Stable Presence/Absence Detection at an Amazing Price



- Low price is achieved by carefully selected functions and performance to those required to detect presence or absence.
- Minimum detectable object 3 μm and Response time 50 μs in super-high-speed mode.
E3X-ZV is reliable detection performance can be used for such as parts feeders and roll press for secondary battery sheet.
- Equipped with Smart Tuning, which adjustment of light intensity and threshold level to their optimal value is possible by just pressing the button twice.
- Cost-saving, Space-saving, Wiring-saving 2-channel models also available.
- New external input models allowing remote tuning can be used for a wider range of applications including mounters that require frequent changeovers.
- External input models with standby mode contribute to reducing power consumption of equipment.



For the most recent information on models that have been certified for safety standards, refer to your OMRON website.

 Refer to *Safety Precautions* on page 12.

Ordering Information

Fiber Amplifier Units [Refer to Dimensions on pages 13 to 16]

1-channel model

Type	Connecting method	Inputs/outputs	Model	
			NPN output	PNP output
Standard models	Pre-wired (2 m)	1 output	E3X-ZV11 2M	E3X-ZV41 2M
	Wire-saving Connector		E3X-ZV6	E3X-ZV8
External input models	Pre-wired (2 m)	1 output + 1 input	E3X-ZV21 2M	E3X-ZV51 2M
	Wire-saving Connector		E3X-ZV7	E3X-ZV9
Enhanced timer function models	Wire-saving Connector	1 output	E3X-ZV6M	E3X-ZV8M

2-channel model





Type	Connecting method	Inputs/outputs	Model	
			NPN output	PNP output
Standard models	Pre-wired (2 m)	2 outputs	E3X-MZV11 2M	E3X-MZV41 2M
	Wire-saving Connector		E3X-MZV6	E3X-MZV8
External input models	Pre-wired (2 m)	2 outputs + 2 inputs	E3X-MZV21 2M	E3X-MZV51 2M

Accessories (Sold Separately)

Wire-saving Connectors (Required for models for Wire-saving Connectors.) [Refer to *Dimensions* on page 16]

Connectors are not provided with the Fiber Amplifier Unit and must be ordered separately.

Note: Protective stickers are provided.

Type	Appearance	Cable length	No. of conductors	Model	Applicable Fiber Amplifier Units
Master Connector		2 m	3	E3X-CN11	E3X-ZV6 E3X-ZV8 E3X-ZV6M E3X-ZV8M
Slave Connector			1	E3X-CN12	
Master Connector			4	E3X-CN21	E3X-ZV7 E3X-ZV9 E3X-MZV6 E3X-MZV8
Slave Connector			2	E3X-CN22	

DIN Track [Refer to *Dimensions* on page 16]

A DIN Track is not provided with the Fiber Amplifier Unit. It must be ordered separately as required.

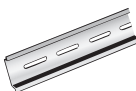
Type	Appearance	Model	Quantity
Shallow type, total length: 1 m		PFP-100N	1
Shallow type, total length: 0.5 m		PFP-50N	

Note: For details, refer to DIN Track on PFP-□ which can be accessed from your OMRON website.

Mounting Bracket [Refer to *Dimensions* on page 16]

A Mounting Bracket is not provided with the Fiber Amplifier Unit. It must be ordered separately as required.

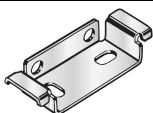
Appearance	Model	Quantity
	E39-L143	1

End Plate [Refer to *Dimensions* on page 16]

Two End Plates are provided with the Sensor Communications Unit. End Plates are not provided with the Fiber Amplifier Unit. They must be ordered separately as required.

Appearance	Model	Quantity
	PFP-M	1

Note: 1. The minimum ordering quantity is 10.

2. For details, refer to End Plate on PFP-M which can be accessed from your OMRON website.

Ratings and Specifications

1-channel model

Item	Type	Standard models/Enhanced timer function models		External input models	
	NPN output	E3X-ZV11	E3X-ZV6/ZV6M	E3X-ZV21	E3X-ZV7
	PNP output	E3X-ZV41	E3X-ZV8/ZV8M	E3X-ZV51	E3X-ZV9
	Connecting method	Pre-wired	Wire-saving Connector *1	Pre-wired	Wire-saving Connector *1
Inputs/outputs	1 output			1 output + 1 input *2	
Light source (wavelength)	Red, 4-element LED (625 nm)				
Power supply voltage	12 to 24 VDC \pm 10%, ripple (p-p) 10% max.				
Power consumption	Normal mode: 720 mW max. (Power supply voltage 24 V: Current consumption 30 mA max. / Power supply voltage 12 V: Current consumption 60 mA max.) Eco function ON: 530 mW max. (Power supply voltage 24 V: Current consumption 22 mA max. / Power supply voltage 12 V: Current consumption 44 mA max.) Eco function Standby: 390 mW max. (Power supply voltage 24 V: Current consumption 16 mA max. / Power supply voltage 12 V: Current consumption 32 mA max.)			Normal mode: 720 mW max. (Power supply voltage 24 V: Current consumption 30 mA max. / Power supply voltage 12 V: Current consumption 60 mA max.) Eco function ON: 530 mW max. (Power supply voltage 24 V: Current consumption 22 mA max. / Power supply voltage 12 V: Current consumption 44 mA max.) Eco function Standby: 390 mW max. (Power supply voltage 24 V: Current consumption 16 mA max. / Power supply voltage 12 V: Current consumption 32 mA max.)	
Control output	Load power supply voltage: 26.4 VDC, open collector output type (NPN or PNP output differs depending on the type.) Load current: 100 mA max. (Residual voltage: Load current less than 10 mA: 1 V max., load current 10 to 100 mA: 2 V max.) OFF current: 0.1 mA max.				
Indicators	7-segment displays (Threshold Level display: green, Incident Light Level display: red) Display direction: Switchable between normal and reversed. Smart Tuning Indicator (green) OUT indicator (orange)				
Protection circuits	Power supply reverse polarity protection, output short-circuit protection and output reverse polarity protection				
Response time	Super-high-speed mode (SHS)	Operate or reset: 50 μ s			
	High-speed mode (HS)	Operate or reset: 250 μ s *3			
	Standard mode (Std)	Operate or reset: 1 ms *4			
	Giga-power mode (GIGA)	Operate or reset: 16 ms			
Sensitivity adjustment	Smart Tuning (2-point tuning, power tuning, percentage tuning (-99% to 99%), maximum sensitivity tuning, full auto tuning, position tuning) or manual adjustment				
Mutual interference prevention function	Emission cycle setting switching type (up to 4 units)				
Functions	DPC (Dynamic Power Control)	Yes			
	ATC (Active Threshold Control)	Yes			
	Timer	Select from timer disabled, OFF-delay, ON-delay, one-shot or On/Off-delay Timer *5 E3X-ZV11/41/6/8/21/7/9: 1 to 9,999 ms E3X-ZV6M/8M: 0.1 to 9,999 ms			
	Zero reset	Negative values can be displayed. (Threshold value is shifted.)			
	Resetting settings	Select from initial reset (factory defaults) or user reset (saved settings).			
	Eco mode	Select from OFF (digital display lit) and Eco ON (digital display not lit).		Select from OFF (digital display lit), Eco ON (digital display not lit) and Standby (digital display not lit, emission stop).	
	Power tuning	Select from ON or OFF.			
Ambient illumination (Receiver side)	Incandescent lamp: 20,000 lx max., Sunlight: 30,000 lx max.				
Ambient temperature range	Operating: -25°C to 55°C Storage: -30°C to 70°C (with no icing or condensation)				
Ambient humidity range	Operating and storage: 35 to 85% (with no condensation) within the surrounding air temperature range shown above				
Insulation resistance	20 M Ω min. (at 500 VDC)				
Dielectric strength	1,000 VAC at 50/60 Hz for 1 min				
Vibration resistance (destruction)	10 to 55 Hz with a 1.5-mm double amplitude for 2 hours each in X, Y, and Z directions				
Shock resistance (destruction)	500 m/s ² for 3 times each in X, Y, and Z directions				
Weight (packed state/Sensor only)	Approx. 95 g/approx. 65 g	Approx. 45 g/approx. 20 g	Approx. 95 g/approx. 65 g	Approx. 45 g/approx. 20 g	
Materials	Case	Polycarbonate (PC).			
	Cover	Polycarbonate (PC)			
	Cable	PVC			
Accessories	Instruction manual, Compliance sheet				

*1. One of the E3X-CN11 (bus-connector with 3 wires), E3X-CN12 (sub-connector with 1 wires)

*2. The following details apply to the input.

	Contact input (relay or switch)	Non-contact input (transistor)	Input time
NPN	ON: Shorted to 0 V (Sourcing current: 1 mA max.). OFF: Open or shorted to Vcc.	ON: 1.5 V max. (Sourcing current: 1 mA max.) OFF: Vcc - 1.5 V to Vcc (Leakage current: 0.1 mA max.)	ON: 100 ms min. OFF: 100 ms min.
PNP	ON: Shorted to Vcc (Sinking current: 3 mA max.). OFF: Open or shorted to 0 V.	ON: Vcc - 1.5 V to Vcc (Sinking current: 3 mA max.) OFF: 1.5 V max. (Leakage current: 0.1 mA max.)	

*3. Mutual interference prevention function in the Response Time Priority Mode: 2 units: 350 μ s; 3 units: 400 μ s / In the Unit Number Priority Mode: 4 units: 700 μ s

*4. Mutual interference prevention function in the Unit Number Priority Mode: 4 units: 1.6 ms

*5. Only E3X-ZV6M/ZV8M can be selected.

2-channel model

Item	Type	Standard models		External input models	
		NPN output	E3X-MZV11	E3X-MZV6	E3X-MZV21
		PNP output	E3X-MZV41	E3X-MZV8	E3X-MZV51
	Connecting method	Pre-wired	Wire-saving Connector *1	Pre-wired	
Inputs/outputs		2 output		2 outputs + 2 inputs *2	
Light source (wavelength)		Red, 4-element LED (625 nm)			
Power supply voltage		12 to 24 VDC ±10%, ripple (p-p) 10% max.			
Power consumption		Normal mode: 820 mW max. (Power supply voltage 24 V: Current consumption 35 mA max. / Power supply voltage 12 V: Current consumption 69 mA max.) Eco function ON: 600 mW max. (Power supply voltage 24 V: Current consumption 25 mA max. / Power supply voltage 12 V: Current consumption 50 mA max.) Eco function Standby: 480 mW max. (Power supply voltage 24 V: Current consumption 20 mA max. / Power supply voltage 12 V: Current consumption 40 mA max.)		Normal mode: 820 mW max. (Power supply voltage 24 V: Current consumption 35 mA max. / Power supply voltage 12 V: Current consumption 69 mA max.) Eco function ON: 600 mW max. (Power supply voltage 24 V: Current consumption 25 mA max. / Power supply voltage 12 V: Current consumption 50 mA max.) Eco function Standby: 480 mW max. (Power supply voltage 24 V: Current consumption 20 mA max. / Power supply voltage 12 V: Current consumption 40 mA max.)	
Control output		Load power supply voltage: 26.4 VDC, open collector output type (NPN or PNP output differs depending on the type.) Load current: 100 mA max. (Residual voltage: Load current less than 10 mA: 1 V max., load current 10 to 100 mA: 2 V max.) OFF current: 0.1 mA max.			
Indicators		7-segment displays (Threshold Level display: green, Incident Light Level display: red) Display direction: Switchable between normal and reversed. Smart Tuning Indicator (green) OUT1/2 indicator (orange), CH Indicator (green)			
Protection circuits		Power supply reverse polarity protection, output short-circuit protection and output reverse polarity protection			
Response time	Super-highspeed mode (SHS)	Operate or reset: 100 μs			
	High-speed mode (HS)	Operate or reset: 250 μs *3			
	Standard mode (Std)	Operate or reset: 1 ms *4			
	Giga-power mode (GIGA)	Operate or reset: 16 ms			
Sensitivity adjustment		Smart Tuning (2-point tuning, power tuning, percentage tuning (-99% to 99%), maximum sensitivity tuning, full auto tuning, position tuning) or manual adjustment			
Mutual interference prevention function		Emission cycle setting switching type (up to 2 units) Or, up to 2 units for E3X-ZV (the Unit Number Priority Mode), and 1 unit for E3X-MZV.			
Functions	DPC (Dynamic Power Control)	Yes			
	ATC (Active Threshold Control)	Yes			
	Timer	Select from timer disabled, OFF-delay, ON-delay or one-shot timer: 1 to 9,999 ms			
	Zero reset	Negative values can be displayed. (Threshold value is shifted.)			
	Resetting settings	Select from initial reset (factory defaults) or user reset (saved settings).			
	Eco mode	Select from OFF (digital display lit) and Eco ON (digital display not lit).	Select from OFF (digital display lit), Eco ON (digital display not lit) and Standby (digital display not lit, emission stop).		
	Power tuning	Select from ON or OFF.			
Ambient illumination (Receiver side)		Incandescent lamp: 20,000 lx max., Sunlight: 30,000 lx max.			
Ambient temperature range		Operating: -25°C to 55°C Storage: -30°C to 70°C (with no icing or condensation)			
Ambient humidity range		Operating and storage: 35 to 85% (with no condensation) within the surrounding air temperature range shown above			
Insulation resistance		20 MΩ min. (at 500 VDC)			
Dielectric strength		1,000 VAC at 50/60 Hz for 1 min			
Vibration resistance (destruction)		10 to 55 Hz with a 1.5-mm double amplitude for 2 hours each in X, Y, and Z directions			
Shock resistance (destruction)		500 m/s ² for 3 times each in X, Y, and Z directions			
Weight (packed state/Sensor only)		Approx. 100 g/approx. 75 g	Approx. 45 g/approx. 20 g	Approx. 100 g/approx. 75 g	
Materials	Case	Polycarbonate (PC).			
	Cover	Polycarbonate (PC)			
	Cable	PVC			
Accessories		Instruction manual, Compliance sheet			

*1. One of the E3X-CN21 (bus-connector with 4 wires), E3X-CN22 (sub-connector with 2 wires)

*2. The following details apply to the input.

	Contact input (relay or switch)	Non-contact input (transistor)	Input time
NPN	ON: Shorted to 0 V (Sourcing current: 1 mA max.). OFF: Open or shorted to Vcc.	ON: 1.5 V max. (Sourcing current: 1 mA max.) OFF: Vcc - 1.5 V to Vcc (Leakage current: 0.1 mA max.)	ON: 100 ms min. OFF: 100 ms min.
PNP	ON: Shorted to Vcc (Sinking current: 3 mA max.). OFF: Open or shorted to 0 V.	ON: Vcc - 1.5 V to Vcc (Sinking current: 3 mA max.) OFF: 1.5 V max. (Leakage current: 0.1 mA max.)	

*3. When using Mutual interference prevention function: 700 μs

*4. When using Mutual interference prevention function: 1.6 ms

Sensing Distances

Threaded Models

Sensing method	Sensing direction	Size	Model	Sensing distance (mm)			
				Giga mode	Standard mode	High-speed mode	Super-high-speed mode
Through-beam	Right-angle	M4	E32-T11N 2M	2,000	1,000	700	280
			E32-LT11N 2M	4,000 *	3,500	2,300	920
	Straight		E32-T11R 2M	2,000	1,000	700	280
			E32-LT11 2M	4,000 *	4,000 *	2,700	1,080
			E32-LT11R 2M	4,000 *	3,500	2,300	920
Reflective	Right-angle	M3	E32-C31N 2M	110	50	46	14
			E32-C21N 2M	290	130	90	39
		M4	E32-D21N 2M	840	350	240	100
			E32-C11N 2M	780	350	320	100
		M6	E32-LD11N 2M	840	350	240	100
			E32-D21R 2M	140	60	40	16
	Straight	M3	E32-C31 2M	330	150	100	44
			E32-C31M 1M				
			M4	E32-D211R 2M	140	60	40
		E32-D11R 2M		840	350	240	100
		M6	E32-CC200 2M	1,400	600	400	180
			E32-LD11 2M	860	360	250	110
			E32-LD11R 2M	840	350	240	100

* The fiber length is 2 m on each side, so the sensing distance is given as 4,000 mm.

Cylindrical Models

Sensing method	Size	Sensing direction	Model	Sensing distance (mm)			
				Giga mode	Standard mode	High-speed mode	Super-high-speed mode
Through-beam	1 dia.	Top-view	E32-T223R 2M	450	250	150	60
	1.5 dia.		E32-T22B 2M	680	400	220	90
	3 dia.		E32-T12R 2M	2,000	1,000	700	280
	Reflective	1.5 dia.	Side-view	E32-T14LR 2M	750	450	260
E32-D22B 2M				140	60	40	16
1.5 dia. + 0.5 dia.		Top-view	E32-D43M 1M	28	12	8	4
			E32-D22R 2M	140	60	40	16
E32-D221B 2M			300	140	90	40	
3 dia.			E32-D32L 2M	700	300	200	90
			E32-D33 2M	70	30	20	8
3 dia. + 0.8 dia.							

Flat Models

Sensing method	Sensing direction	Model	Sensing distance (mm)			
			Giga mode	Standard mode	High-speed mode	Super-high-speed mode
Through-beam	Top-view	E32-T15XR 2M	2,000	1,000	700	280
	Side-view	E32-T15YR 2M	750	450	260	100
	Flat-view	E32-T15ZR 2M				
Reflective	Top-view	E32-D15XR 2M	840	350	240	100
	Side-view	E32-D15YR 2M	200	100	52	24
	Flat-view	E32-D15ZR 2M				

Sleeve Models

Sensing method	Sensing direction	Model	Sensing distance (mm)			
			Giga mode	Standard mode	High-speed mode	Super-high-speed mode
Through-beam	Side-view	E32-T24R 2M	170	100	50	20
		E32-T24E 2M	450	250	150	60
	Top-view	E32-T33 1M	150	90	50	20
		E32-T21-S1 2M	510	300	170	68
		E32-TC200BR 2M	2,000	1,000	700	280
Reflective	Side-view	E32-D24R 2M	70	30	20	8
		E32-D24-S2 2M	120	53	45	14
	Top-view	E32-D43M 1M	28	12	8	4
		E32-D331 2M	14	6	4	2
		E32-D33 2M	70	30	20	8
		E32-D32-S1 0.5M	63	27	18	7
		E32-D31-S1 0.5M				
		E32-DC200F4R 2M	140	60	40	16
		E32-D22-S1 2M	250	110	72	30
		E32-D21-S3 2M				
		E32-DC200BR 2M	840	350	240	100
		E32-D25-S3 2M	250	110	72	30

Small-spot, Reflective Models

Type	Spot diameter	Center distance (mm)	Model	Sensing distance (mm)			
				Giga mode	Standard mode	High-speed mode	Super-high-speed mode
Variable spot	0.1 to 0.6 dia.	6 to 15	E32-C42 1M+E39-F3A	Spot diameter of 0.1 to 0.6 mm at 6 to 15 mm.			
	0.3 to 1.6 dia.	10 to 30	E32-C42 1M+E39-F17	Spot diameter of 0.3 to 1.6 mm at 10 to 30 mm.			
Parallel light	4 dia.	0 to 20	E32-C31 2M+E39-F3C	Spot diameter of 4 mm max. at 0 to 20 mm.			
			E32-C31N 2M+E39-F3C				
Integrated lens	0.1 dia.	5	E32-C42S 1M	Spot diameter of 0.1 mm at 5 mm.			
	6 dia.	50	E32-L15 2M	Spot diameter of 6 mm at 50 mm.			
Small-spot	0.1 dia.	7	E32-C41 1M+E39-F3A-5	Spot diameter of 0.1 mm at 7 mm.			
	0.5 dia.		E32-C31 2M+E39-F3A-5	Spot diameter of 0.5 mm at 7 mm.			
			E32-C31N 2M+E39-F3A-5				
	0.2 dia.	17	E32-C41 1M+E39-F3B	Spot diameter of 0.2 mm at 17 mm.			
	0.5 dia.		E32-C31 2M+E39-F3B	Spot diameter of 0.5 mm at 17 mm.			
	3 dia.	50	E32-CC200 2M+E39-F18				
E32-C11N 2M+E39-F18							

High-power Beam Models

Type	Sensing direction	Aperture angle	Model	Sensing distance (mm)			
				Giga mode	Standard mode	High-speed mode	Super-high-speed mode
Through-beam models with integrated lens	Right-angle	15°	E32-LT11N 2M	4,000 *2	3,500	2,300	920
		10°	E32-T17L 10M	20,000 *1	20,000 *1	20,000 *1	8,000
	Top-view	15°	E32-LT11 2M	4,000 *2	4,000 *2	2,700	1,080
			E32-LT11R 2M	4,000 *2	3,500	2,300	920
Side-view	30°	E32-T14 2M	4,000 *2	4,000 *2	4,000 *2	1,800	
Through-beam models with lenses	Right-angle	12°	E32-T11N 2M+E39-F1	4,000 *2	4,000 *2	4,000 *2	2,000
		6°	E32-T11N 2M+E39-F16	4,000 *2	4,000 *2	4,000 *2	3,600
	Top-view	12°	E32-T11R 2M+E39-F1	4,000 *2	4,000 *2	4,000 *2	2,000
			6°	E32-T11R 2M+E39-F16	4,000 *2	4,000 *2	4,000 *2
	Side-view	60°	E32-T11R 2M+E39-F2	1,450	800	500	200
	Top-view	12°	E32-T11 2M+E39-F1	4,000 *2	4,000 *2	4,000 *2	1,860
			6°	E32-T11 2M+E39-F16	4,000 *2	4,000 *2	4,000 *2
	Side-view	60°	E32-T11 2M+E39-F2	2,300	1,320	860	320
	Top-view	12°	E32-T51R 2M+E39-F1	4,000 *2	4,000 *2	3,900	1,500
			6°	E32-T51R 2M+E39-F16	4,000 *2	4,000 *2	4,000 *2
	Side-view	60°	E32-T51R 2M+E39-F2	1,400	720	500	200
	Top-view	12°	E32-T81R-S 2M+E39-F1	4,000 *2	4,000 *2	2,700	1,000
			6°	E32-T81R-S 2M+E39-F16	4,000 *2	4,000 *2	4,000 *2
	Side-view	60°	E32-T81R-S 2M+E39-F2	1,000	550	360	140
	Top-view	12°	E32-T61-S 2M+E39-F1	4,000 *2	4,000 *2	4,000 *2	1,800
			6°	E32-T61-S 2M+E39-F16	4,000 *2	4,000 *2	4,000 *2
Side-view	60°	E32-T61-S 2M+E39-F2	1,680	900	600	240	
Top-view	12°	E32-T51 2M+E39-F1-33	4,000 *2	4,000 *2	2,300	1,400	
		6°	E32-T51 2M+E39-F16	4,000 *2	4,000 *2	4,000 *2	4,000 *2
Reflective models with integrated lens	Top-view	4°	E32-D16 2M	40 to 2,800	40 to 1,400	40 to 900	40 to 480

*1. The fiber length is 10 m on each side, so the sensing distance is given as 20,000 mm.

*2. The fiber length is 2 m on each side, so the sensing distance is given as 4,000 mm.

Narrow View Models

Sensing method	Sensing direction	Aperture angle	Model	Sensing distance (mm)			
				Giga mode	Standard mode	High-speed mode	Super-high-speed mode
Through-beam	Side-view	1.5°	E32-A03 2M	3,220	1,780	1,200	500
			E32-A03-1 2M				
		3.4°	E32-A04 2M	1,280	680	450	200
		4°	E32-T24SR 2M	4,000 *	2,200	1,460	580
			E32-T24S 2M	4,000 *	2,600	1,740	700
			E32-T22S 2M	4,000 *	3,800	2,500	1,000

* The fiber length is 2 m on each side, so the sensing distance is given as 4,000 mm.

Models for Detection without Background Interference

Sensing method	Sensing direction	Model	Sensing distance (mm)			
			Giga mode	Standard mode	High-speed mode	Super-high-speed mode
Limited-reflective	Flat-view	E32-L16-N 2M	0 to 15			0 to 12
		E32-L24S 2M	0 to 4			
	Side-view	E32-L25L 2M	5.4 to 9 (center 7.2)			

Transparent Object Detection (Retro-reflective Models)

Sensing method	Feature	Size	Model	Sensing distance (mm)			
				Giga mode	Standard mode	High-speed mode	Super-high-speed mode
Retro-reflective	Film detection	M3	E32-C31 2M +E39-F3R +E39-RP37	250		200	---
	Square	---	E32-R16 5M	150 to 1,500			
	Threaded	M6	E32-R21 2M	10 to 250			
	Hex-shaped		E32-LR11NP 2M +E39-RP1	1,350	1,200	1,000	550

Transparent Object Detection (Limited-reflective Models)

Sensing method	Feature	Sensing direction	Model	Sensing distance (mm)			
				Giga mode	Standard mode	High-speed mode	Super-high-speed mode
Limited-reflective	Small size	Flat-view	E32-L24S 2M	0 to 4			
	Standard		E32-L16-N 2M	0 to 15			0 to 12
	Glass substrate alignment, 70°C		E32-A08 2M	10 to 20			---
	Standard/long-distance		E32-A12 2M	12 to 30			---
	Side-view form	Side-view	E32-L25L 2M	5.4 to 9 (center 7.2)			
	Glass substrate mapping, 70°C	Top-view	E32-A09 2M	15 to 38			---

Chemical-resistant, Oil-resistant Models

Sensing method	Type	Sensing direction	Model	Sensing distance (mm)			
				Giga mode	Standard mode	High-speed mode	Super-high-speed mode
Through-beam	Oil-resistant	Right-angle	E32-T11NF 2M	4,000 *1	4,000 *1	4,000 *1	2,200
	Chemical/oil-resistant	Top-view	E32-T12F 2M	4,000 *1	4,000 *1	4,000 *1	1,600
		Side-view	E32-T11F 2M	4,000 *1	4,000 *1	2,600	1,000
			E32-T14F 2M	1,400	800	500	200
	Chemical/oil-resistant at 150°C	Top-view	E32-T51F 2M	4,000 *1	2,800	1,800	700
Reflective	Semiconductors: Cleaning, developing, and etching; 60°C	Top-view	E32-L11FP 5M	8 to 20 mm from tip of lens (Recommended sensing distance: 11 mm), 19 to 31 mm from center of mounting hole A (Recommended sensing distance: 22 mm)			
	Semiconductors: Resist stripping; 85°C		E32-L11FS 5M	8 to 20 mm from tip of lens (Recommended sensing distance: 11 mm), 32 to 44 mm from center of mounting hole A (Recommended sensing distance: 35 mm)			
	Chemical/oil-resistant		E32-D12F 2M	---	190	130	60
	Chemical-resistant cable		E32-D11U 2M	840	350	240	100

*1. The fiber length is 2 m on each side, so the sensing distance is given as 4,000 mm.

*2. Even if there is no sensing object, the Sensor will detect light that is reflected by the fluoro-resin.

Bending-resistant Models

Sensing method	Size	Model	Sensing distance (mm)			
			Giga mode	Standard mode	High-speed mode	Super-high-speed mode
Through-beam	1.5 dia.	E32-T22B 2M	680	400	220	90
	M3	E32-T21 2M				
	M4	E32-T11 2M	2,500	1,350	900	360
	Square	E32-T25XB 2M	500	300	170	70
Reflective	1.5 dia.	E32-D22B 2M	140	60	40	16
	M3	E32-D21 2M				
	3 dia.	E32-D221B 2M	300	140	90	40
	M4	E32-D21B 2M				
	M6	E32-D11 2M	840	350	240	100
	Square	E32-D25XB 2M	240	100	60	30

Heat-resistant Models

Sensing method	Size	Model	Sensing distance (mm)				
			Giga mode	Standard mode	High-speed mode	Super-high-speed mode	
Through-beam	100°C	E32-T51R 2M	1,600	800	560	225	
	150°C	E32-T51 2M	2,800	1,500	1,000	400	
	200°C	E32-T81R-S 2M	1,000	550	360	140	
	350°C	E32-T61-S 2M	1,680	900	600	240	
Reflective	100°C	E32-D51R 2M	670	280	190	80	
	150°C	E32-D51 2M	1,120	450	320	144	
	200°C	E32-D81R-S 2M	420	180	120	54	
	300°C	E32-A08H2 2M	10 to 20				---
		E32-A09H2 2M	20 to 30 (center 25)				---
	350°C	E32-D611-S 2M	420	180	120	54	
		E32-D61-S 2M					
	400°C	E32-D73-S 2M	280	120	80	36	

Area Detection Models

Sensing method	Type	Sensing width	Model	Sensing distance (mm)			
				Giga mode	Standard mode	High-speed mode	Super-high-speed mode
Through-beam	Area	11 mm	E32-T16PR 2M	3,100	1,700	1,120	440
			E32-T16JR 2M	2,750	1,500	960	380
		E32-T16WR 2M	4,000 *	2,600	1,700	680	
Reflective	Array	11 mm	E32-D36P1 2M	700	300	200	90

* The fiber length is 2 m on each side, so the sensing distance is given as 4,000 mm.

Liquid-level Detection Models

Sensing method	Tube diameter	Feature	Model	Sensing distance (mm)			
				Giga mode	Standard mode	High-speed mode	Super-high-speed mode
Tube-mounting	3.2, 6.4, or 9.5 dia.	Stable residual quantity detection	E32-A01 5M	Applicable tube: Transparent tube with a diameter of 3.2, 6.4, or 9.5 mm, Recommended wall thickness: 1 mm			
	8 to 10 dia.	Mounting at multiple levels	E32-L25T 2M	Applicable tube: Transparent tube with a diameter of 8 to 10 mm, Recommended wall thickness: 1 mm			
	No restrictions	Large tubes	E32-D36T 5M	Applicable tube: Transparent tube (no restrictions on diameter)			
Liquid contact (heat-resistant up to 200°C)	---	---	E32-D82F1 4M	Liquid-contact type			

Vacuum-resistant Models

Sensing method	Heat-resistant temperature	Model	Sensing distance (mm)			
			Giga mode	Standard mode	High-speed mode	Super-high-speed mode
Through-beam	120°C	E32-T51V 1M	720	400	260	100
		E32-T51V 1M+E39-F1V	2,000 *	2,000 *	1,360	520
	200°C	E32-T84SV 1M	1,760	950	640	260

* The fiber length is 1 m on each side, so the sensing distance is given as 2,000 mm.

Models for FPD, Semiconductors, and Solar Cells

Sensing method	Application	Operating temperature	Model	Sensing distance (mm)			
				Giga mode	Standard mode	High-speed mode	Super-high-speed mode
Limited-reflective	Glass presence detection	70°C	E32-L16-N 2M	0 to 15			0 to 12
			E32-A08 2M	10 to 20			---
	Glass substrate alignment	300°C	E32-A08H2 3M	12 to 30			---
			E32-A12 2M	15 to 38			---
	Glass substrate mapping	300°C	E32-A09 2M	20 to 30 (center 25)			---
			E32-A09H2 2M				---
Through-beam	Wafer mapping	70°C	E32-L11FP 5M	8 to 20 mm from tip of lens (Recommended sensing distance: 11 mm), 19 to 31 mm from center of mounting hole A (Recommended sensing distance: 22 mm)			
			E32-L11FS 5M	8 to 20 mm from tip of lens (Recommended sensing distance: 11 mm), 32 to 44 mm from center of mounting hole A (Recommended sensing distance: 35 mm)			
Through-beam	Wafer mapping	70°C	E32-A03 2M	3,220	1,780	1,200	500
			E32-A03-1 2M				
			E32-A04 2M	1,280	680	450	200
			E32-T24SR 2M	4,000 *	2,200	1,460	580
			E32-T24S 2M	4,000 *	2,600	1,740	700

* The fiber length is 2 m on each side, so the sensing distance is given as 4,000 mm.

I/O Circuit Diagrams

NPN Output

Model	Operation mode	Timing chart	Output circuit
E3X-ZV11 E3X-ZV6 E3X-ZV6M	Light-ON		
	Dark-ON		
E3X-ZV21 E3X-ZV7	Light-ON		
	Dark-ON		
E3X-MZV11 E3X-MZV6	Light-ON		
	Dark-ON		
E3X-MZV21	Light-ON		
	Dark-ON		

*1. For E3X-ZV7, this will be orange.

PNP Output

Model	Operation mode	Timing chart	Output circuit
E3X-ZV41 E3X-ZV8 E3X-ZV8M	Light-ON		
	Dark-ON		
E3X-ZV51 E3X-ZV9	Light-ON		
	Dark-ON		<p>*1. For E3X-ZV9, this will be orange.</p>
E3X-MZV41 E3X-MZV8	Light-ON		
	Dark-ON		
E3X-MZV51	Light-ON		
	Dark-ON		

Nomenclature

E3X-ZV11
 E3X-ZV21
 E3X-ZV41
 E3X-ZV51
 E3X-ZV6
 E3X-ZV6M
 E3X-ZV7
 E3X-ZV8
 E3X-ZV8M
 E3X-ZV9

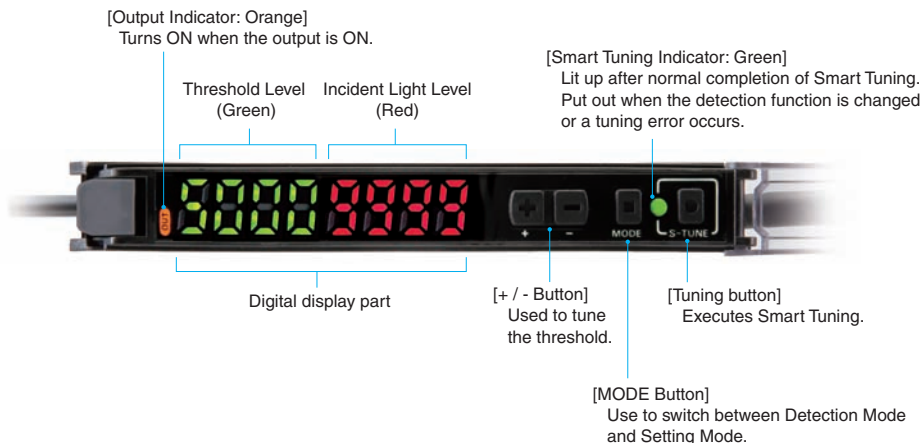

E3X-MZV11
 E3X-MZV21
 E3X-MZV41
 E3X-MZV51
 E3X-MZV6
 E3X-MZV8

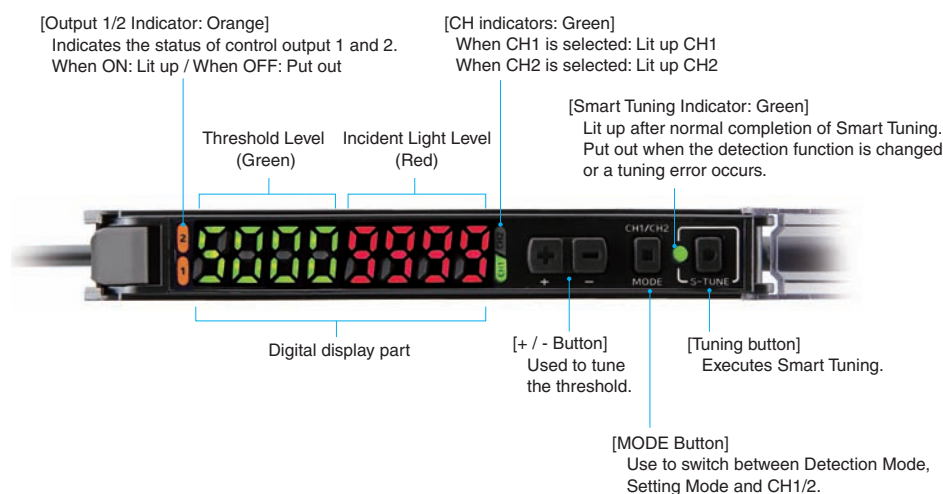

Safety Precautions

Be sure to read the precautions for all models in the website at: <http://www.ia.omron.com/>.

Warning Indications

 WARNING	Warning level Indicates a potentially hazardous situation which, if not avoided, will result in minor or moderate injury, or may result in serious injury or death. Additionally there may be significant property damage.
Precautions for Safe Use	Supplementary comments on what to do or avoid doing, to use the product safely.
Precautions for Correct Use	Supplementary comments on what to do or avoid doing, to prevent failure to operate, malfunction or undesirable effect on product performance.



⚠ WARNING

This product is not designed or rated for ensuring safety of persons either directly or indirectly. Do not use it for such purposes. 

Do not use it exceeding the rated voltage. There is a possibility of failure and fire. 

Never use the product with an AC power supply. Otherwise, explosion may result. 

Meaning of Product Safety Symbols

	General prohibition Instructions on unspecified prohibited action.
	Caution, fire Indicates the possibility of fires under specific conditions.
	Caution, explosion Indicates the possibility of explosion under specific conditions

Precautions for Safe Use

The following precautions must be observed to ensure safe operation of the Amplifier Unit. Doing so may cause damage or fire.

1. Do not install the product in the following locations.
 - Locations subject to direct sunlight
 - Locations subject to condensation due to high humidity
 - Locations to corrosive, flammable or explosive gases
 - Locations subject to vibration or mechanical shocks exceeding the rated values
 - Locations subject to exposure to water, oil, chemicals
 - Locations subject to stream
 - Locations subjected to strong magnetic field or electric field
 - In water, rainfall or outdoors
 - Any atmosphere or environment that exceeds the ratings
2. To secure the safety of operation and maintenance, do not install the product close to high-voltage devices and power devices.
3. High-voltage lines and power lines must be wired separately from the product. Wiring them together or placing them in the same duct may cause induction, resulting in malfunction or damage.
4. Please apply the load under rating and connect the load correctly. Do not short the load.
5. Do not use the product if the case is damaged.
6. Burn injury may occur. The product surface temperature rises depending on application conditions, such as the ambient temperature and the power supply voltage. Attention must be paid during operation or cleaning.
7. When setting the sensor, be sure to check safety such as by stopping the equipment.
8. Be sure to turn off the power supply before connecting or disconnecting wires.
9. Do not attempt to disassemble, repair, or modify the product in any way.
10. When disposing of the product, treat it as industrial waste.
11. Do not remove the cover on the side of the case. Otherwise, electric shock or malfunction may result.
12. If you notice any abnormal condition, immediately stop using the product, turn off the power and consult your dealer without doing any operation such as initialization.
13. When using a connector type product, place a protective label (provided with the E3X-CN series) on the power supply connecting terminals that are not used, to prevent electric shock or short circuit.

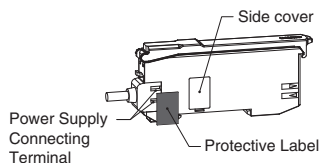

Precautions for Correct Use

1. Be sure to mount the unit to the DIN track and the connector until it clicks.
 2. The length for the cable extension must be 30 m or less. Be sure to use a cable of at least 0.3 mm² for extension.
 3. The power voltage must be 24 V when connecting amplifier units with extension cable and wire-saving connector.
 4. Do not apply the forces on the cord exceeding the limits. Do not use the cord while it is pinched or pressed.
Pull: 40 N; torque: 0.1 N·m; pressure: 20 N max; bending: 29.4 N
 5. Do not apply excessive force such as tension, compression or torsion to the amplifier unit with the fiber unit fixed to the amplifier unit.
 6. Please be aware of the polarity of the power supply to avoid miswiring. If there are input/output lines that are not used, insulate them.
 7. The product is ready to operate 250 ms after the power supply is turned ON.
 8. It may take time until the received light intensity become stable immediately after the power on.
 9. If the unit receives excessive light, the mutual interference prevention function may not work properly, resulting in malfunction of the unit. In such case, increase the threshold.
 10. Do not use the unit when EEPROM (non-volatile memory) exceeds its writing life (100,000 times). When you perform setting change, threshold change, tuning, zero reset and so on, the setting information is written.
 11. Use End Plates (PFP-M: separately sold) at the both ends of the grouped Amplifier Units to prevent them from separating due to vibration or other cause.
 12. Do not use alcohol, thinner, benzene, acetone, and lamp oil for cleaning.
 13. Please dispose the product  with on the case in accordance with relevant regulations (laws and regulations).
 14. The mutual interference prevention function does not work when in combination with series other than E3X-ZV/E3X-MZV series.
 15. The Communication Unit E3X-DRT21-S, E3X-CRT, E3X-ECT and E3NW cannot be connected.
 16. This product is not equipped with the Auto Power Control (APC) function.
 17. When being installed with amplifier tightly, connecting up to 16 wire-saving connector is allowed.
 18. The following notice applies only to products that carry the CE mark.
- Note:** In a residential environment, this product may cause radio interference, in which case the user may required to take adequate measures.

Dimensions

Fiber Amplifier Units

Pre-wired Amplifier Units

- E3X-ZV11
- E3X-ZV21
- E3X-ZV41
- E3X-ZV51



- *1. The Mounting Bracket can also be used on side B.
- *2. Cable Specifications

Model	Outer diameter	No. of conductors	Others
E3X-ZV11 E3X-ZV41	4.0 dia.	3	Conductor cross-section: 0.12 mm ² Insulator dia.: 0.9 mm Standard cable length: 2 m Minimum bending radius: 12 mm (Reference value)
E3X-ZV21 E3X-ZV51	4.0 dia.	4	Conductor cross-section: 0.14 mm ² Insulator dia.: 0.85 mm Standard cable length: 2 m Minimum bending radius: 12 mm (Reference value)

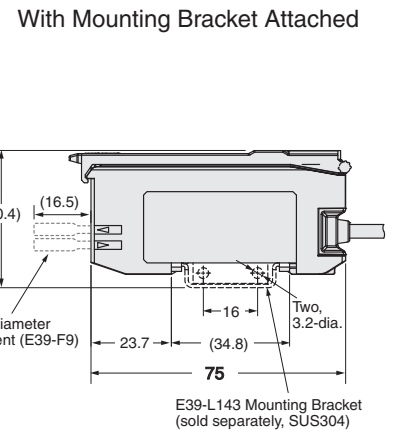
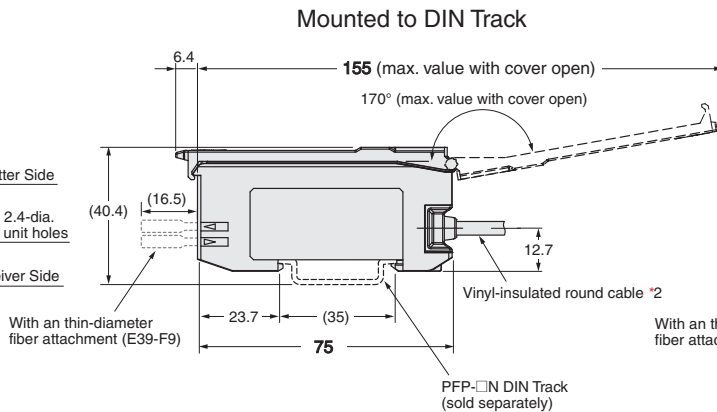
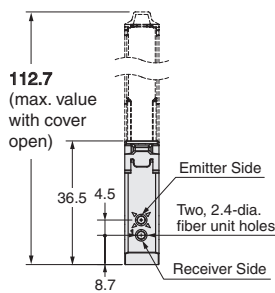
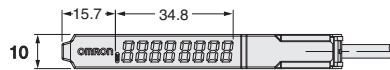

Mounting Holes

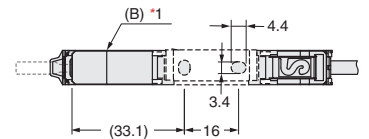
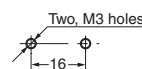

E3X-ZV / MZV

E3X-MZV11
E3X-MZV21
E3X-MZV41
E3X-MZV51



*1. The Mounting Bracket can also be used on side B.
*2. Cable Specifications

Model	Outer diameter	No. of conductors	Others
E3X-MZV11 E3X-MZV41	4.0 dia.	4	Conductor cross-section: 0.22 mm ²
			Insulator dia.: 0.9 mm
E3X-MZV21 E3X-MZV51	4.0 dia.	6	Standard cable length: 2 m
			Minimum bending radius: 12 mm (Reference value)
			Conductor cross-section: 0.12 mm ²
			Insulator dia.: 0.9 mm
			Standard cable length: 2 m
			Minimum bending radius: 12 mm (Reference value)

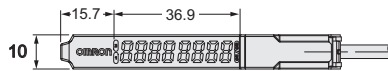

Mounted to DIN Track

With Mounting Bracket Attached

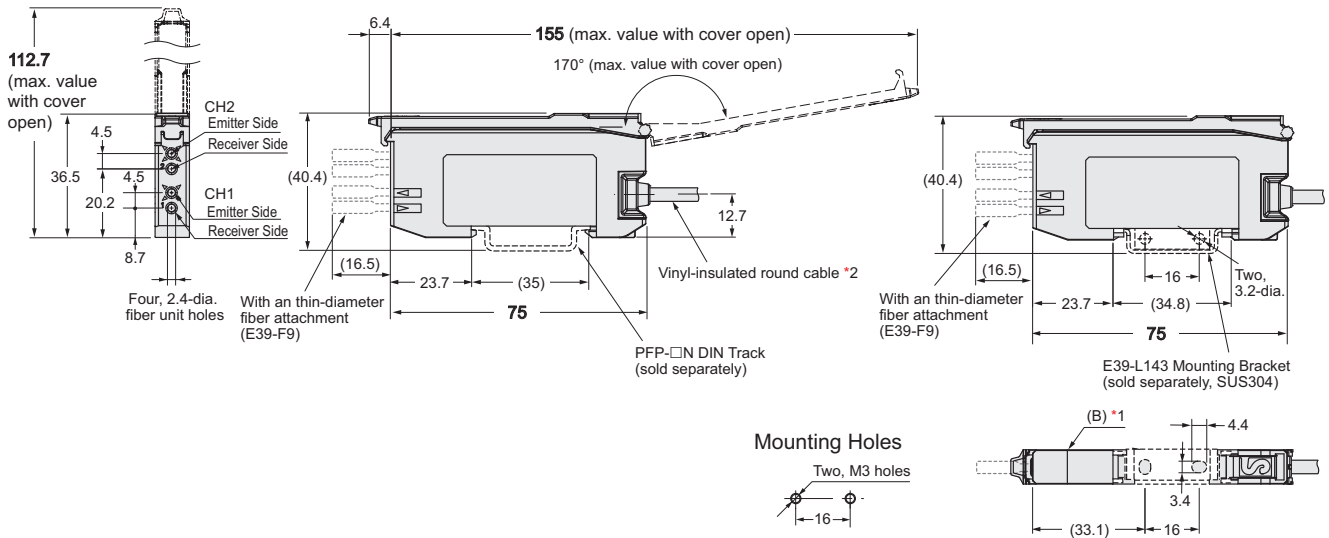

Wire-saving Connectors Units

- E3X-ZV6 E3X-ZV8
- E3X-ZV6M E3X-ZV8M
- E3X-ZV7 E3X-ZV9

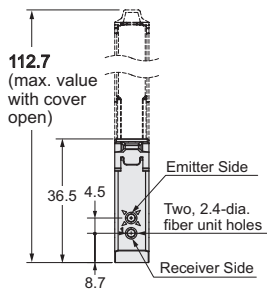
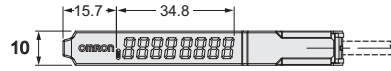

Mounted to DIN Track

With Mounting Bracket Attached

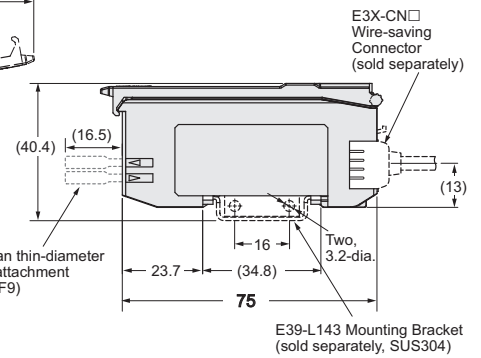
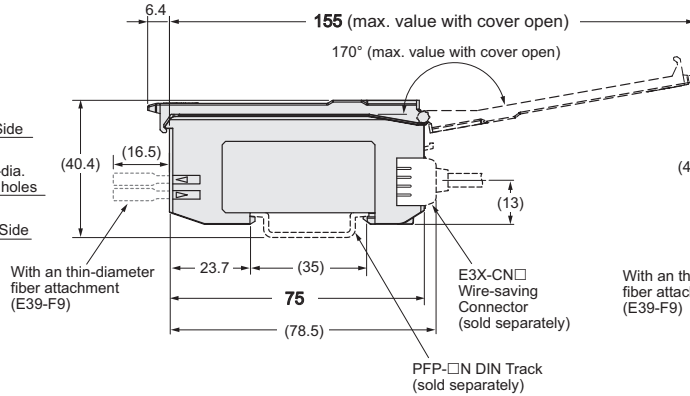

Mounting Holes

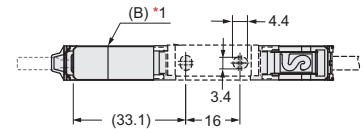
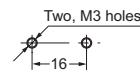

*1. The Mounting Bracket can also be used on side B.

E3X-MZV6
E3X-MZV8

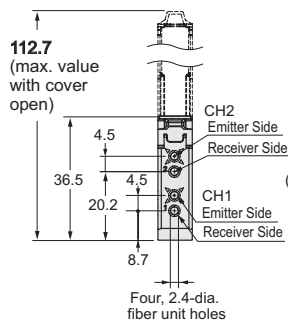
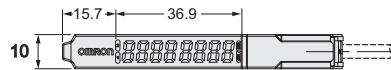

Mounted to DIN Track

With Mounting Bracket Attached

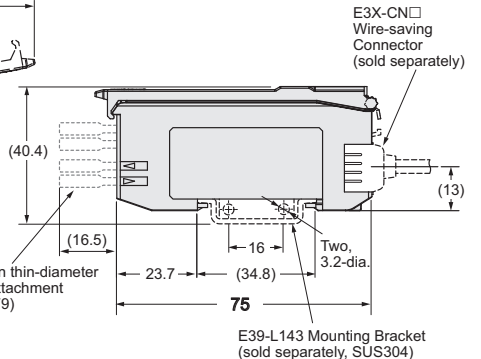
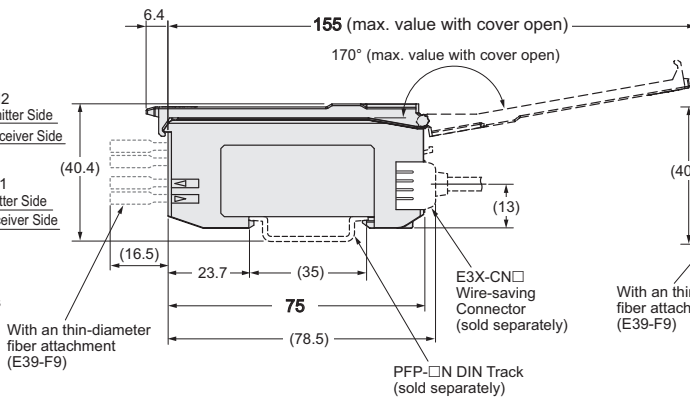

Mounting Holes

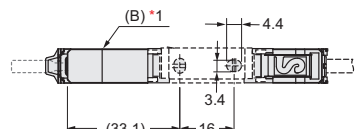
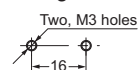

*1. The Mounting Bracket can also be used on side B.

Accessories (Sold Separately)

Wire-saving Connectors

Master Connector

E3X-CN11
E3X-CN21

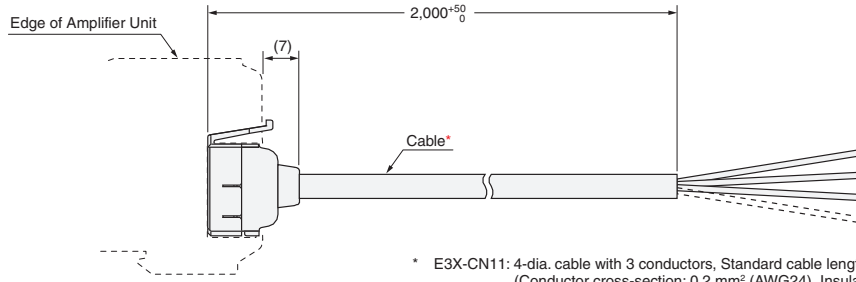

* E3X-CN11: 4-dia. cable with 3 conductors, Standard cable length: 2 m
(Conductor cross-section: 0.2 mm² (AWG24), Insulator diameter: 1.1 mm)
E3X-CN21: 4-dia. cable with 4 conductors, Standard cable length: 2 m
(Conductor cross-section: 0.2 mm² (AWG24), Insulator diameter: 1.1 mm)

Slave Connector

E3X-CN12
E3X-CN22

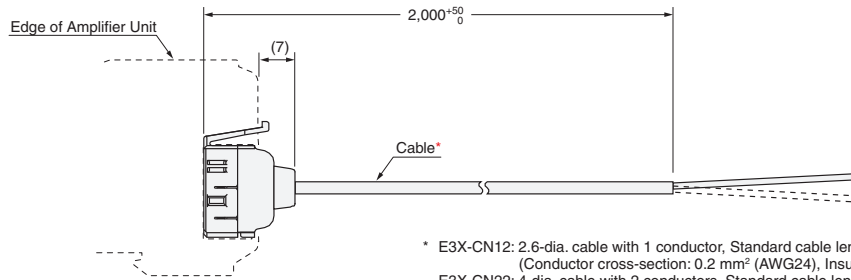

* E3X-CN12: 2.6-dia. cable with 1 conductor, Standard cable length: 2 m
(Conductor cross-section: 0.2 mm² (AWG24), Insulator diameter: 1.1 mm)
E3X-CN22: 4-dia. cable with 2 conductors, Standard cable length: 2 m
(Conductor cross-section: 0.2 mm² (AWG24), Insulator diameter: 1.1 mm)

DIN Track

PFP-100N
PFP-50N

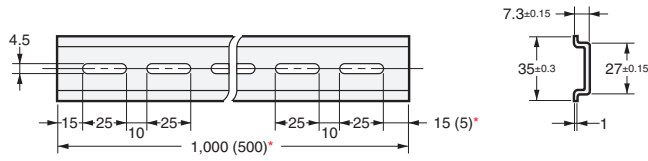

* Dimensions in parentheses are for the PFP-50N.

Material: Aluminum

Mounting Bracket

E39-L143

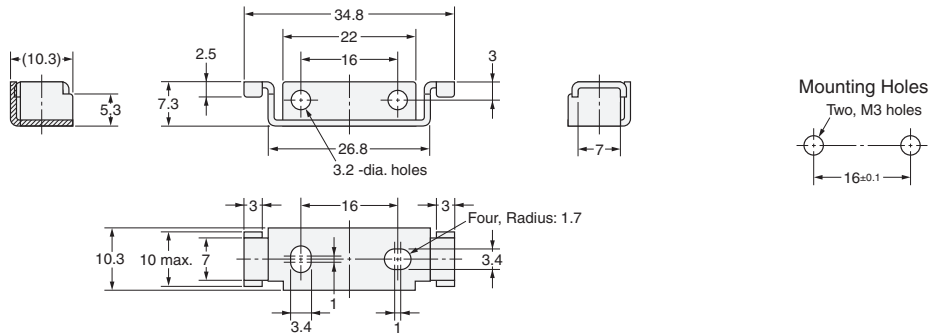
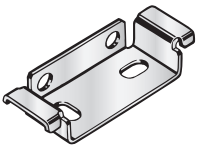

Material: Stainless steel (SUS304)

End Plate

PFP-M

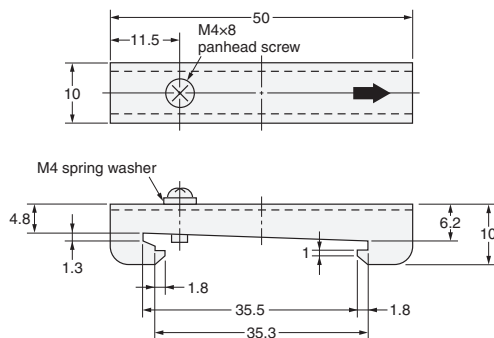
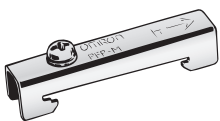

Materials: Iron, zinc plating

Terms and Conditions Agreement

Read and understand this catalog.

Please read and understand this catalog before purchasing the products. Please consult your OMRON representative if you have any questions or comments.

Warranties.

- (a) Exclusive Warranty. Omron's exclusive warranty is that the Products will be free from defects in materials and workmanship for a period of twelve months from the date of sale by Omron (or such other period expressed in writing by Omron). Omron disclaims all other warranties, express or implied.
- (b) Limitations. OMRON MAKES NO WARRANTY OR REPRESENTATION, EXPRESS OR IMPLIED, ABOUT NON-INFRINGEMENT, MERCHANTABILITY OR FITNESS FOR A PARTICULAR PURPOSE OF THE PRODUCTS. BUYER ACKNOWLEDGES THAT IT ALONE HAS DETERMINED THAT THE PRODUCTS WILL SUITABLY MEET THE REQUIREMENTS OF THEIR INTENDED USE.

Omron further disclaims all warranties and responsibility of any type for claims or expenses based on infringement by the Products or otherwise of any intellectual property right. (c) Buyer Remedy. Omron's sole obligation hereunder shall be, at Omron's election, to (i) replace (in the form originally shipped with Buyer responsible for labor charges for removal or replacement thereof) the non-complying Product, (ii) repair the non-complying Product, or (iii) repay or credit Buyer an amount equal to the purchase price of the non-complying Product; provided that in no event shall Omron be responsible for warranty, repair, indemnity or any other claims or expenses regarding the Products unless Omron's analysis confirms that the Products were properly handled, stored, installed and maintained and not subject to contamination, abuse, misuse or inappropriate modification. Return of any Products by Buyer must be approved in writing by Omron before shipment. Omron Companies shall not be liable for the suitability or unsuitability or the results from the use of Products in combination with any electrical or electronic components, circuits, system assemblies or any other materials or substances or environments. Any advice, recommendations or information given orally or in writing, are not to be construed as an amendment or addition to the above warranty.

See <http://www.omron.com/global/> or contact your Omron representative for published information.

Limitation on Liability; Etc.

OMRON COMPANIES SHALL NOT BE LIABLE FOR SPECIAL, INDIRECT, INCIDENTAL, OR CONSEQUENTIAL DAMAGES, LOSS OF PROFITS OR PRODUCTION OR COMMERCIAL LOSS IN ANY WAY CONNECTED WITH THE PRODUCTS, WHETHER SUCH CLAIM IS BASED IN CONTRACT, WARRANTY, NEGLIGENCE OR STRICT LIABILITY.

Further, in no event shall liability of Omron Companies exceed the individual price of the Product on which liability is asserted.

Suitability of Use.

Omron Companies shall not be responsible for conformity with any standards, codes or regulations which apply to the combination of the Product in the Buyer's application or use of the Product. At Buyer's request, Omron will provide applicable third party certification documents identifying ratings and limitations of use which apply to the Product. This information by itself is not sufficient for a complete determination of the suitability of the Product in combination with the end product, machine, system, or other application or use. Buyer shall be solely responsible for determining appropriateness of the particular Product with respect to Buyer's application, product or system. Buyer shall take application responsibility in all cases.

NEVER USE THE PRODUCT FOR AN APPLICATION INVOLVING SERIOUS RISK TO LIFE OR PROPERTY OR IN LARGE QUANTITIES WITHOUT ENSURING THAT THE SYSTEM AS A WHOLE HAS BEEN DESIGNED TO ADDRESS THE RISKS, AND THAT THE OMRON PRODUCT(S) IS PROPERLY RATED AND INSTALLED FOR THE INTENDED USE WITHIN THE OVERALL EQUIPMENT OR SYSTEM.

Programmable Products.

Omron Companies shall not be responsible for the user's programming of a programmable Product, or any consequence thereof.

Performance Data.

Data presented in Omron Company websites, catalogs and other materials is provided as a guide for the user in determining suitability and does not constitute a warranty. It may represent the result of Omron's test conditions, and the user must correlate it to actual application requirements. Actual performance is subject to the Omron's Warranty and Limitations of Liability.

Change in Specifications.

Product specifications and accessories may be changed at any time based on improvements and other reasons. It is our practice to change part numbers when published ratings or features are changed, or when significant construction changes are made. However, some specifications of the Product may be changed without any notice. When in doubt, special part numbers may be assigned to fix or establish key specifications for your application. Please consult with your Omron's representative at any time to confirm actual specifications of purchased Product.

Errors and Omissions.

Information presented by Omron Companies has been checked and is believed to be accurate; however, no responsibility is assumed for clerical, typographical or proofreading errors or omissions.

Fiber Sensor Best Selection Catalog

Refer to the Fiber Sensor Best Selection Catalog for information Fiber Units.

Cat.No.E418

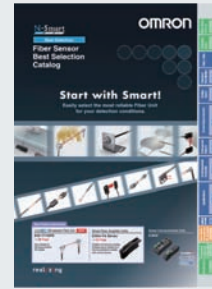

Note: Do not use this document to operate the Unit.

OMRON AUTOMATION AMERICAS HEADQUARTERS • Chicago, IL USA • 847.843.7900 • 800.556.6766 • automation.omron.com

OMRON CANADA, INC. • HEAD OFFICE

Toronto, ON, Canada • 416.286.6465 • 866.986.6766 • automation.omron.com

OMRON MEXICO • HEAD OFFICE

Ciudad de México • 52.55.5901.4300 • 01.800.386.6766 • mela@omron.com

OMRON ELETRÔNICA DO BRASIL LTDA • HEAD OFFICE

São Paulo, SP, Brasil • 55 11 5171-8920 • automation.omron.com

OMRON ARGENTINA • SALES OFFICE

Buenos Aires, Argentina • +54.11.4521.8630 • +54.11.4523.8483
mela@omron.com

OTHER OMRON LATIN AMERICA SALES

+54.11.4521.8630 • +54.11.4523.8483 • mela@omron.com