

# Product datasheet

Specifications



## Motor circuit breaker, TeSys GV4, 3P, 12.5A, Icu 50kA, magnetic, EverLink terminals

GV4L12N

### Main

Range	TeSys Deca
Range of product	TeSys GV4
Device short name	GV4L
Product name	TeSys GV4
Product or component type	Motor circuit breaker
Device application	Motor protection
Trip unit technology	Magnetic Electronic

### Complementary

Poles description	3P
Utilisation category	Category A conforming to IEC 60947-2 AC-3 conforming to IEC 60947-4-1
Operating position	Any position
Motor power kW	3 kW at 400...415 V AC 50/60 Hz 3 kW at 500 V AC 50/60 Hz 4 kW at 500 V AC 50/60 Hz 5.5 kW at 660...690 V AC 50/60 Hz 7.5 kW at 660...690 V AC 50/60 Hz 4 kW at 400...415 V AC 50/60 Hz 5.5 kW at 400...415 V AC 50/60 Hz 5.5 kW at 500 V AC 50/60 Hz 7.5 kW at 500 V AC 50/60 Hz 9 kW at 660...690 V AC 50/60 Hz 11 kW at 660...690 V AC 50/60 Hz
Breaking capacity	100 kA Icu at 220...240 V AC 50/60 Hz conforming to IEC 60947-2 50 kA Icu at 380...415 V AC 50/60 Hz conforming to IEC 60947-2 50 kA Icu at 440 V AC 50/60 Hz conforming to IEC 60947-2 15 kA Icu at 525 V AC 50/60 Hz conforming to IEC 60947-2 8 kA Icu at 660...690 V AC 50/60 Hz conforming to IEC 60947-2 25 kA Icu at 500 V AC 50/60 Hz conforming to IEC 60947-2
Control type	Rotary handle
[In] rated current	12.5 A
Magnetic tripping current	75...175 A
[Ue] rated operational voltage	690 V AC 50/60 Hz conforming to IEC 60947-2
[Ui] rated insulation voltage	800 V AC 50/60 Hz conforming to IEC 60947-2
[Ith] conventional free air thermal current	115 A conforming to IEC 60947-4-1
[Uimp] rated impulse withstand voltage	8 kV conforming to IEC 60947-2
Power dissipation per pole	6.1 W
Mechanical durability	40000 cycles

Excluding VAT and subject to change. Please check with your local distributor through "Where to buy"

<b>Electrical durability</b>	40000 cycles for AC-3 at 440 V In/2 40000 cycles for AC-3 at 440 V In
<b>maximum operating rate</b>	25 cyc/h
<b>Rated duty</b>	Continuous conforming to IEC 60947-4-1
<b>Connections - terminals</b>	EverLink BTR screw connectors (top) 1 cable(s) 1.5...70 mm <sup>2</sup> - solid EverLink BTR screw connectors (top) 1 cable(s) 1.5...50 mm <sup>2</sup> - flexible EverLink BTR screw connectors (bottom) 1 cable(s) 2.5...95 mm <sup>2</sup> - solid EverLink BTR screw connectors (bottom) 1 cable(s) 2.5...70 mm <sup>2</sup> - flexible
<b>Tightening torque</b>	9 N.m for cable 16...95 mm <sup>2</sup> 5 N.m for cable 1.5...10 mm <sup>2</sup>
<b>Mechanical robustness</b>	Vibrations: +/- 1 mm 2...13.2 Hz conforming to IEC 60068-2-6 Vibrations: 0.7 gn 13.2...100 Hz conforming to IEC 60068-2-6 Shocks: 15 gn 11 ms conforming to IEC 60068-2-27
<b>Height</b>	155 mm
<b>Width</b>	81 mm
<b>Depth</b>	165 mm
<b>Net weight</b>	1.65 kg
<b>Colour</b>	Grey (RAL 7016)
<b>Suitability for isolation</b>	Yes conforming to IEC 60947-1

## Environment

<b>Standards</b>	EN/IEC 60947-4-1 EN/IEC 60947-2
<b>Product certifications</b>	IEC CCC EAC EU-RO MR
<b>Climatic withstand</b>	conforming to IACS E10
<b>IK degree of protection</b>	IK07 conforming to IEC 62262
<b>Pollution degree</b>	3
<b>IP degree of protection</b>	IP40 conforming to IEC 60529
<b>Ambient air temperature for storage</b>	-50...85 °C
<b>Fire resistance</b>	960 °C conforming to IEC 60695-2-11
<b>Operating altitude</b>	5000 m
<b>Ambient air temperature for operation</b>	-25...70 °C

## Packing Units

<b>Unit Type of Package 1</b>	PCE
<b>Number of Units in Package 1</b>	1
<b>Package 1 Height</b>	10.900 cm
<b>Package 1 Width</b>	21.300 cm
<b>Package 1 Length</b>	22.100 cm
<b>Package 1 Weight</b>	1.826 kg
<b>Unit Type of Package 2</b>	S03
<b>Number of Units in Package 2</b>	3
<b>Package 2 Height</b>	30.000 cm

---

Package 2 Width	30.000 cm
Package 2 Length	40.000 cm
Package 2 Weight	9.500 kg

---

## Contractual warranty

---

Warranty (in months)	18
----------------------	----



## Environmental Data

Schneider Electric aims to achieve Net Zero status by 2050 through supply chain partnerships, lower impact materials, and circularity via our ongoing “Use Better, Use Longer, Use Again” campaign to extend product lifetimes and recyclability.

[Environmental Data explained >](#)

[How we assess product sustainability >](#)



### Environmental footprint

Total lifecycle Carbon footprint	114 kg CO2 eq.
Environmental Disclosure	<a href="#">Product Environmental Profile</a>
Carbon footprint of the manufacturing phase [A1 to A3]	11 kg CO2 eq.
Carbon footprint of the distribution phase [A4]	0.4 kg CO2 eq.
Carbon footprint of the installation phase [A5]	0.4 kg CO2 eq.
Carbon footprint of the use phase [B2, B3, B4, B6]	99 kg CO2 eq.
Carbon footprint of the end-of-life phase [C1 to C4]	4 kg CO2 eq.

### Use Better



### Materials and Substances

Packaging made with recycled cardboard	Yes
Packaging without single use plastic	Yes
<a href="#">EU RoHS Directive</a>	Compliant
SCIP Number	1b259a2c-3a3c-401a-acdd-f0837efd4018
REACH Regulation	<a href="#">REACH Declaration</a>
Halogen-free status	Halogen free plastic parts product
PVC free	Yes

### Use Longer



### Lifetime extension

Repair	No
--------	----

### Use Again



### Repack and remanufacture

Recyclability potential, in %	49
End of life manual availability	<a href="#">End of Life Information</a>
Take-back	No
WEEE Label	 The product must be disposed on European Union markets following specific waste collection and never end up in rubbish bins

Performance Curves

**Tripping Curves for GV4L and GV4LE Combined with Thermal Overload Relay LRD or LR9**

**Average Operating Times at 20 °C Related to Multiples of the Setting Current**

GV4L02 and GV4LE02 to 12 with LRD05 to LRD14, GV4L80 and GV4LE80 with LRD3363

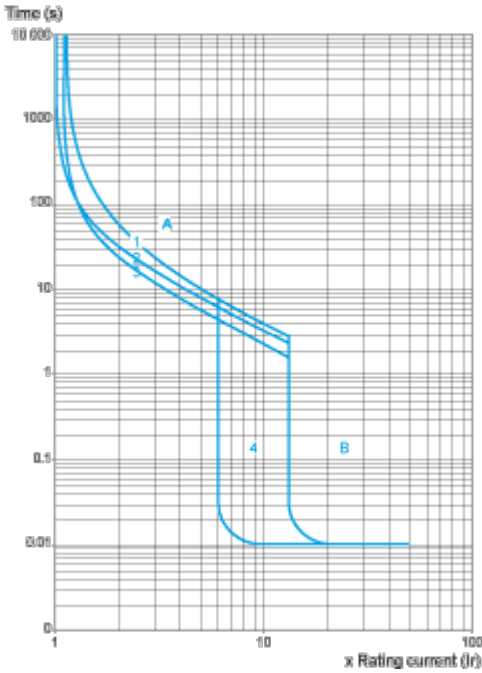

- 1 3 poles from cold state
- 2 2 poles from cold state
- 3 3 poles from hot state
- 4 6...14 Ir
- A Thermal overload relay protection zone
- B GV4L protection zone

GV4L25 and GV4LE25 with LRD 318, LRD325 GV4L50 AND GV4LE50 with LRD 332, LRD 340, LRD 350

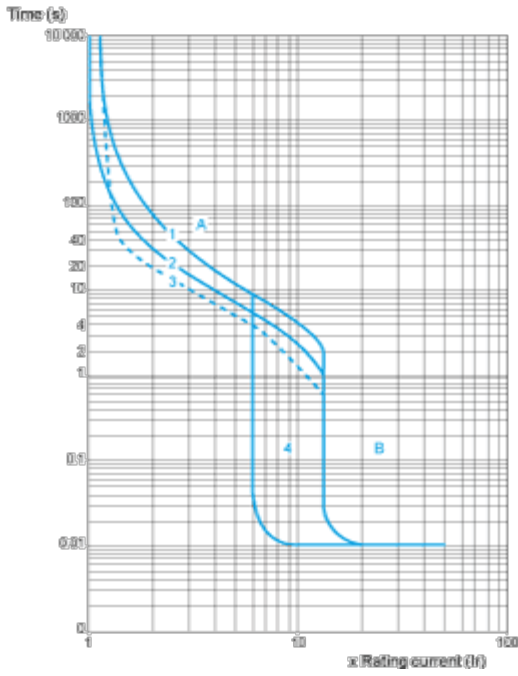

- 1 3 poles from cold state
- 2 2 poles from cold state
- 3 3 poles from hot state
- 4 6...14 Ir
- A Thermal overload relay protection zone
- B GV4L protection zone

GV4L115 and GV4LE115 with Class 10 LR9F5367, LR9D5369 and Class 20 LR9D5567, LR9F5569

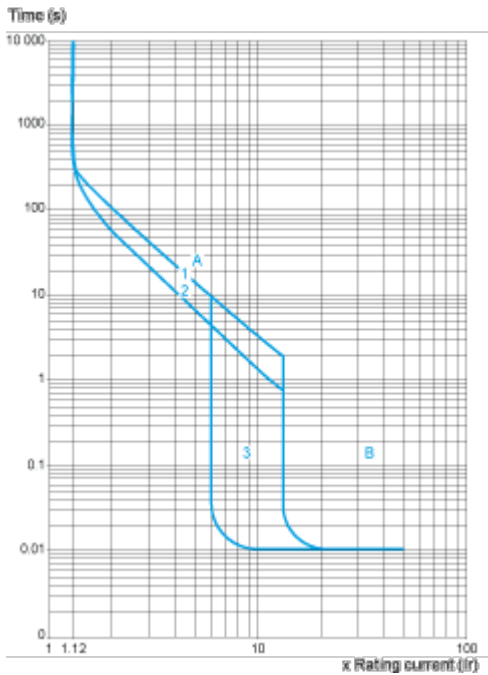

- 1 Cold state curve
- 2 Hot state curve
- 3 6...14 Ir

**Current Limitation on Short-Circuit for GV4L, GV4LE (3-Phase 400/415 V)**

**Dynamic Stress**

$I_{peak} = f(\text{prospective } I_{sc}) \text{ at } 1.05 U_e = 435 \text{ V}$



- 1 Maximum peak current
- 2 GV4L115
- 3 GV4L80
- 4 GV4L50
- 5 GV4L25
- 6 GV4L12
- 7 GV4L07
- 8 GV4L03
- 9 GV4L02

**Current Limitation on Short-Circuit for GV4L, GV4LE + Thermal Overload Relay LRD or LR9**

**(3-Phase 400/415 V)**

**Dynamic Stress**

$I_{peak} = f(\text{prospective } I_{sc}) \text{ at } 1.05 U_e = 435 \text{ V}$



- 1 Maximum peak current
- 2 GV4L115 + LR9D5367 or LR9F5367
- 3 GV4L80 + LRD3361
- 4 GV4L50 + LRD340
- 5 GV4L25 + LRD325
- 6 GV4L12 + LRD313
- 7 GV4L07 + LRD12
- 8 GV4L03 + LRD07
- 9 GV4L02 + LRD07

**Thermal Limit on Short-Circuit for GV4L, GV4LE**

Thermal Limit in A<sup>2</sup>s

Sum of I<sup>2</sup>dt = f (prospective Isc) at 1.05 Ue = 435 V



- 1 GV4L115
- 2 GV4L80
- 3 GV4L50
- 4 GV4L25
- 5 GV4L12
- 6 GV4L07
- 7 GV4L03
- 8 GV4L02

**Current Limitation on Short-Circuit for GV4L, GV4LE + Thermal Overload Relay LRD or LR9**

Thermal Limit in kA in the Magnetic Operating Zone

Sum of  $I^2dt = f(\text{prospective } I_{sc})$  at  $1.05 U_e = 435 V$



- 1 GV4L115 + LR9D5367 or LR9F5367
- 2 GV4L80 + LRD3361
- 3 GV4L50 + LRD340
- 4 GV4L25 + LRD325
- 5 GV4L12 + LRD313
- 6 GV4L07+ LRD12
- 7 GV4L03+ LRD07
- 8 GV4L02 + LRD07

Dimensions Drawings

GV4 with Toggle: GV4LE, GV4PE, GV4PEM

With EverLink® Connector

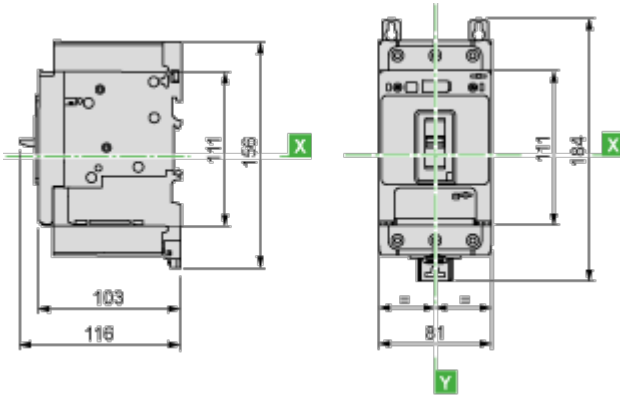

With Crimp Lug Connector

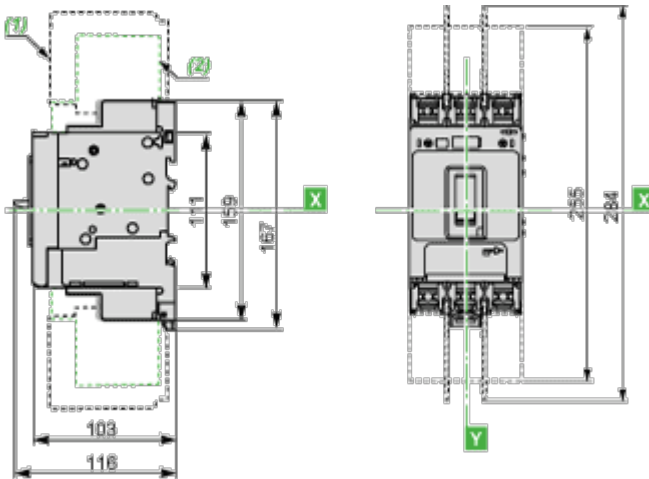

- (1) Interphases barriers
- (2) Long terminal shield

GV4 with Rotary Handle: GV4L, GV4P, or GV4LE, GV4PE, GV4PEM with GV4ADN01, GV4ADN02 Direct Mounting Rotary Handle

Dimensions

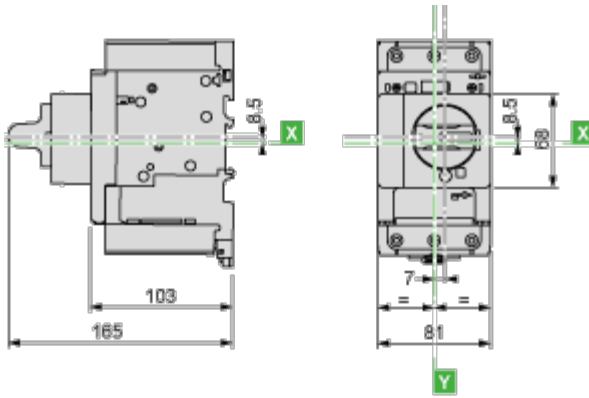

**GV4L, GV4P, GV4LE, GV4PE, GV4PEM**  
Panel Mounting with M4 Screws



**Door Cut-Out for Rotary Handle**

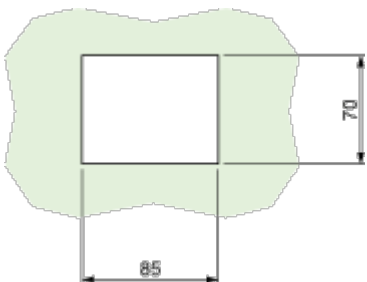

**Minimum Safety Clearance**

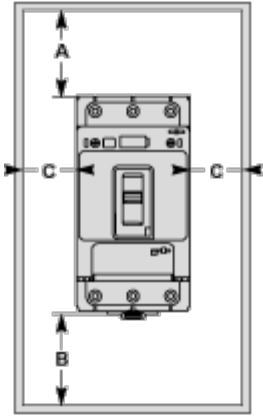

Toggle-type, rotary handle-type: identical clearance values.

	Safety Clearance (mm)					
	Painted Sheet Metal			Bare Sheet Metal		
	A	B	C	A	B	C
No accessory	30	0	0	40	0	5
Interphase barriers	0	0	0	0	0	5
Long terminal shield	0	0	0	0	0	5

Connections and Schema

---

Magnetic Motor Circuit Breakers  
GV4L, GV4LE



Offer Marketing Illustration

Product benefits / Features

---

## TeSys Deca Motor Circuit Breakers

### Technical Benefits



- Combines a circuit breaker and overload relay in a single device.
- Gives great detection accuracy, as well as alarming and advanced protections for refs.
- Magnetic, electronic thermal-magnetic, or electronic thermal magnetic versions with advanced protection.
- Patented EverLink creep-compensating technology.
- Spring-based system ensures a long lasting connection.
- Electronic core for high-accuracy, wide settings, dual motor class 10/20.

Offer Marketing Illustration

Product benefits / Features

---

## TeSys Deca Motor Circuit Breakers



### Increase safety

Featuring EverLink technology, double rotary contact system, and Reflex tripping mechanism to ensure your operations run smoothly and securely.



### Improve efficiency

With a compact design, hassle-free installation with one-click spring terminal accessories, while easy monitoring with visible auxiliaries.



### Save time

Simple to specify, install and use for all applications and easy access to facilitate maintenance on site.



Offer Marketing Illustration

Product benefits / Features

---



## TeSys Deca Motor Circuit Breakers

### Range Accessories



Auxiliary contact



Lug connector



Voltage release



Long terminal shield



Interphase barriers



Spreaders



Sealing accessories



Torque limiting breakaway bits