

Product data sheet

Characteristics

XSAV11373L05

inductive sensor XSAV - M30 - Sn10mm -
6..150c/mn - 12..48VDC - cable 5m

Product availability : Non-Stock - Not normally stocked in distribution facility



Price* : 179.28 USD



Main

Range of product	OsiSense XS
Series name	Application
Sensor type	Inductive proximity sensor
Device application	Rotation monitoring
Sensor name	XSA
Sensor design	Cylindrical M30
Size	81 mm
Body type	Fixed
Detector flush mounting acceptance	Flush mountable
Material	Metal
Enclosure material	Nickel plated brass
Type of output signal	Discrete
Wiring technique	3-wire
[Sn] nominal sensing distance	0.39 in (10 mm)
Discrete output function	1 NC
Output circuit type	DC
Discrete output type	PNP
Electrical connection	Cable
Cable length	16.4 ft (5 m)
[Us] rated supply voltage	12...48 V DC with reverse polarity protection
Switching capacity in mA	<= 200 mA with overload and short-circuit protection
IP degree of protection	IP67 conforming to IEC 60529

Complementary

Thread type	M30 x 1.5
Detection face	Frontal

Front material	PPS
Adjustable frequency range	6...150 cyc/mn
Operating zone	0...0.31 in (0...8 mm)
Differential travel	3...15% of Fr
Repeat accuracy	3% of Sr
Cable composition	3 x 0.34 mm ²
Wire insulation material	PvR
Status LED	1 LED red output state
Supply voltage limits	10...58 V DC
Switching frequency	<= 100 Hz
Voltage drop	<= 1.8 V at closed state
Current consumption	0...15 mAat no-load
Run-up delay at power-up	9 s standard
Marking	CE
Threaded length	2.24 in (57 mm)
Height	1.18 in (30 mm)
Length	3.19 in (81 mm)
Product weight	0.66 lb(US) (0.3 kg)

Environment

Product certifications	CCC CSA UL
Ambient air temperature for operation	-13...158 °F (-25...70 °C)

Ordering and shipping details

Category	22486 - SENSORS, PROXIMITY
Discount Schedule	DS2
GTIN	003389110658927
Nbr. of units in pkg.	1
Package weight(Lbs)	0.7399999999999999
Returnability	N
Country of origin	FR

Offer Sustainability

Sustainable offer status	Green Premium product
RoHS (date code: YYWW)	Compliant - since 0825 - Schneider Electric declaration of conformity Schneider Electric declaration of conformity
REACH	Reference not containing SVHC above the threshold Reference not containing SVHC above the threshold
Product environmental profile	Available
Product end of life instructions	Available
California proposition 65	WARNING: This product can expose you to chemicals including:
----- Substance 1	Diisononyl phthalate (DINP), which is known to the State of California to cause cancer, and
----- Substance 2	Di-isodecyl phthalate (DIDP), which is known to the State of California to cause birth defects or other reproductive harm.
----- More information	For more information go to www.p65warnings.ca.gov

Contractual warranty

Warranty period	18 months
-----------------	-----------

Dimensions

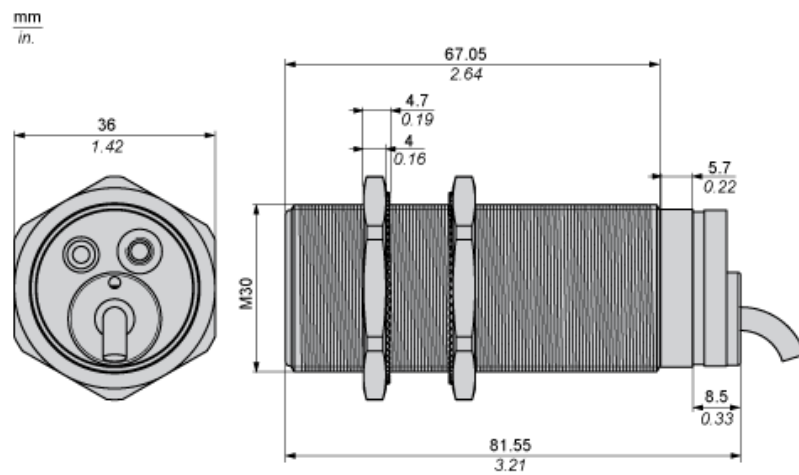

(1) LED

Minimum Mounting Distances

Side by side



$e (1) \geq 20 \text{ mm}/0.79 \text{ in}$

Face to face



$e (2) \geq 120 \text{ mm}/4.72 \text{ in}$

Facing a metal object



$e (3) \geq 30 \text{ mm}/1.18 \text{ in.}$

Wiring Schemes

3-wire DC

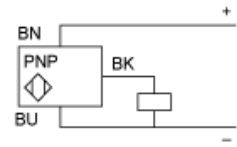

BU : Blue
BN : Brown
BK : Black

Performance Curves

Standard Steel Target : 30x30x1 mm

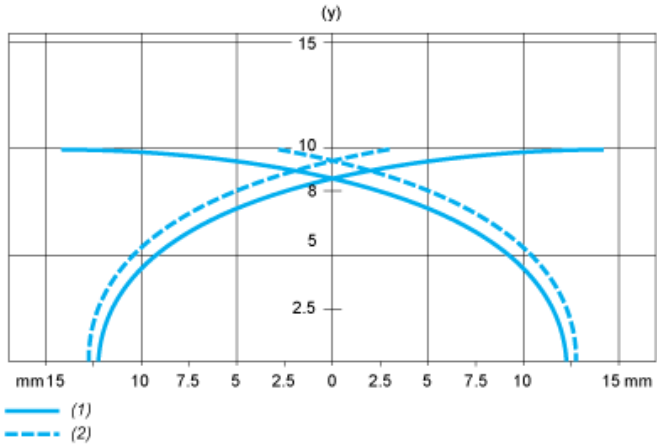

- (1) Pick-up points
- (2) Drop-out points (object approaching from the side)
- (y) Sensing distance in mm