

Product data sheet

Specifications



miniature plug in relay, Harmony Electromechanical Relays, 10A, 2CO, with LED, with lockable test button, 24V DC

RXM2CB2BD

! Discontinued

Main

Range of product	Harmony Electromechanical Relays
Series name	RXM series
Product or component type	Plug-in relay
Utilisation coefficient	20 %
Sale per indivisible quantity	10
[Uc] control circuit voltage	24 V DC

Complementary

Contacts type and composition	2 C/O
[Ithe] conventional enclosed thermal current	10 A at -40...55 °C
status LED	With
Control type	Lockable test button
[Ui] rated insulation voltage	250 V conforming to IEC 300 V conforming to UL
[Uimp] rated impulse withstand voltage	3.6 kV during 1.2/50 µs conforming to IEC 61810-7
Contacts material	Silver alloy (Ag/Ni)
[Ie] rated operational current	10 A (AC-1/DC-1) conforming to UL 10 A (AC-1/DC-1) NO conforming to IEC 5 A (AC-1/DC-1) NC conforming to IEC
minimum switching current	10 mA
Maximum switching voltage	250 V AC 125 V DC
Minimum switching voltage	17 V
Load current	10 A at 250 V AC 10 A at 30 V DC
Maximum switching capacity	2500 VA AC 300 W DC
Minimum switching capacity	170 mW
Operating rate	<= 1200 cycles/hour under load <= 18000 cycles/hour no-load
Mechanical durability	10000000 cycles
Electrical durability	100000 cycles for resistive load
Average coil consumption	1 W, DC
Drop-out voltage threshold	>= 0.1 U _c DC

Operating time	20 ms
Average resistance	630 Ohm network: DC at 20 °C +/- 10 %
Rated operational voltage limits	19.2...26.4 V DC
Protection category	RT I
Test levels	Level A group mounting
Operating position	Any position
CAD overall width	21 mm
CAD overall height	27 mm
CAD overall depth	55 mm
Net weight	0.037 kg
Dielectric strength	1800 V AC between coil and contact 1550 V AC between poles 1000 V AC between contacts
Safety reliability data	B10d = 100000
Shape of pin	Flat (faston type)

Environment

Product certifications	GOST UL
Standards	IEC 61810-1 UL 508
Ambient air temperature for storage	-40...70 °C
Ambient air temperature for operation	-40...55 °C
Vibration resistance	3 gn, amplitude = +/- 1 mm (f = 10...55 Hz)without clip conforming to IEC 60068-2-6 5 gn, amplitude = +/- 1 mm (f = 10...55 Hz)with clip conforming to IEC 60068-2-6
IP degree of protection	IP40 conforming to IEC 60529
Shock resistance	10 gn (duration = 11 ms) for opening conforming to IEC 60068-2-27 10 gn (duration = 11 ms) for closing conforming to IEC 60068-2-27

Packing Units

Unit Type of Package 1	PCE
Number of Units in Package 1	1
Package 1 Height	2.1 cm
Package 1 Width	2.8 cm
Package 1 Length	4.8 cm
Package 1 Weight	40.0 g
Unit Type of Package 2	BB1
Number of Units in Package 2	10
Package 2 Height	2.9 cm
Package 2 Width	10.4 cm
Package 2 Length	13.1 cm
Package 2 Weight	371.0 g
Unit Type of Package 3	S02
Number of Units in Package 3	270

Package 3 Height	15.0 cm
Package 3 Width	30.0 cm
Package 3 Length	40.0 cm
Package 3 Weight	10.69 kg

Contractual warranty

Warranty (in months)	18
----------------------	----



Environmental Data

Schneider Electric aims to achieve Net Zero status by 2050 through supply chain partnerships, lower impact materials, and circularity via our ongoing “Use Better, Use Longer, Use Again” campaign to extend product lifetimes and recyclability.

[Environmental Data explained >](#)

[How we assess product sustainability >](#)



Environmental footprint

Total lifecycle Carbon footprint	15 kg CO2 eq.
Carbon footprint of the manufacturing phase [A1 to A3]	0.3 kg CO2 eq.
Carbon footprint of the distribution phase [A4]	0 kg CO2 eq.
Carbon footprint of the installation phase [A5]	0 kg CO2 eq.
Carbon footprint of the use phase [B2, B3, B4, B6]	15 kg CO2 eq.
Carbon footprint of the end-of-life phase [C1 to C4]	0 kg CO2 eq.
Environmental Disclosure	Product Environmental Profile

Use Better



Materials and Substances

Packaging made with recycled cardboard	Yes
Packaging without single use plastic	Yes
EU RoHS Directive	Compliant
REACH Regulation	Free of Substances of Very High Concern above the threshold

Use Longer



Lifetime extension

Repair	No
--------	----

Use Again



Repack and remanufacture

End of life manual availability	End of Life Information
Take-back	No

Dimensions Drawings

Dimensions

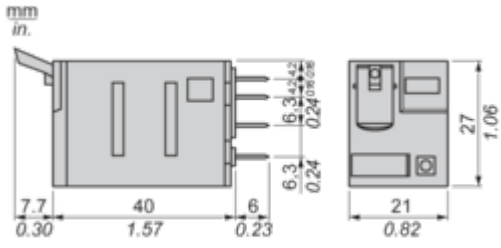

Pin Side View

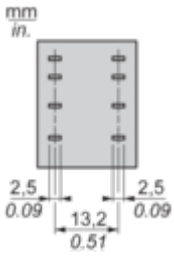

Connections and Schema

Wiring Diagram

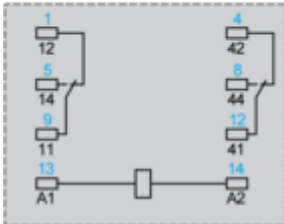
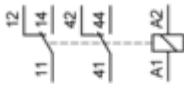

Symbols shown in blue correspond to Nema marking.

Performance Curves

Electrical Durability of Contacts

Resistive load

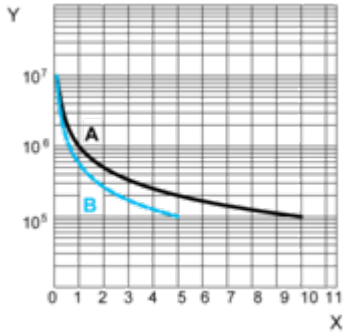

X : Contact current (A)
Y : Durability (Number of operating cycles)
A : RXM 2CB...
B : RXM 4CB...
Inductive load

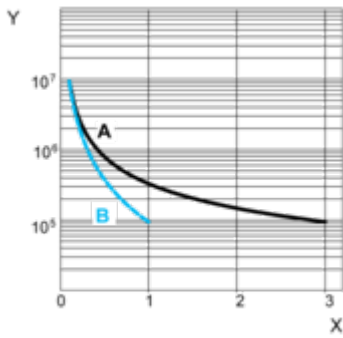

X : Contact current (A)
Y : Durability (Number of operating cycles)
A : RXM 2CB...
B : RXM 4CB...
Note : These are typical curves, actual durability depends on load, environment, duty cycle, etc.

Maximum Switching Capacity on Resistive and Inductive Loads

RXM 2CB...

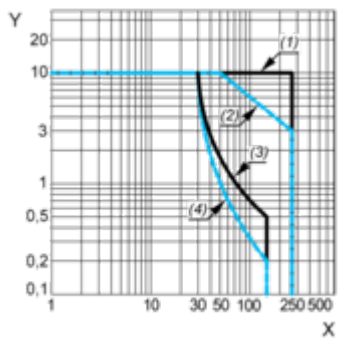

X : Switching Voltage (V)

Y : Switching current (A)

(1) AC resistive load

(2) AC inductive load (cos phi) = 0.4

(3) DC resistive load

(4) DC inductive load (T0.95 = 6 P)

Note : These are typical curves, actual durability depends on load, environment, duty cycle, etc.

Technical Illustration

Dimensions

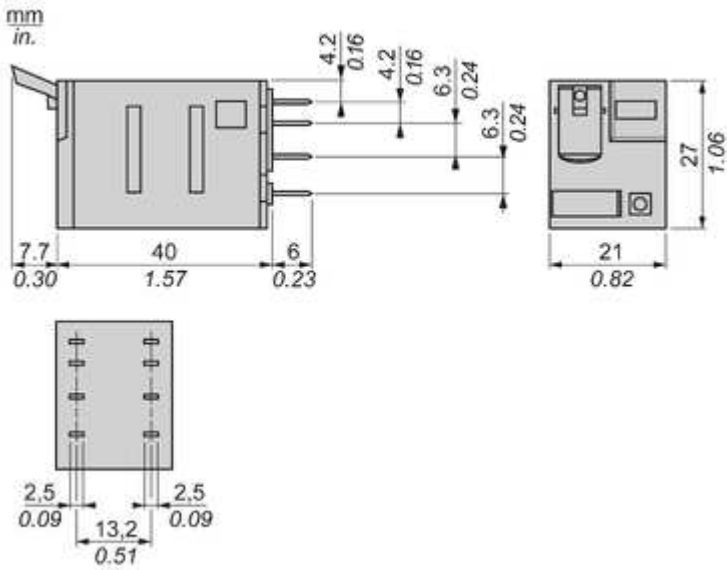

Image of product / Alternate images

Alternative



