



contactor relay railway, 2 NO + 1 NC, 110 V DC, 0.7-1.25*Us, with integrated suppressor diode, spring-loaded terminal, frame size S00

product brand name	SIRIUS
product designation	Contactor relay for railway applications
product type designation	3RH2
General technical data	
size of contactor	S00
product extension auxiliary switch	Yes
power loss [W] for rated value of the current without load current share typical	2.8 W
insulation voltage with degree of pollution 3 at AC rated value	690 V
surge voltage resistance rated value	6 kV
shock resistance at rectangular impulse	
• at DC	10 g / 5 ms, 5 g / 10 ms
shock resistance with sine pulse	
• at DC	15 g / 5 ms, 8 g / 10 ms
mechanical service life (operating cycles)	
• of contactor typical	30 000 000
• of the contactor with added electronically optimized auxiliary switch block typical	5 000 000
• of the contactor with added auxiliary switch block typical	10 000 000
reference code according to IEC 81346-2	K
Substance Prohibition (day/month/year)	10/01/2009
SVHC substance name	Lead CAS-No. 7439-92-1
Net Weight	0.322 kg
Ambient conditions	
installation altitude at height above sea level maximum	2 000 m
ambient temperature	
• during operation	-40 ... +70 °C
• during storage	-55 ... +80 °C
relative humidity minimum	10 %
relative humidity at 55 °C according to IEC 60068-2-30 maximum	95 %
Main circuit	
no-load switching frequency	
• at AC	10 000 1/h
• at DC	10 000 1/h
Control circuit/ Control	
type of voltage of the control supply voltage	DC
control supply voltage at DC rated value	110 V
operating range factor control supply voltage rated value of magnet coil at DC	

• initial value	0.7
• full-scale value	1.25
design of the surge suppressor	suppressor diode
closing power of magnet coil at DC	13 W
holding power of magnet coil at DC	4 W
closing delay	
• at DC	25 ... 130 ms
opening delay	
• at DC	7 ... 20 ms
arcing time	10 ... 15 ms
Auxiliary circuit	
number of NC contacts for auxiliary contacts	1
• instantaneous contact	1
number of NO contacts for auxiliary contacts	2
• instantaneous contact	2
identification number and letter for switching elements	21
operational current at AC-12 maximum	10 A
operational current at AC-15	
• at 230 V rated value	10 A
• at 400 V rated value	3 A
• at 500 V rated value	2 A
• at 690 V rated value	1 A
operational current at 1 current path at DC-12	
• at 24 V rated value	10 A
• at 110 V rated value	3 A
• at 220 V rated value	1 A
• at 440 V rated value	0.3 A
• at 600 V rated value	0.15 A
operational current with 2 current paths in series at DC-12	
• at 24 V rated value	10 A
• at 60 V rated value	10 A
• at 110 V rated value	4 A
• at 220 V rated value	2 A
• at 440 V rated value	1.3 A
• at 600 V rated value	0.65 A
operational current with 3 current paths in series at DC-12	
• at 24 V rated value	10 A
• at 60 V rated value	10 A
• at 110 V rated value	10 A
• at 220 V rated value	3.6 A
• at 440 V rated value	2.5 A
• at 600 V rated value	1.8 A
operating frequency at DC-12 maximum	1 000 1/h
operational current at 1 current path at DC-13	
• at 24 V rated value	10 A
• at 110 V rated value	1 A
• at 220 V rated value	0.3 A
• at 440 V rated value	0.14 A
• at 600 V rated value	0.1 A
operational current with 2 current paths in series at DC-13	
• at 24 V rated value	10 A
• at 60 V rated value	3.5 A
• at 110 V rated value	1.3 A
• at 220 V rated value	0.9 A
• at 440 V rated value	0.2 A
• at 600 V rated value	0.1 A
operational current with 3 current paths in series at DC-13	
• at 24 V rated value	10 A
• at 60 V rated value	4.7 A

<ul style="list-style-type: none"> • at 110 V rated value • at 220 V rated value • at 440 V rated value • at 600 V rated value 	3 A 1.2 A 0.5 A 0.26 A
operating frequency at DC-13 maximum	1 000 1/h
contact reliability of auxiliary contacts	1 faulty switching per 100 million (17 V, 1 mA)
UL/CSA ratings	
contact rating of auxiliary contacts according to UL	A600 / Q600
Short-circuit protection	
design of the miniature circuit breaker for short-circuit protection of the auxiliary circuit up to 230 V	C characteristic: 10 A; 0.4 kA
design of the fuse link for short-circuit protection of the auxiliary switch required	gG: 10 A (690 V, 1 kA)
Installation/ mounting/ dimensions	
mounting position	+/-180° rotation possible on vertical mounting surface; can be tilted forward and backward by +/- 22.5° on vertical mounting surface
fastening method side-by-side mounting	Yes
fastening method	screw and snap-on mounting onto 35 mm DIN rail
height	70 mm
width	45 mm
depth	116 mm
required spacing	
<ul style="list-style-type: none"> • with side-by-side mounting <ul style="list-style-type: none"> — forwards — upwards — downwards — at the side • for grounded parts <ul style="list-style-type: none"> — forwards — upwards — at the side — downwards • for live parts <ul style="list-style-type: none"> — forwards — upwards — downwards — at the side 	10 mm 10 mm 10 mm 0 mm 10 mm 10 mm 6 mm 10 mm 10 mm 10 mm 10 mm 6 mm
Connections/ Terminals	
type of electrical connection for auxiliary and control circuit	spring-loaded terminals
connectable conductor cross-section for auxiliary contacts	
<ul style="list-style-type: none"> • solid or stranded • finely stranded with core end processing • finely stranded without core end processing 	0.5 ... 4 mm ² 0.5 ... 2.5 mm ² 0.5 ... 2.5 mm ²
type of connectable conductor cross-sections	
<ul style="list-style-type: none"> • for auxiliary contacts <ul style="list-style-type: none"> — solid or stranded — finely stranded with core end processing — finely stranded without core end processing • for AWG cables for auxiliary contacts 	2x (0.5 ... 4 mm ²) 2x (0.5 ... 2.5 mm ²) 2x (0.5 ... 2.5 mm ²) 2x (20 ... 12)
AWG number as coded connectable conductor cross section for auxiliary contacts	20 ... 12
Safety related data	
product function positively driven operation according to IEC 60947-5-1	Yes
proportion of dangerous failures	
<ul style="list-style-type: none"> • with low demand rate according to SN 31920 • with high demand rate according to SN 31920 	40 % 73 %
B10 value with high demand rate according to SN 31920	1 000 000; With 0.3 x I _e
failure rate [FIT] with low demand rate according to SN 31920	100 FIT

IEC 61508	
T1 value	
<ul style="list-style-type: none"> for proof test interval or service life according to IEC 61508 	20 a

Electrical Safety	
protection class IP on the front according to IEC 60529	IP20
touch protection on the front according to IEC 60529	finger-safe, for vertical contact from the front

Approvals Certificates

Environmental Product Declaration	
<ul style="list-style-type: none"> global warming potential [CO2 eq] / during manufacturing global warming potential [CO2 eq] / during operation global warming potential [CO2 eq] / after end of life global warming potential [CO2 eq] / total 	1.3 kg 132 kg -0.227 kg 133 kg

Environment	General Product Approval
-------------	--------------------------

[Environmental Confirmations](#)









General Product Approval	EMV	Functional Safety
--------------------------	-----	-------------------









[Type Examination Certificate](#)

Test Certificates	Maritime application
-------------------	----------------------

[Special Test Certificate](#)
[Type Test Certificates/Test Report](#)





Maritime application	other
----------------------	-------



[Confirmation](#)
[Miscellaneous](#)

Railway	Dangerous goods
---------	-----------------

[Special Test Certificate](#)
[Transport Information](#)

Further information

Information on the packaging
<https://support.industry.siemens.com/cs/ww/en/view/109813875>
Information for data generation and storage
<https://support.industry.siemens.com/cs/ww/en/view/109995012>
Information- and Downloadcenter (Catalogs, Brochures,...)
<https://www.siemens.com/ic10>
Industry Mall (Online ordering system)
<https://mall.industry.siemens.com/mall/en/en/Catalog/product?mlfb=3RH2122-2KF40-0LA0>
Service&Support (Manuals, Certificates, Characteristics, FAQs,...)
<https://support.industry.siemens.com/cs/ww/en/ps/3RH2122-2KF40-0LA0>
Image database (product images, 2D dimension drawings, 3D models, device circuit diagrams, EPLAN macros, ...)
https://www.automation.siemens.com/bilddb/cax_de.aspx?mlfb=3RH2122-2KF40-0LA0&lang=en
Cax online generator
<https://support.automation.siemens.com/WW/CAXorder/default.aspx?lang=en&mlfb=3RH2122-2KF40-0LA0>

Characteristic curves

https://curves.siemens.com/curves/<mmp_prod_noCOMP='HAUPT'></mmp_prod_no>

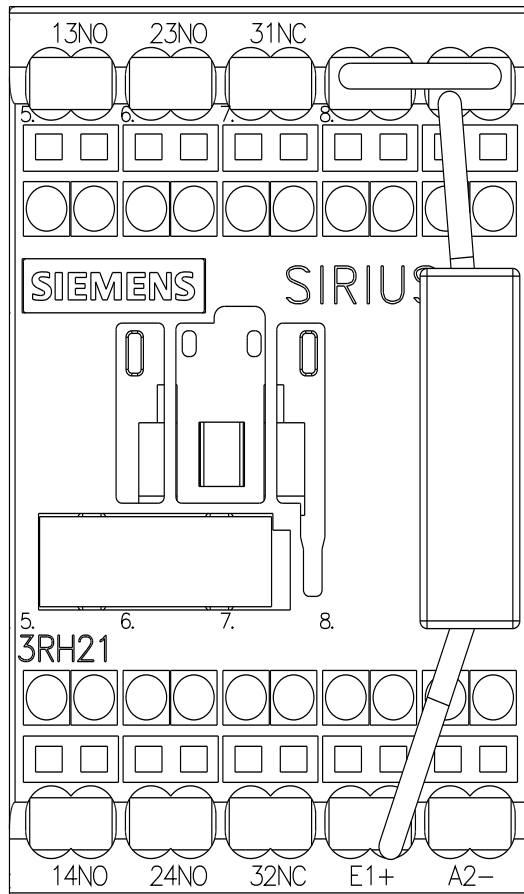
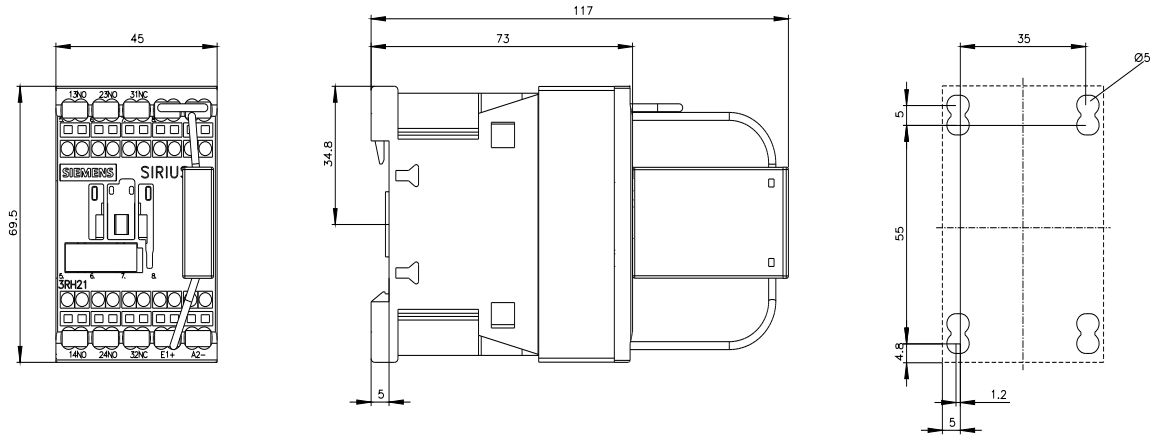

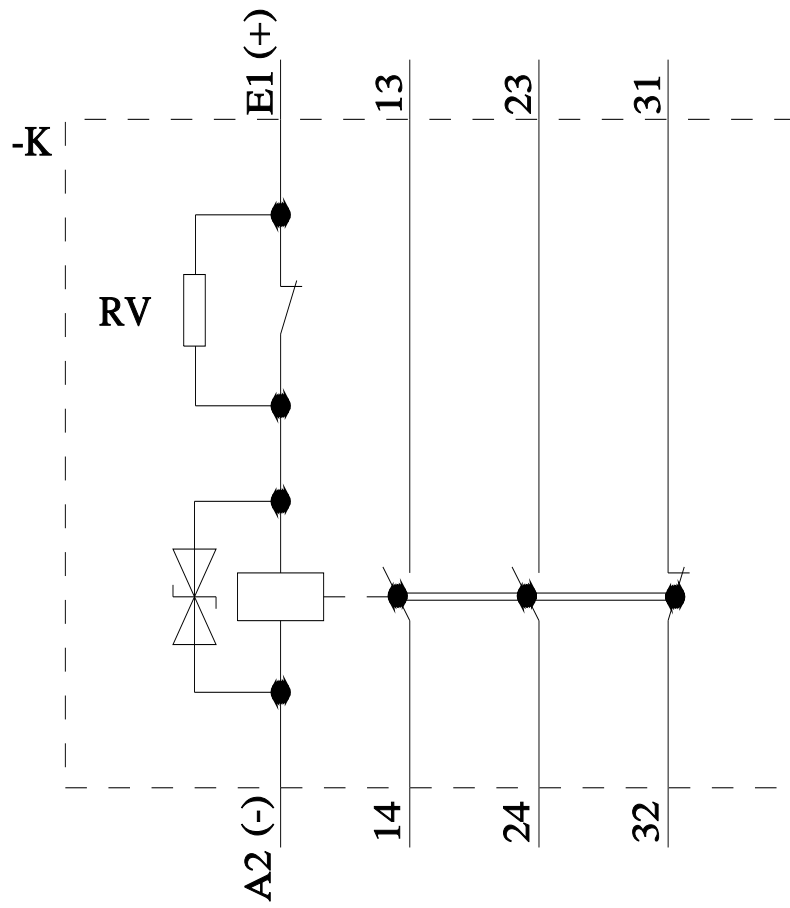

last modified:

4/4/2026 