

Product datasheet

Specifications



Motor circuit breaker, TeSys Deca frame 2, 3P, 13-18A, thermal magnetic, push button, lugs terminals

GV2ME206

⚠ Discontinued on: 1 Dec 2024

⚠ To be discontinued

Main

Range	TeSys Deca
Product name	TeSys GV2
Product or component type	Motor circuit breaker
Device short name	GV2ME
Device application	Motor protection
Trip unit technology	Thermal-magnetic

Complementary

Poles description	3P
Network type	AC
Utilisation category	Category A conforming to IEC 60947-2 AC-3 conforming to IEC 60947-4-1 AC-3e conforming to IEC 60947-4-1
Network frequency	50/60 Hz conforming to IEC 60947-2
Motor power kW	7.5 kW at 400/415 V AC 50/60 Hz 9 kW at 500 V AC 50/60 Hz 15 kW at 690 V AC 50/60 Hz
Breaking capacity	100 kA Icu at 230/240 V AC 50/60 Hz conforming to IEC 60947-2 15 kA Icu at 400/415 V AC 50/60 Hz conforming to IEC 60947-2 8 kA Icu at 440 V AC 50/60 Hz conforming to IEC 60947-2 6 kA Icu at 500 V AC 50/60 Hz conforming to IEC 60947-2 3 kA Icu at 690 V AC 50/60 Hz conforming to IEC 60947-2
[Ics] rated service short-circuit breaking capacity	100 % at 230/240 V AC 50/60 Hz conforming to IEC 60947-2 50 % at 400/415 V AC 50/60 Hz conforming to IEC 60947-2 50 % at 440 V AC 50/60 Hz conforming to IEC 60947-2 75 % at 500 V AC 50/60 Hz conforming to IEC 60947-2 75 % at 690 V AC 50/60 Hz conforming to IEC 60947-2
Control type	Push-button
[In] rated current	18 A
Thermal protection adjustment range	13...18 A conforming to IEC 60947-2
Magnetic tripping current	341 A
[Ith] conventional free air thermal current	18 A conforming to IEC 60947-2
[Ue] rated operational voltage	690 V AC 50/60 Hz conforming to IEC 60947-2
[Ui] rated insulation voltage	690 V AC 50/60 Hz conforming to IEC 60947-2
[Uimp] rated impulse withstand voltage	6 kV conforming to IEC 60947-2
Phase failure sensitivity	Yes conforming to IEC 60947-4-1

Excluding VAT, FCA Jabal Ali & are subject to change – check with your local distributor.

Suitability for isolation	Yes conforming to IEC 60947-1
Power dissipation per pole	2.5 W
Mechanical durability	100000 cycles
Electrical durability	100000 cycles for AC-3 at 415 V In 100000 cycles for AC-3e at 415 V In
Rated duty	Uninterrupted conforming to IEC 60947-4-1
Connections - terminals	Power circuit: lugs-ring terminals 2 cable(s) 1...6 mm ² solid Power circuit: lugs-ring terminals 2 cable(s) 1.5...6 mm ² flexible without cable end Power circuit: lugs-ring terminals 2 cable(s) 1...4 mm ² flexible with cable end
Tightening torque	1.7 N.m - on screw clamp terminal
Fixing mode	35 mm symmetrical DIN rail: clipped Panel: screwed (with adaptor plate)
Mounting position	Horizontal Vertical
Width	45 mm
Height	89 mm
Depth	78.5 mm
Net weight	0.26 kg
Colour	Dark grey
Connection pitch	13.5 mm without spreader

Environment

Standards	EN/IEC 60947-2 EN/IEC 60947-4-1 UL 60947-4-1 CSA C22.2 No 60947-4-1 IEC/EN 60335-2-40:Annex JJ IEC/EN 60335-1:Clause 30.2
Product certifications	CCC UL CSA EAC ATEX LROS (Lloyds register of shipping) BV RINA DNV-GL UKCA
IK degree of protection	IK04
IP degree of protection	IP20 conforming to IEC 60529
Climatic withstand	conforming to IACS E10
Ambient air temperature for storage	-40...80 °C
Fire resistance	960 °C conforming to IEC 60695-2-11
Ambient air temperature for operation	-20...60 °C
Mechanical robustness	Shocks: 30 Gn for 11 ms Vibrations: 5 Gn, 5...150 Hz
Operating altitude	<= 2000 m

Packing Units

Unit Type of Package 1	PCE
Number of Units in Package 1	1

Package 1 Height	4.7 cm
Package 1 Width	8.5 cm
Package 1 Length	9.5 cm
Package 1 Weight	235.0 g
Unit Type of Package 2	S02
Number of Units in Package 2	24
Package 2 Height	15 cm
Package 2 Width	30 cm
Package 2 Length	40 cm
Package 2 Weight	5.64 kg
Unit Type of Package 3	P12
Number of Units in Package 3	768
Package 3 Height	100 cm
Package 3 Width	125 cm
Package 3 Length	55 cm
Package 3 Weight	205.48 kg

Contractual warranty

Warranty (in months)	18
----------------------	----



Environmental Data

Schneider Electric aims to achieve Net Zero status by 2050 through supply chain partnerships, lower impact materials, and circularity via our ongoing “Use Better, Use Longer, Use Again” campaign to extend product lifetimes and recyclability.

[Environmental Data explained >](#)

[How we assess product sustainability >](#)

Environmental footprint

Total lifecycle Carbon footprint	43 kg CO2 eq.
Carbon footprint of the manufacturing phase [A1 to A3]	1 kg CO2 eq.
Carbon footprint of the distribution phase [A4]	0.1 kg CO2 eq.
Carbon footprint of the installation phase [A5]	0 kg CO2 eq.
Carbon footprint of the use phase [B2, B3, B4, B6]	40 kg CO2 eq.
Carbon footprint of the end-of-life phase [C1 to C4]	0.7 kg CO2 eq.
Environmental Disclosure	Product Environmental Profile

Use Better

Materials and Substances

Packaging made with recycled cardboard	Yes
Packaging without single use plastic	Yes
SCIP Number	04104e70-ba29-493c-b2cc-b5837d1f879b
EU RoHS Directive	Compliant By Exemption
REACH Regulation	Reference contains Substances of Very High Concern above the threshold

Use Longer

Lifetime extension

Repair	No
--------	----

Use Again

Repack and remanufacture

Recyclability potential, in %	63
End of life manual availability	End of Life Information
Take-back	No
WEEE Label	The product must be disposed on European Union markets following specific waste collection and never end up in rubbish bins

Performance Curves

Thermal-Magnetic Tripping Curves for GV2ME and GV2P
 Average Operating Times at 20 °C Related to Multiples of the Setting Current

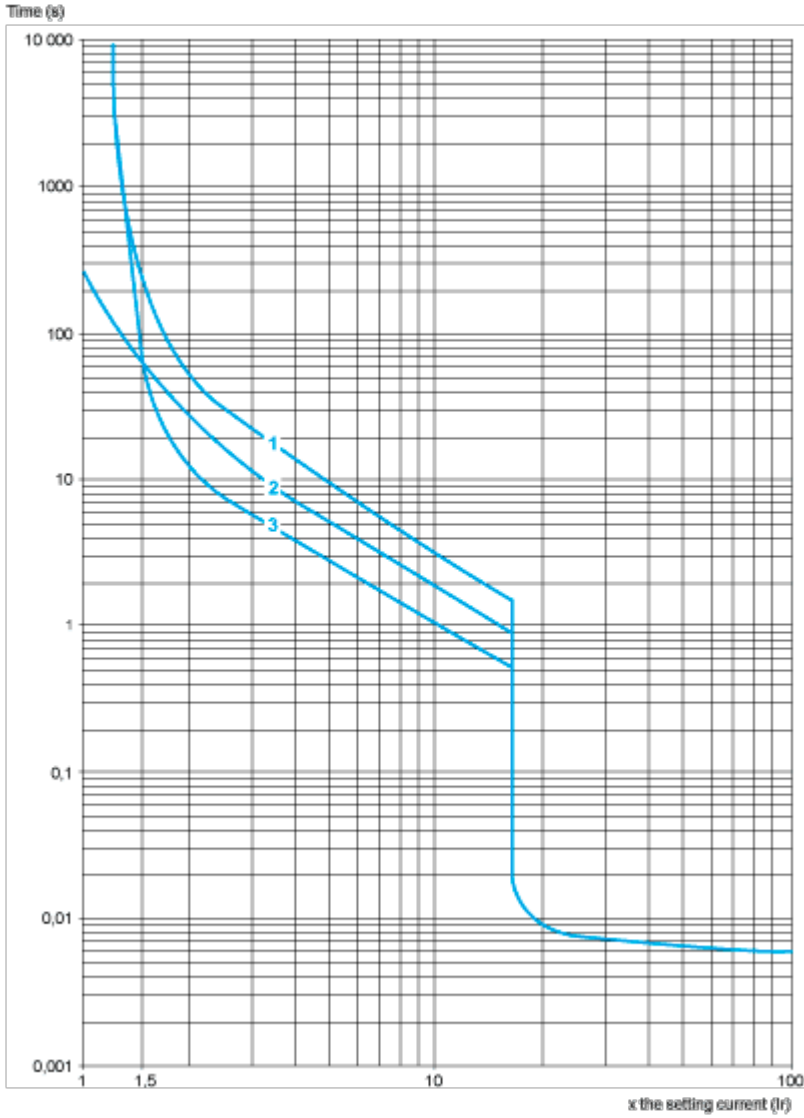

- 1 3 poles from cold state
- 2 2 poles from cold state
- 3 3 poles from hot state

Current Limitation on Short-Circuit for GV2ME and GV2P (3-Phase 400/415 V)

Dynamic Stress

$I_{peak} = f(\text{prospective } I_{sc})$ at $1.05 U_e = 435 V$

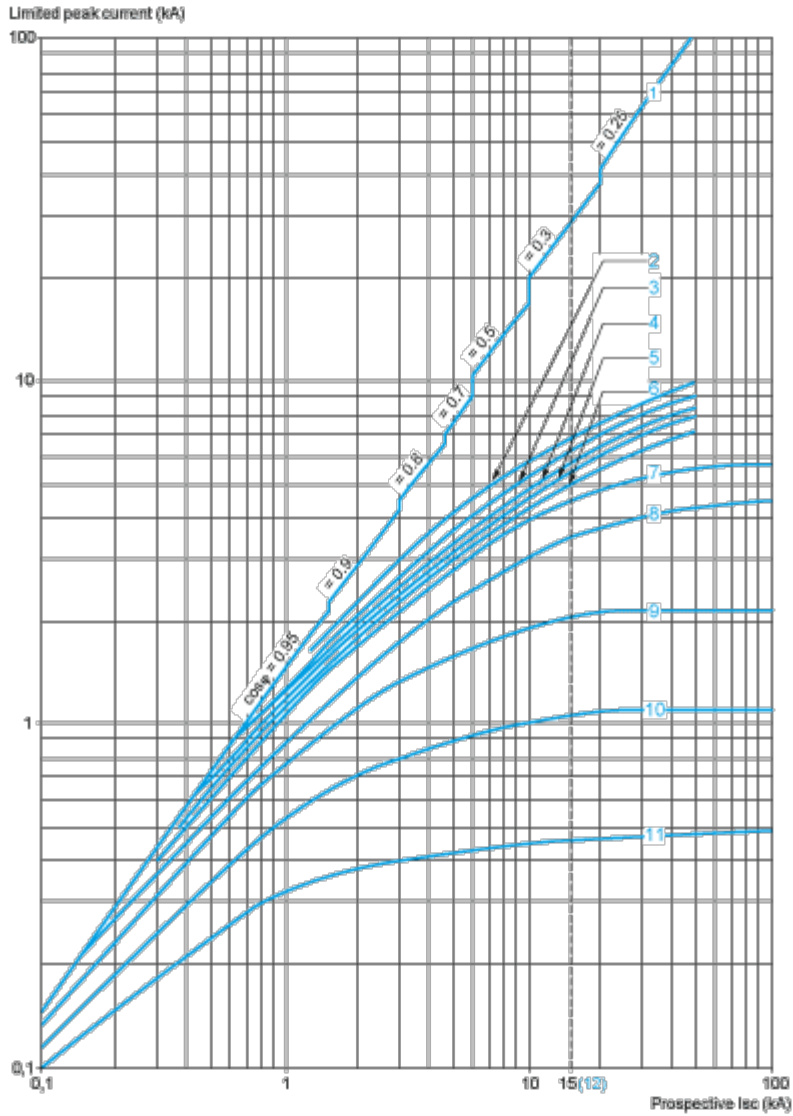

- 1 Maximum peak current
- 2 24-32 A
- 3 20-25 A
- 4 17-23 A
- 5 13-18 A
- 6 9-14 A
- 7 6-10 A
- 8 4-6.3 A
- 9 2.5-4 A
- 10 1.6-2.5 A
- 11 1-1.6 A
- 12 Limit of rated ultimate breaking capacity on short-circuit of GV2ME (14, 18, 23, and 25 A ratings).

Thermal Limit on Short-Circuit for GV2ME

Thermal Limit in kA²s in the Magnetic Operating Zone

Sum of I²dt = f (prospective Isc) at 1.05 Ue = 435 V

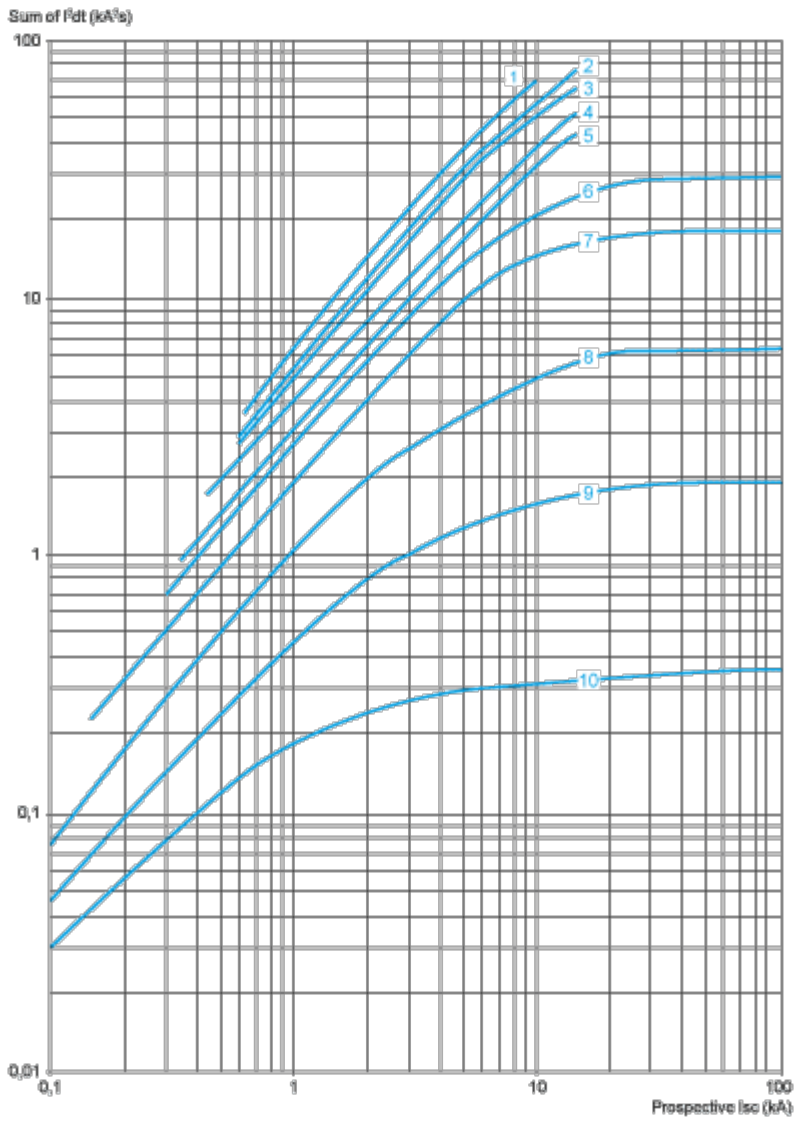

- 1 24-32 A
- 2 20-25 A
- 3 17-23 A
- 4 13-18 A
- 5 9-14 A
- 6 6-10 A
- 7 4-6.3 A
- 8 2.5-4 A
- 9 1.6-2.5 A
- 10 1-1.6 A

Dimensions Drawings

Dimension

GV2ME

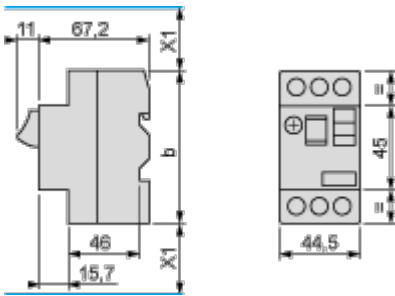

(1) Maximum

X1 Electrical clearance = 40 mm for $U_e \leq 690$ V

	b
GV2ME $\bullet\bullet$	89
GV2ME $\bullet\bullet$ 3	101

Mounting

GV2ME

On 35 mm rail

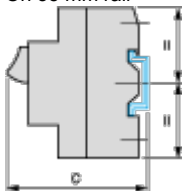

c = 78.5 on AM1 DP200 (35 x 7.5)

c = 86 on AM1 DE200, ED200 (35 x 15)

On panel with adapter plate GV2AF02

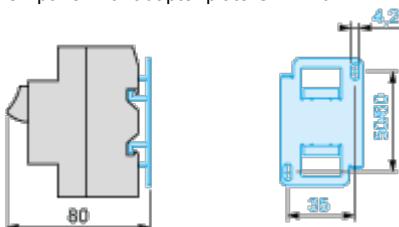

On pre-slotted plate AM1 PA

AF1 EA4

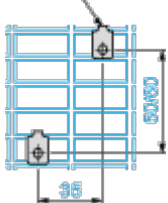

On rails DZ5 MB201

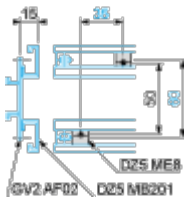

GV2AF01

Combination GV2ME + TeSys k contactor

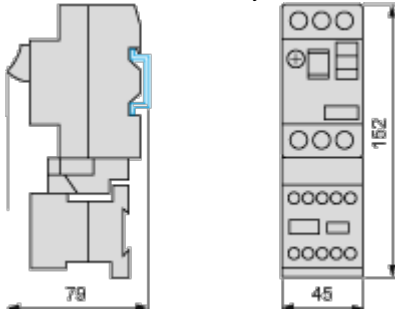

GV2AF3

Combination GV2ME + TeSys d contactor

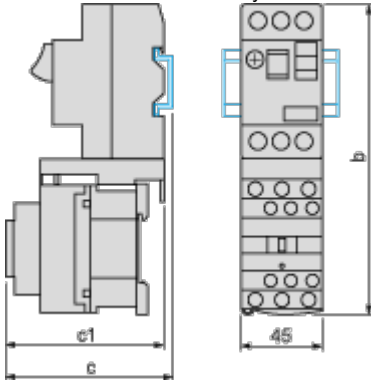

GV2ME +	LC1D09...D18	LC1D25 and D32
b	176.4	186.8
c1	94.1	100.4
c	99.6	105.9

GV2AF4 + LAD311

Combination GV2ME + TeSys d contactor



GV2ME +	LC1D09...D18	LC1D25 and D32
b	176.4	186.8
c1	103.1	136.4
c	135.6	141.9
d1	107	107
d	112.5	112.5

GV2ME + GV1L3 (Current Limiter)

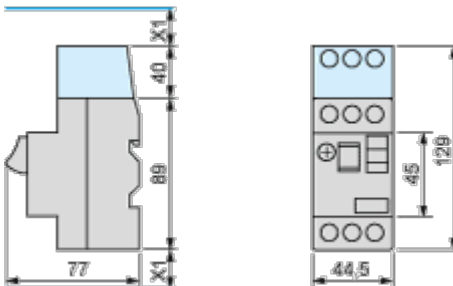

X1 = 10 mm for Ue = 230 V or 30 mm for 230 V < Ue ≤ 690 V

Connections and Schema

GV2ME•• and GV2RT

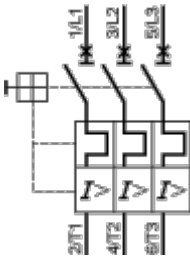

Connection of Undervoltage Trip for Dangerous Machines (Conforming to INRS) on GV2ME Only

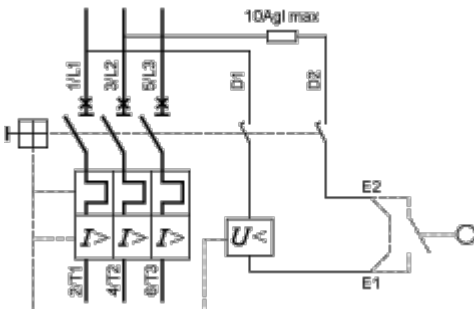

Offer Marketing Illustration

Product benefits / Features

TeSys Deca Motor Circuit Breakers



Universal Integration

Can be used for all type of applications across industry, infrastructure and buildings.



Complete protection

Provide short circuit protection, overload protection, motor (ON/OFF) control, all in a single product.



Standard Sync

Compliant to motor control and protection, in accordance with standards.



Offer Marketing Illustration

Product benefits / Features



TeSys Deca Motor Circuit Breakers
Range Accessories

Energy Sensor

Mounting and adapters

Terminal block

Combination block

Motor starter adapter plate

Current limiter

Comb busbar

Auxiliary contact blocks

The image displays a collection of accessories for TeSys Deca Motor Circuit Breakers. At the top left, a large black motor circuit breaker is shown against a green circular background. Below it, the title 'TeSys Deca Motor Circuit Breakers' is written in a bold, dark grey font, with 'Range Accessories' in a smaller, green font underneath. The accessories are arranged in two rows of four. Each accessory is accompanied by a small image and a text label below it. The first row includes: an Energy Sensor (a white rectangular device with a cable), Mounting and adapters (two grey metal brackets), a Terminal block (a black plastic block with three terminals), and a Combination block (a black plastic block with four terminals). The second row includes: a Motor starter adapter plate (a black metal plate with four terminals), a Current limiter (a black metal component with two terminals), a Comb busbar (a long black metal bar with multiple terminals), and Auxiliary contact blocks (two black plastic blocks with multiple terminals).

Offer Marketing Illustration

Product benefits / Features



The image shows a TeSys Deca Motor Circuit Breaker, a black three-phase device with a red handle. It has three screw terminals at the top labeled 1L1, 3L2, and 5L3, and three at the bottom labeled 2N, 4T, and 6U. A red handle is in the center, with 'OFF' and 'ON' markings. Below the handle is a green 'TRIP' button and a 'RESET' button. A QR code is visible on the front panel. The device is set against a green circular background.

TeSys Deca Motor Circuit Breakers

Technical Benefits

- High breaking capacity up to 100 kA.
- Screw clamp for the connection, with lug and spring terminals.
- Easily identify the tripped breaker.
- Padlockable in all versions.
- Sealable thermal overload settings without additional accessories.
- Short circuit indication for better diagnostics when a trip occurs.
- Maximum 15 current ratings to cover from 0.1 A to 32 A motor current with a IP20 level for finger safety.

Offer Marketing Illustration

Product benefits / Features



TeSys Deca Motor Circuit Breakers

Range Accessories



Energy Sensor



Mounting and adapters



Terminal block

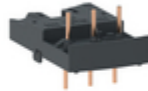

Combination block



Motor starter
adapter plate



Current limiter



Comb busbar



Auxiliary
contact blocks

Offer Marketing Illustration

Product benefits / Features

TeSys Deca Motor Circuit Breakers

Technical Benefits



- High breaking capacity up to 100 kA.
- Screw clamp for the connection, with lug and spring terminals.
- Easily identify the tripped breaker.
- Padlockable in all versions.
- Sealable thermal overload settings without additional accessories.
- Short circuit indication for better diagnostics when a trip occurs.
- Maximum 15 current ratings to cover from 0.1 A to 32 A motor current with a IP20 level for finger safety.

Offer Marketing Illustration

Product benefits / Features

TeSys Deca Motor Circuit Breakers



Universal Integration

Can be used for all type of applications across industry, infrastructure and buildings.



Complete protection

Provide short circuit protection, overload protection, motor (ON/OFF) control, all in a single product.



Standard Sync

Compliant to motor control and protection, in accordance with standards.



Image of product / Alternate images

Alternative



