

Industrial Automation Headquarters

Delta Electronics, Inc.
 Taoyuan Technology Center
 No.18, Xinglong Rd., Taoyuan City,
 Taoyuan County 33068, Taiwan
 TEL: 886-3-362-6301 / FAX: 886-3-371-6301

Asia

Delta Electronics (Jiangsu) Ltd.
 Wujiang Plant 3
 1688 Jiangxing East Road,
 Wujiang Economic Development Zone
 Wujiang City, Jiang Su Province,
 People's Republic of China (Post code: 215200)
 TEL: 86-512-6340-3008 / FAX: 86-769-6340-7290

Delta Greentech (China) Co., Ltd.
 238 Min-Xia Road, Pudong District,
 ShangHai, P.R.C.
 Post code : 201209
 TEL: 86-21-58635678 / FAX: 86-21-58630003

Delta Electronics (Japan), Inc.
 Tokyo Office
 2-1-14 Minato-ku Shibadaimon,
 Tokyo 105-0012, Japan
 TEL: 81-3-5733-1111 / FAX: 81-3-5733-1211

Delta Electronics (Korea), Inc.
 1511, Byucksan Digital Valley 6-cha, Gasan-dong,
 Geumcheon-gu, Seoul, Korea, 153-704
 TEL: 82-2-515-5303 / FAX: 82-2-515-5302

Delta Electronics Int'l (S) Pte Ltd
 4 Kaki Bukit Ave 1, #05-05, Singapore 417939
 TEL: 65-6747-5155 / FAX: 65-6744-9228

Delta Electronics (India) Pvt. Ltd.
 Plot No 43 Sector 35, HSIIDC
 Gurgaon, PIN 122001, Haryana, India
 TEL : 91-124-4874900 / FAX : 91-124-4874945

Americas

Delta Products Corporation (USA)
 Raleigh Office
 P.O. Box 12173,5101 Davis Drive,
 Research Triangle Park, NC 27709, U.S.A.
 TEL: 1-919-767-3800 / FAX: 1-919-767-8080

Delta Greentech (Brasil) S.A
 Sao Paulo Office
 Rua Itapeva, 26 - 3° andar Edificio Itapeva One-Bela Vista
 01332-000-São Paulo-SP-Brazil
 TEL: +55 11 3568-3855 / FAX: +55 11 3568-3865

Europe

Deltronics (The Netherlands) B.V.
 Eindhoven Office
 De Witbogt 15, 5652 AG Eindhoven, The Netherlands
 TEL: 31-40-2592850 / FAX: 31-40-2592851

DVP-0139820-01

*We reserve the right to change the information in this catalogue without prior notice.

20130626

DVP-ES2 Module Manual



DVP-ES2 Module Manual

DVP-ES2 Module Manual

Table of Contents

Chapter 1 Analog Input Module DVP04AD-E2

1.1 The A/D Conversion	1-1
1.2 Introduction	1-1
1.3 Product Profile and Outline	1-1
1.3.1 DVP04AD-E2	1-1
1.4 External Wiring	1-2
1.5 Specifications	1-3
1.6 CR (Control Register).....	1-4
1.6.1 CR in DVP04AD-E2.....	1-4
1.6.2 Explanation on CR	1-5
1.6.3 Explanation on Special Registers D9900~D9999	1-5
1.7 A/D Conversion Curve	1-9
1.7.1 Voltage Input Mode	1-10
1.7.2 Current Input Mode	1-12
1.7.3 Adjusting A/D Conversion Curve in Voltage Input Mode 0 & Mode 2.....	1-13
1.7.4 Adjusting A/D Conversion Curve in Voltage Input Mode 1 & Mode 3.....	1-14
1.7.5 Adjusting A/D Conversion Curve in Current Input Mode 4, Mode 5, and Mode 6 .	1-15
1.8 Applications	1-17
1.8.1 Measuring Current	1-17
1.8.2 Measuring Speed of AC Motor Drive	1-18

Chapter 2 Analog Output Module DVP02DA-E2/DVP04DA-E2

2.1 The D/A Conversion	2-1
2.2 Introduction	2-1
2.3 Product Profile and Outline	2-1
2.3.1 DVP04DA-E2.....	2-1
2.3.2 DVP02DA-E2	2-2
2.4 External Wiring	2-2
2.5 Specifications	2-3
2.6 CR (Control Register).....	2-4
2.6.1 CR in DVP02DA-E2/DVP04DA-E2.....	2-4

2.6.2 Explanation on CR	2-4
2.6.3 Explanation on Special Registers D9900~D9999	2-8
2.7 D/A Conversion Curve	2-8
2.7.1 Voltage Output Mode.....	2-9
2.7.2 Current Output Mode	2-9
2.7.3 Adjusting D/A Conversion Curve in Voltage Output Mode	2-10
2.7.4 Adjusting D/A Conversion Curve in Current Output Mode 1 & Mode 2	2-11
2.8 Applications	2-12
2.8.1 Analog Current Output	2-12
2.8.2 Controlling the Speed of AC Motor Drive	2-13

Chapter 3 Mixed Analog Input/Output Module DVP06XA-E2

3.1 The A/D and D/A Conversion	3-1
3.2 Introduction	3-1
3.3 Product Profile and Outline	3-1
3.3.1 DVP06XA-E2	3-1
3.4 External Wiring	3-2
3.5 Specifications	3-3
3.6 CR (Control Register).....	3-5
3.6.1 CR in DVP06XA-E2.....	3-5
3.6.2 Explanation of CR.....	3-7
3.6.3 Explanation on Special Registers D9900~D9999	3-11
3.7 A/D and D/A Conversion Curve	3-11
3.7.1 Adjusting A/D Conversion Curve of CH1~CH4	3-11
3.7.2 Adjusting D/A Conversion Curve of CH5~CH6	3-14
3.7.3 Adjusting A/D Conversion Curve in Voltage Input Mode 0 & Mode 2.....	3-16
3.7.4 Adjusting A/D Conversion Curve in Voltage Input Mode 1 & Mode 3.....	3-17
3.7.5 Adjusting A/D Conversion Curve in Current Input Mode 4, Mode 5, and Mode 6 ..	3-18
3.7.6 Adjusting D/A Conversion Curve in Voltage Output Mode	3-19
3.7.7 Adjusting D/A Conversion Curve in Current Output Mode 1 and Mode 2.....	3-20
3.8 Applications.....	3-21
3.8.1 Speed Tracing of AC Motor Drive	3-21
3.8.2 How to Set the Module Wizard in WPLSoft	3-22

Chapter 4 Temperature Measurement Module DVP04PT-E2

4.1 The Basic Concept of Platinum Temperature Sensor	4-1
4.2 Introduction	4-1
4.3 Product Profile and Outline	4-1
4.3.1 DVP04PT-E2	4-1
4.4 External Wiring	4-2
4.5 Functions and Specifications	4-2
4.6 CR (Control Register).....	4-3
4.6.1 CR in DVP04PT -E2.....	4-3
4.6.2 Explanation on CR	4-4
4.6.3 Explanation on Special Registers D9900~D9999	4-11
4.7 Temperature Conversion in DVP04PT -E2	4-11
4.7.1 Conversion Curve	4-12
4.7.2 Adjusting PT Conversion Curve	4-13
4.8 Applications	4-13
4.8.1 PT100 Temperature Measurement System	4-13
4.8.2 How to Set the Module Wizard in WPLSoft	4-14
4.9 PID Functions	4-17
4.9.1 Introduction to PID	4-17
4.9.2 PID Control Modes.....	4-19
4.9.3 PID Application Example	4-22

Chapter 5 Temperature Measurement Module DVP04TC-E2

5.1 The Thermocouple Sensor.....	5-1
5.2 Introduction	5-1
5.3 Product Profile and Outline	5-1
5.3.1 DVP04TC-E2	5-1
5.4 External Wiring	5-2
5.5 Functions and Specifications	5-2
5.6 CR (Control Register).....	5-4
5.6.1 CR in DVP04TC -E2.....	5-4
5.6.2 Explanation on CR	5-5
5.6.3 Explanation on Special Registers D9900~D9999	5-11
5.7 Temperature Conversion in DVP04TC -E2	5-11
5.7.1 Conversion Curve	5-12

5.7.2 Adjusting Conversion Curve	5-14
5.8 Applications	5-15
5.8.1 Thermocouple Temperature Measurement System	5-15
5.8.2 How to Set the Module Wizard in WPLSoft	5-16
5.9 PID Functions	5-19
5.9.1 Introduction to PID	5-19
5.9.2 PID Control Modes.....	5-21
5.9.3 PID Application Example	5-24
5.10 Hardware Properties of Temperature Controllers.....	5-25

1.1 The A/D Conversion

In industrial automation, many measuring units are transmitted by analog signals. The most frequently adopted range for the signals are voltage -10V ~ 10V and current -20mA ~ 20mA. To use the analog signals as the parameters for PLC operations, you have to convert them into digital values first.

For example, the voltage -10V ~ 10V is first converted into values -32,000 ~ +32,000 by an A/D module, and the PLC will read/write the control registers (CR) in the A/D module. The signals sent back to the PLC for operations will be digital K-32,000 ~ K32,000.

1.2 Introduction

DVP04AD-E2 analog signal input module receives external 4 points of analog input signals (voltage or current) and converts them into 16-bit digital signals. The Main Processing Unit (MPU) can read/write the data in the module by using FROM/TO instructions or D9900~D9999 in the program. You can select voltage input or current input by the wiring. Range for voltage input: $\pm 10V$ ($\pm 32,000$). Range for current input: $\pm 20mA$ ($\pm 32,000$).

1.3 Product Profile and Outline

1.3.1 DVP04AD-E2

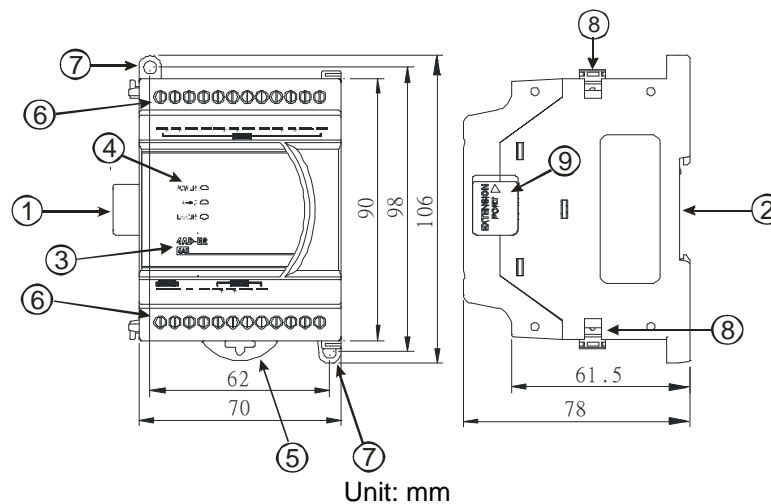

1. Connection port for extension unit/module	6. Terminals
2. DIN rail (35mm)	7. Mounting hole
3. Model name	8. Fixing clip for extension unit/module
4. POWER, ERROR, A→D indicators	9. Mounting port for extension unit/module
5. DIN rail clip	

I/O terminals

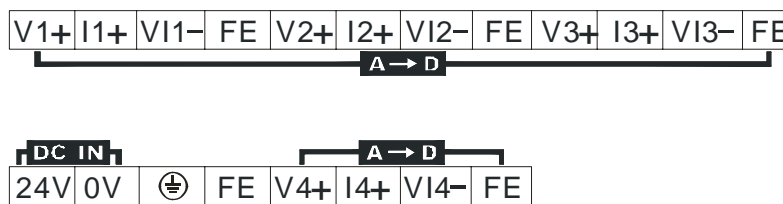

1 Analog Input Module DVP04AD-E2

1.4 External Wiring

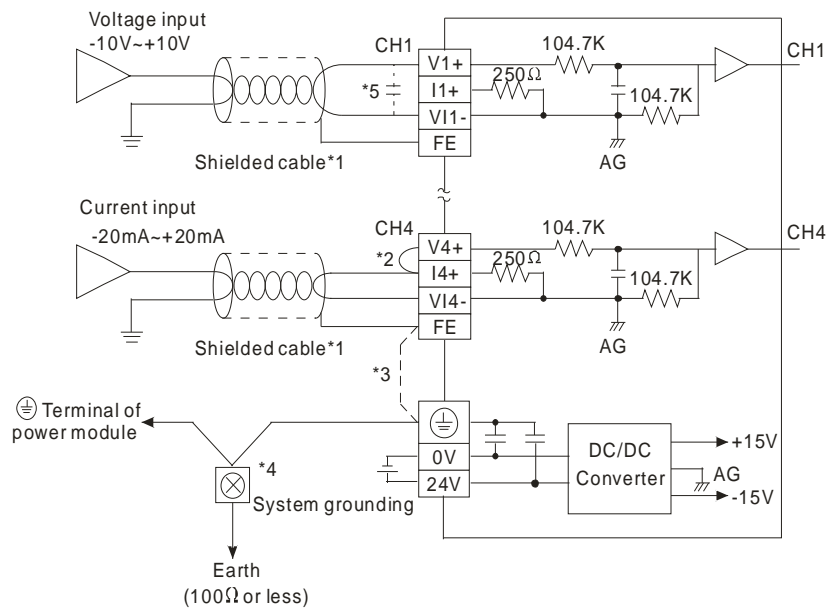

- *1: When performing analog input, please isolate other power wirings.
- *2: When the A/D module is connected to current signals, make sure you short-circuit “V+” and “I+” terminals.
- *3: If the noise is too significant, please connect FE to the grounding terminal.
- *4: Please connect the \oplus terminal on both the power module and A/D module to the system earth point and ground the system contact or connect it to the cover of power distribution cabinet.
- *5: If the ripples at the loaded input terminal are too significant that causes noise interference on the wiring, connect the wiring to 0.1 ~ 0.47 μ F 25V capacitor.

1.5 Specifications

DVP04AD-E2	Voltage input		Current input		
Power supply voltage	24 VDC (20.4VDC ~ 28.8VDC) (-15% ~ +20%)				
Connector	European standard fixed terminal block (Pin pitch: 5mm)				
Analog input channel	4 channels				
Range of analog input	±10V	±5V	±20mA	0~20mA	4~20mA
Range of digital conversion	±32,000	±32,000	±32,000	0~32,000	0~32,000
Max./Min. output range of digital data	±32,384	±32,384	±32,384	-384~+32,384	-384~+32,384
Resolution	14 bits 20V/64000	14 bits 10V/64000	14 bits 40mA/64000	13 bits 20mA/32000	13 bits 16mA/32000
Input impedance	> 200 KΩ		250Ω		
Overall accuracy	±0.5% when in full scale (25°C, 77°F) ±1% when in full scale within the range of 0 ~ 55°C (32 ~ 131°F)				
Response time	3 ms / all channels				
Isolation	Optical coupler isolation between digital circuits and analog circuits. No isolation among analog channels. 500VDC between digital circuits and Ground 500VDC between analog circuits and Ground 500VDC between analog circuits and digital circuits 500VDC between 24VDC and Ground				
Range of absolute input	±15V		±32mA		
Digital data format	16 significant bits out of 16 bits are available; in 2's complement				
Average function	Supported. Available for setting up average times in CR#8 ~ CR#11. Range: K1 ~ K100.				
Self-diagnosis	Upper and lower bound detection in all channels				
Series connection to DVP-PLC MPU	The modules are numbered from 0 to 7 automatically by their distance from MPU. Max. 8 modules are allowed to connect to MPU and will not occupy any digital I/O points.				
A/D conversion curve (Default: mode 0)	Mode 0 (H'0000): (-10V ~ +10V)		Mode 1 (H'0001): (-5V ~ +5V)		
	Mode 2 (H'0002): (0V ~ +10V)		Mode 3 (H'0003): (0V ~ +5V)		

1 Analog Input Module DVP04AD-E2

DVP04AD-E2	Voltage input	Current input
A/D conversion curve (Default: mode 0)	Mode 4 (H'0004): (-20mA ~ +20mA) 	Mode 5 (H'0005): (0 ~ +20mA)
	Mode 6 (H'0006): (+4mA ~ +20mA) 	Mode -1 (H'FFFF): Channel unavailable. Average value and present value of input channels will be displayed as 32,767(H'7FFF).
Operation/storage temperature	1. Operation: 0°C ~ 55°C (temperature), 50 ~ 95% (humidity), pollution degree 2 2. Storage: -25°C ~ 70°C (temperature), 5 ~ 95% (humidity)	
Vibration/shock immunity	International standards: IEC61131-2, IEC 68-2-6 (TEST Fc)/IEC61131-2 & IEC 68-2-27 (TEST Ea)	
Power supply		
Max. rated power consumption	24VDC (20.4VDC ~ 28.8VDC) (-15% ~ +20%), 3W, supplied by external power source	

1.6 CR (Control Register)

1.6.1 CR in DVP04AD-E2

DVP04AD-E2				Description
CR#	Attrib.	Register content		
#0	YES	R	Model name	Set up by the system: DVP04AD-E2 model code = H'0080
#1	YES	R	Firmware version	Display the current firmware version in hex.
#2	YES	R/W	CH1 Input mode setting	Input mode: Default = H'0000. Take CH1 for example: Mode 0 (H'0000): Voltage input (-10V ~ +10V). Mode 1 (H'0001): Voltage input (-5V ~ +5V). Mode 2 (H'0002): Voltage input (0V ~ +10V). Mode 3 (H'0003): Voltage input (0V ~ +5V). Mode 4 (H'0004): Current input (-20mA ~ +20mA). Mode 5 (H'0005): Current input (0mA ~ +20mA). Mode 6 (H'0006): Current input (4mA ~ +20mA). Mode -1 (H'FFFF): Channel 1 unavailable
#3	YES	R/W	CH2 Input mode setting	
#4	YES	R/W	CH3 Input mode setting	
#5	YES	R/W	CH4 Input mode setting	
#6 ~ #7			Reserved	
#8	YES	R/W	CH1 average times	Set average times in CH1 ~ CH2: Range = K1 ~ K100 Default = K10
#9	YES	R/W	CH2 average times	
#10	YES	R/W	CH3 average times	Set average times in CH3 ~ CH4: Range = K1 ~ K100 Default = K10
#11	YES	R/W	CH4 average times	
#12	NO	R	CH1 average input value	Average value of input signals at CH1 ~ CH4
#13	NO	R	CH2 average input value	
#14	NO	R	CH3 average input value	
#15	NO	R	CH4 average input value	
#16 ~ #19			Reserved	

DVP04AD-E2				Description
CR#	Attrib.		Register content	
#20	NO	R	CH1 present input value	Present value of input signals at CH1 ~ CH4
#21	NO	R	CH2 present input value	
#22	NO	R	CH3 present input value	
#23	NO	R	CH4 present input value	
#24 ~ #27			Reserved	
#28	YES	R/W	Adjusted Offset value of CH1	Set the adjusted Offset value of CH1 ~ CH4. Default = K0 Definition of Offset in DVP04AD-E2: The corresponding voltage (current) input value when the digital output value = 0.
#29	YES	R/W	Adjusted Offset value of CH2	
#30	YES	R/W	Adjusted Offset value of CH3	
#31	YES	R/W	Adjusted Offset value of CH4	
#32 ~ #33			Reserved	
#34	YES	R/W	Adjusted Gain value of CH1	Set the adjusted Gain value in CH1 ~ CH4. Default = K16,000 Definition of Gain in DVP04AD-E2: The corresponding voltage (current) input value when the digital output value = 16,000.
#35	YES	R/W	Adjusted Gain value of CH2	
#36	YES	R/W	Adjusted Gain value of CH3	
#37	YES	R/W	Adjusted Gain value of CH4	
#38 ~ #39			Reserved	
#40	YES	R/W	Function: Set value changing prohibited	Prohibit set value changing in CH1 ~ CH4
#41	NO	R/W	Function: Save all the set values	Save all the set values, Default =H'0000
#42	NO	R/W	Function: Return to default setting	Set all values to default setting, Default = H'0000
#43	NO	R	Error status	Register for storing all error status. Refer to table of error status for more information.
#44 ~ #99			Reserved	
#100	YES	R/W	Function: Enable/Disable limit detection	Enable/Disable the upper and lower bound detection function.
#101	NO	R/W	Upper and lower bound status	Display the upper and lower bound value. Default = H'0000
#102	YES	R/W	Set value of CH1 upper bound	Set value of CH1~CH4 upper bound. Default = K32,000
#103	YES	R/W	Set value of CH2 upper bound	
#104	YES	R/W	Set value of CH3 upper bound	
#105	YES	R/W	Set value of CH4 upper bound	
#106 ~ #107			Reserved	
#108	YES	R/W	Set value of CH1 lower bound	Set value of CH1~CH4 lower bound. Default = K-32,000
#109	YES	R/W	Set value of CH2 lower bound	
#110	YES	R/W	Set value of CH3 lower bound	
#111	YES	R/W	Set value of CH4 lower bound	
Symbols: YES: When CR#41 is set to H'5678, the set value of CR will be saved. NO: Set value will not be saved R: Able to read data by FROM instruction, W: Able to write data by using TO instruction For voltage input Mode0/Mode2: $0.3125\text{mV} = 20\text{V}/64,000 = 10\text{V}/32,000$ For voltage input Mode1/Mode3: $0.15625\text{mV} = 10\text{V}/64,000 = 5\text{V}/32,000$ For current input Mode4/Mode5: $0.625\mu\text{A} = 40\text{mA}/64,000 = 20\text{mA}/32,000$ For current input Mode6: $0.5\mu\text{A} = 16\text{mA}/32,000$				

1.6.2 Explanation on CR

CR#0: Model name

[Explanation]

1. DVP04AD-E2 model code = H'0080
2. You can read the model name in the program to see if the extension module exists.

CR#1: Firmware version

[Explanation]

Display the current firmware version in hex, e.g. version V1.00 is indicated as H'0100.

CR#2, 3, 4, 5: CH1 ~ CH4 input mode setting

[Explanation]

Set the working mode of the channels in the analog input module. There are 8 modes for each channel which can be set up separately.

When you set CH1 as mode 1 (H'0001) CR#2 has to be set as H'0001. The default setting = H'0000. Take CH1 as example:

- Mode 0 (H'0000): Voltage input (-10V ~ +10V).
- Mode 1 (H'0001): Voltage input (-5V ~ +5V).
- Mode 2 (H'0002): Voltage input (0V ~ +10V).
- Mode 3 (H'0003): Voltage input (0V ~ +5V).
- Mode 4 (H'0004): Current input (-20mA ~ +20mA).
- Mode 5 (H'0005): Current input (0mA ~ +20mA).
- Mode -1 (H'FFFF): Channel 1 unavailable.

CR#8, 9, 10, 11: CH1 ~ CH4 average times

[Explanation]

1. The average times of the signals at CH1 ~ CH4.
2. Setup range for DVP04AD-E2: K1 ~ K100. Default = K10. If the set value exceeds K100, the value will be set as K100; if the set value is lower than K1, the set value will be set as K1.

CR#12, 13, 14, 15: Average input values in CH1 ~ CH4

[Explanation]

The average value of the signals at CH1 ~ CH4 is calculated according to the average times set in CR#8 ~ CR#11. For example, if the set value in CR#8 ~ CR#11 is K20, the content in CR#12 ~ CR#15 will be the average of the most recent 20 signals in CH1 ~ CH4.

CR#20, 21, 22, 23: Present input value at CH1 ~ CH4

[Explanation]

Display the present value of input signals in CH1 ~ CH4.

CR#28, 29, 30, 31: Adjusted Offset value of CH1 ~ CH4

[Explanation]

1. Set the adjusted Offset value of CH1 ~ CH4, which represents the corresponding voltage (current) input value when the digital output value = 0
2. Default setting = K0.

CR#34, 35, 36, 37: Adjusted Gain value of CH1 ~ CH4

[Explanation]

1. Set the adjusted Gain value of CH1 ~ CH4, which represents the corresponding voltage (current) input value when the digital output value = 16,000.
2. Default setting = K16,000.

CR#40: Function: Set value changing prohibited, Default = H'0000

[Explanation]

Description	
bit0	b0=0, CH1 changing allowed; b0=1, CH1 changing prohibited
bit1	b1=0, CH2 changing allowed; b1=1, CH2 changing prohibited
bit2	b2=0, CH3 changing allowed; b2=1, CH3 changing prohibited
bit3	b3=0, CH4 changing allowed; b3=1, CH4 changing prohibited
bit4 ~ bit15	Reserved

Relative Parameters	
CR#2 ~ CR#5	Input mode setting at CH1 ~ CH4
CR#8 ~ CR#11	Average times of CH1 ~ CH4
CR#28 ~ CR#31	Adjusted Offset value of CH1 ~ CH4
CR#34 ~ CR#37	Adjusted Gain value of CH1 ~ CH4
CR#42	Return to default setting

Relative Parameters	
CR#100	Function: Enable/Disable limit detection
CR#102~CR#105	Set value of CH1~CH4 upper bound
CR#108~CR#111	Set value of CH1~CH4 lower bound

CR#41: Function: Save all the set values. Default=H0000

[Explanation]

Save function setting. Save all the set values to the internal flash memory. When saving is completed, CR#41 will be set to H'FFFF.

Set value	Function
H0	No action
HFFFF	Saving completed
H5678	Saving enabled.

Note: Default setting = H0. When set value = H'5678, saving will be enabled, and CR#41 will be set to H'FFFF when saving is completed. If the set value is not H'5678, the set value will remain H'0. For example, input K1 into CR#41, and the value will remain H'0.

CR#42: Function: Return to default setting. Default=H0000

[Explanation]

Description	
bit0	b0=0, no action on CH1; b0=1, set CH1 to default setting
bit1	b1=0, no action on CH2; b1=1, set CH2 to default setting
bit2	b2=0, no action on CH3; b2=1, set CH3 to default setting
bit3	b3=0, no action on CH4; b3=1, set CH4 to default setting
bit4 ~ bit15	Reserved

Note: Set designated bit as 1 and the corresponding channel will be returned to default setting. When setting is completed, the value will be set to 0. If CR#40(Set value changing prohibited) is enabled, the default setting in CR#42 will be invalid, and all set values will remain unchanged. Error Code bit 12 of CR#43 will be set to 1.

Relative Parameters	
CR#2 ~ CR#5	Input mode setting of CH1 ~ CH4
CR#8 ~ CR#11	Average times of CH1 ~ CH4
CR#28 ~ CR#31	Adjusted Offset value of CH1 ~ CH4
CR#34 ~ CR#37	Adjusted Gain value of CH1 ~ CH4
CR#100	Function: Enable/Disable limit detection
CR#102~CR#105	Set value of CH1~CH4 upper bound
CR#108~CR#111	Set value of CH1~CH4 lower bound

CR#43: Error status. Default=H'0000

[Explanation]

CR#43: error status value. See the table below:

Description		
bit0	K1 (H'1)	Power supply error
bit1	K2 (H'2)	Hardware error
bit2	K4 (H'4)	Upper / lower bound error
bit3	K8 (H'8)	CH1 Conversion error
bit4	K16 (H'10)	CH2 Conversion error
bit5	K32 (H'20)	CH3 Conversion error
bit6	K64 (H'40)	CH4 Conversion error
bit7 ~ bit8		Reserved
bit9	K512(H'0200)	Mode setting error
bit10	K1024(H'0400)	Average times error
bit11	K2048(H'0800)	Upper / lower bound setting error
bit12	K4096(H'1000)	Set value changing prohibited
bit13	K8192(H'2000)	Communication breakdown on next module
bit14 ~ bit15		Reserved

 **Note:** Each error status is determined by the corresponding bit (b0 ~ b13) and there may be more than 2 errors occurring at the same time. 0 = normal; 1 = error

CR#100: Function: Enable/Disable limit detection

[Explanation]

Description	
bit0=1	Enable CH1 limit detection
bit1=1	Enable CH2 limit detection
bit2=1	Enable CH3 limit detection
bit3=1	Enable CH4 limit detection
bit4 ~ bit15	Reserved

CR#101: Upper and lower bound status

[Explanation]

Description	
bit0=1	CH1 exceeds lower bound
bit1=1	CH2 exceeds lower bound
bit2=1	CH3 exceeds lower bound
bit3=1	CH4 exceeds lower bound
bit4 ~ bit7	Reserved
bit8=1	CH1 exceeds upper bound
bit9=1	CH2 exceeds upper bound
bit10=1	CH3 exceeds upper bound
bit11=1	CH4 exceeds upper bound
bit12 ~ bit15	Reserved

CR#102, 103, 104, 105: Set value of CH1 ~ CH4 upper bound

[Explanation]

Set the upper bound value of CH1 ~ CH4. Default = K32,000

CR#108, 109, 110, 111: Set value of CH1 ~ CH4 lower bound

[Explanation]

Set the lower bound value of CH1 ~ CH4. Default = K-32,000

1.6.3 Explanation on Special Registers D9900~D9999

When ES2 MPU is connected with modules, registers D9900~D9999 will be reserved for storing values from modules. You can apply MOV instruction to operate values in D9900~D9999.

When ES2 MPU is connected with DVP04AD-E2, the configuration of special registers is as below:

Module#0	Module #1	Module #2	Module #3	Module #4	Module #5	Module #6	Module #7	Description
D1320	D1321	D1322	D1323	D1324	D1325	D1326	D1327	Model code
D9900	D9910	D9920	D9930	D9940	D9950	D9960	D9970	CH1 average input value
D9901	D9911	D9921	D9931	D9941	D9951	D9961	D9971	CH2 average input value
D9902	D9912	D9922	D9932	D9942	D9952	D9962	D9972	CH3 average input value
D9903	D9913	D9923	D9933	D9943	D9953	D9963	D9973	CH4 average input value

- D9900~D9999 are average input values of CH1 ~ CH4 and the average times is K1~K100. When the average times is set to K1, the values displayed in D9900~D9999 are current values. You can use: 1. ES_AIO Configuration Function of WPLSoft (refer to **1.8 Applications** in this manual) or 2. FROM/TO instructions (CR#8~CR#11) to set the average times as K1.

- Example:

Ladder diagram:

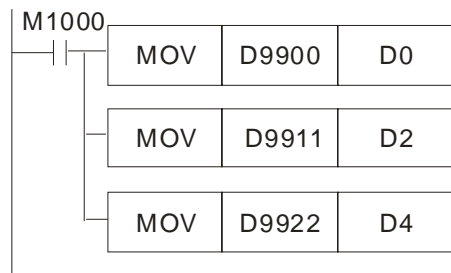

Explanation:

Save CH1 average input value of Module#0 to D0

Save CH2 average input value of Module#1 to D2

Save CH3 average input value of Module#2 to D4

1.7 A/D Conversion Curve

You can adjust the conversion curves according to the actual needs by changing the Offset value (CR#28 ~ CR#31) and Gain value (CR#34 ~ CR#37).

Gain (in DVP04AD-E2): The corresponding voltage/current input value when the digital output value = 16,000.

Offset (in DVP04AD-E2): The corresponding voltage/current input value when the digital output value = 0.

- For voltage input Mode0/Mode2: $0.3125\text{mV} = 20\text{V}/64,000 = 10\text{V}/32,000$

Equation:

$$Y = \frac{16000 \times \left(\frac{X(V)}{10(V)} \times 32000 - \text{Offset} \right)}{\text{Gain} - \text{Offset}}$$

Y=Digital output, X=Voltage input

- For voltage input Mode1/Mode3: $0.15625\text{mV} = 10\text{V}/64,000 = 5\text{V}/32,000$

Equation:

$$Y = \frac{16000 \times \left(\frac{X(V)}{5(V)} \times 32000 - \text{Offset} \right)}{\text{Gain} - \text{Offset}}$$

Y=Digital output, X=Voltage input

- For current input Mode4/Mode5: $0.625 \mu\text{A} = 40\text{mA}/64,000 = 20\text{mA}/32,000$

Equation:

$$Y = \frac{16000 \times \left(\frac{X(\text{mA})}{20(\text{mA})} \times 32000 - \text{Offset} \right)}{\text{Gain} - \text{Offset}}$$

Y=Digital output, X= Current input

1 Analog Input Module DVP04AD-E2

- For current input Mode6: $0.5 \mu A = 16mA/32,000$
Adopt the Equation of current input Mode4/Mode5, substitute Gain for 19200 (12mA) and Offset for 6400 (4mA)
Equation:

$$Y = \frac{16000 \times \left(\frac{X(mA)}{20(mA)} \times 32000 - 6400 \right)}{(19200 - 6400)}$$

Y=Digital output, X= Current input

1.7.1 Voltage Input Mode

- Mode 0 (H'0000): (-10V ~ +10V)

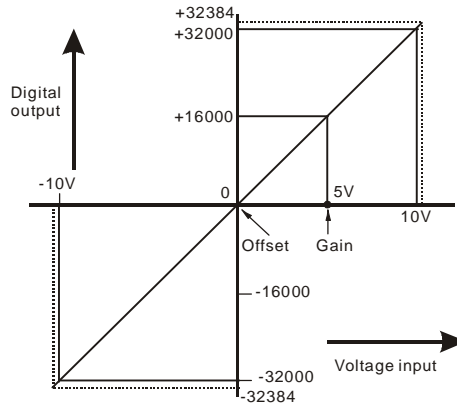

Mode 0 of CR#2~ CR#5	-10V ~ +10V, Gain = 5V (16,000), Offset = 0V (0).
Gain (CR#28 ~ CR#31)	The corresponding voltage input value when the digital output value = 16,000.
Offset (CR#34 ~ CR#37)	The corresponding voltage input value when the digital output value = 0.
Range of digital conversion	-32,000 ~ +32,000
Max./Min. output range of digital data	-32,384 ~ +32,384

- Mode 1 (H'0001): (-5V ~ +5V)

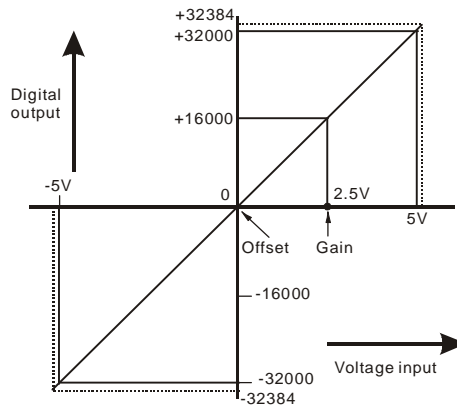

Mode 1 of CR#2~ CR#5	-5V ~ +5V, Gain = 2.5V (16,000), Offset = 0V (0).
Gain (CR#28 ~ CR#31)	The corresponding voltage input value when the digital output value = 16,000.
Offset (CR#34 ~ CR#37)	The corresponding voltage input value when the digital output value = 0.
Range of digital conversion	-32,000 ~ +32,000
Max./Min. output range of digital data	-32,384 ~ +32,384

- Mode 2 (H'0002): (0V~+10V)

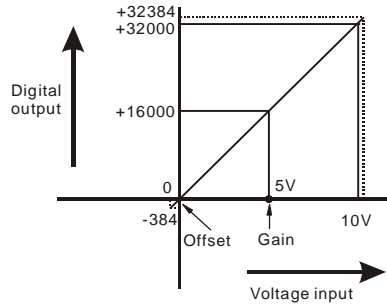

Mode 2 of CR#2~ CR#5	0V ~ +10V, Gain = 5V (16,000), Offset = 0V (0).
Gain (CR#28 ~ CR#31)	The corresponding voltage input value when the digital output value = 16,000.
Offset (CR#34 ~ CR#37)	The corresponding voltage input value when the digital output value = 0.
Range of digital conversion	0 ~ 32,000
Max./Min. output range of digital data	-384 ~ +32,384

- Mode 3 (H'0003): (0V~+5V)

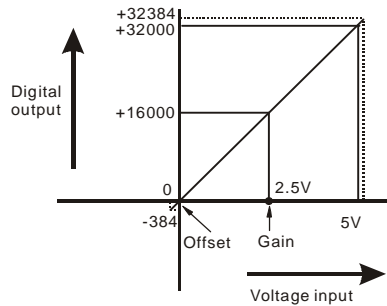

Mode 3 of CR#2~ CR#5	0V ~ +5V, Gain = 2.5V (16,000), Offset = 0V (0).
Gain (CR#28 ~ CR#31)	The corresponding voltage input value when the digital output value = 16,000.
Offset (CR#34 ~ CR#37)	The corresponding voltage input value when the digital output value = 0.
Range of digital conversion	0 ~ 32,000
Max./Min. output range of digital data	-384 ~ +32,384

1 Analog Input Module DVP04AD-E2

1.7.2 Current Input Mode:

- Mode 4 (H'0004): (-20mA~ +20mA)

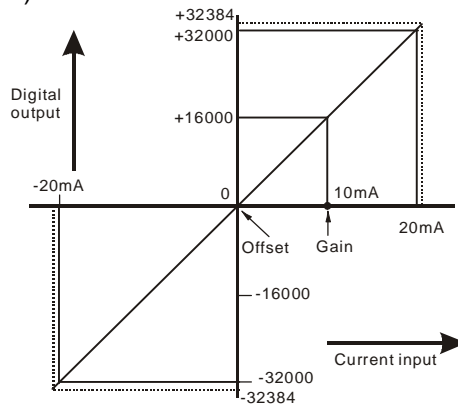

Mode 4 of CR#2~ CR#5	-20mA ~ +20mA, Gain = 10mA (16,000), Offset = 0mA (0).
Gain (CR#28 ~ CR#31)	The corresponding current input value when the digital output value = 16,000.
Offset (CR#34 ~ CR#37)	The corresponding current input value when the digital output value = 0.
Range of digital conversion	-32,000 ~ +32,000
Max./Min. output range of digital data	-32,384 ~ +32,384

- Mode 5 (H'0005): (0 ~ +20mA)

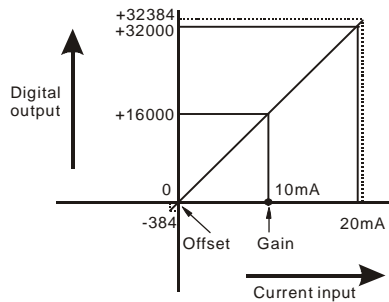

Mode 5 of CR#2~ CR#5	0mA ~ +20mA, Gain = 10mA (16,000), Offset = 0mA (0).
Gain (CR#28 ~ CR#31)	The corresponding current input value when the digital output value = 16,000.
Offset (CR#34 ~ CR#37)	The corresponding current input value when the digital output value = 0.
Range of digital conversion	0 ~ 32,000
Max./Min. output range of digital data	-384 ~ +32,384

- Mode 6 (H'0006): (+4mA ~ +20mA)

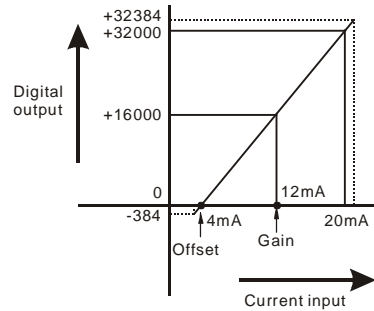

Mode 6 of CR#2~ CR#5	+4mA ~ +20mA, Gain = 12mA (19,200), Offset = 4mA (6,400).
Gain (CR#28 ~ CR#31)	The corresponding current input value when the digital output value = 16,000.
Offset (CR#34 ~ CR#37)	The corresponding current input value when the digital output value = 0.
Range of digital conversion	0 ~ 32,000
Max./Min. output range of digital data	-384 ~ +32,384

1.7.3 Adjusting A/D Conversion Curve in Voltage Input Mode 0 & Mode2

1. Description

- Take 04AD CH1 for example, when CR#2 is set as voltage input mode (mode 0), the Offset value will be set as 0V (0) and Gain value as 5V (5V/0.3215mV=16,000), i.e. input voltage -10V ~ +10V will correspond to values -32,000 ~ +32,000.
- When CR#2 is set as voltage input mode (mode 2), the Offset value will be set as 0V (0) and Gain value as 5V (5V/0.3215mV=16,000), i.e. input voltage 0V ~ +10V will correspond to values 0 ~ +32,000.
- If you cannot use the default voltage input mode (mode 0 and mode 2), you can make adjustments on the A/D conversion curve according to your actual needs. For example, set the Offset of CH1 as 2V (2V/0.3215mV=6,400) and Gain as 6V (6V/0.3215mV=19,200).

$$Y = \frac{16000 \times \left(\frac{X(V)}{10(V)} \times 32000 - \text{Offset} \right)}{\text{Gain} - \text{Offset}}$$

Example: If X=6V, Y=?

$$Y = \frac{16000 \times \left(\frac{6(V)}{10(V)} \times 32000 - 6400 \right)}{(19200 - 6400)} = 16000$$

- You only need to set up the A/D conversion curve for once. Set up CR#40 (Set value changing prohibited) to prevent incorrect operations.

2. Adjusted Curve

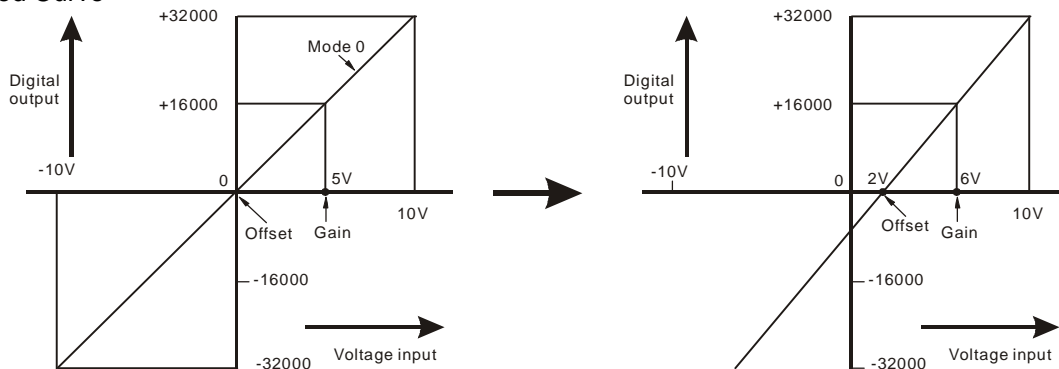

3. Devices

- X0 = On: Set the input mode of the signals in CH1 as mode 0.
- X1 = On: Set Offset value of CH1 as 2V (6,400) and Gain value as 6V (19,200).
- M0 = On: Disable CH1 set value changing.

1 Analog Input Module DVP04AD-E2

4. Program explanation

- When X0 = On, set CR#2 as K0 (H'0000) and the signal input mode at CH1 as mode 0 (voltage input mode).
- When X1 = On, write K6,400 (Offset value of CH1) into CR#28 and K19,200 (Gain value of CH1) into CR#34.
- When X1 goes from On to Off, set M0 = On to disable the adjustment on A/D conversion curve. Write K1 (H'1) into CR#40 b0=1 to disable CH1 set value changing.

5. Program example

Ladder diagram:

Explanation:

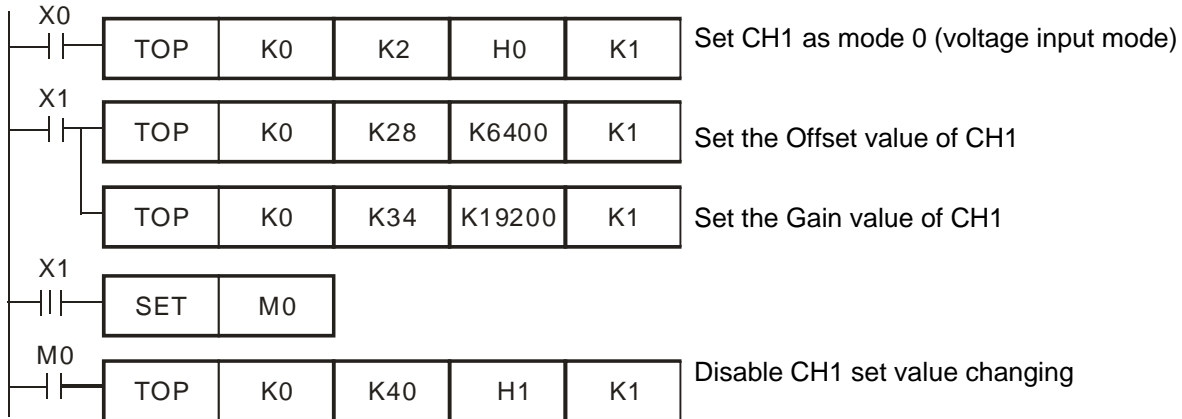

1.7.4 Adjusting A/D Conversion Curve in Voltage Input Mode 1 & Mode 3

1. Description

- Take 04AD CH2 for example, when CR#3 is set as voltage input mode (mode 1), the Offset value will be set as 0V (0) and Gain value as 2.5V (2.5V/0.15625mV=16,000), i.e. input voltage -5V ~ +5V will correspond to values -32,000 ~ +32,000.
- When CR#3 is set as voltage input mode (mode 3), the Offset value will be set as 0V (0) and Gain value as 2.5V (2.5V/0.15625mV=16,000), i.e. input voltage 0V ~ +5V will correspond to values 0 ~ +32,000.
- If you cannot use the default voltage input mode (mode 1 and mode 3), you can make adjustments on the A/D conversion curve according to your actual needs. For example, set the Offset of CH2 as 1V (1V/0.15625mV=6,400) and Gain as 3V (3V/0.15625mV=19,200).

$$Y = \frac{16000 \times \left(\frac{X(V)}{5(V)} \times 32000 - \text{Offset} \right)}{\text{Gain} - \text{Offset}}$$

Example: If X=3V, Y=?

$$Y = \frac{16000 \times \left(\frac{3(V)}{5(V)} \times 32000 - 6400 \right)}{19200 - 6400} = 16000$$

- You only need to set up the A/D conversion curve for once. Set up CR#40 (Set value changing prohibited) to prevent incorrect operations.

2. Adjusted Curve

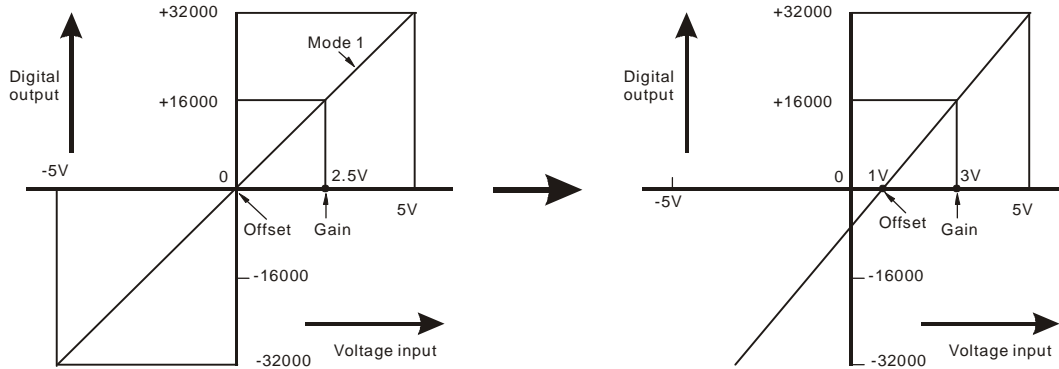

3. Devices

- X0 = On: Set the input mode of the signals in CH2 as mode 1.
- X1 = On: Set Offset value of CH2 as 1V (6,400) and Gain value as 3V (19,200).
- M0 = On: Disable CH2 set value changing.

4. Program explanation

- When X0 = On, set CR#3 as K1 (H'0001) and the signal input mode in CH2 as mode 1 (voltage input mode).
- When X1 = On, write K6,400 (Offset value of CH2) into CR#29 and K19,200 (Gain value of CH2) into CR#35.
- When X1 goes from On to Off, set M0 = On to disable the adjustment on A/D conversion curve. Write K2 (H'2) into CR#40 b1=1 to disable CH2 set value changing.

5. Program example

Ladder diagram:

Explanation:

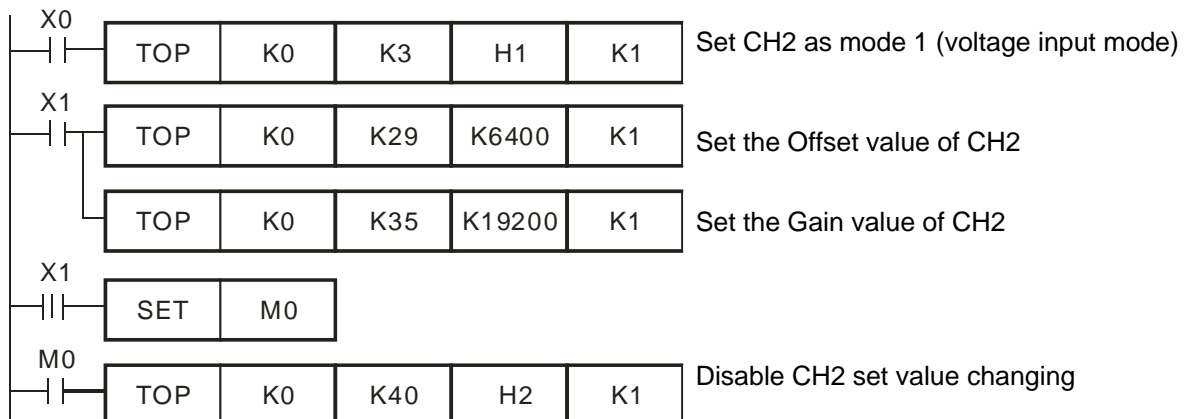

1.7.5 Adjusting A/D Conversion Curve in Current Input Mode 4, Mode 5, and Mode 6

1. Description

- Take 04AD CH3 for example. When CR#4 is set as current input mode (mode 4), the Offset value will be set as 0mA (0) and Gain value as 10mA (10mA/0.625 μ A=16,000), i.e. input current -20mA ~ +20mA will correspond to values -32,000 ~ +32,000.
- When CR#4 is set as current input mode (mode 5), the Offset value will be set as 0mA (0) and Gain value as 10mA (10mA/0.625 μ A=16,000), i.e. input current 0mA ~ +20mA will correspond to values 0 ~ +32,000.
- When CR#4 is set as current input mode (mode 6), the Offset value will be set as 4mA (4mA/0.625 μ A=6,400) and Gain value as 12mA (12mA/0.625 μ A=19,200), i.e. input current 4mA ~ +20mA will correspond to values 0 ~ +32,000.

1 Analog Input Module DVP04AD-E2

- If you cannot use the default current input mode (mode 4 ~ mode 6), you can make adjustments on the A/D conversion curve according to your actual need. For example, set the Offset of CH3 as 8mA (8mA/0.625μA=12,800) and Gain as 14mA (14mA/0.625μA=22,400).

$$Y = \frac{16000 \times \left(\frac{X(mA)}{20(mA)} \times 32000 - Offset \right)}{Gain - Offset}$$

Example: If X=14mA, Y=?

$$Y = \frac{16000 \times \left(\frac{14(mA)}{20(mA)} \times 32000 - 12800 \right)}{(22400 - 12800)} = 16000$$

- You only need to set up the A/D conversion curve for once. Set up CR#40 (Set value changing prohibited) to prevent incorrect operations.

2. Adjusted Curve

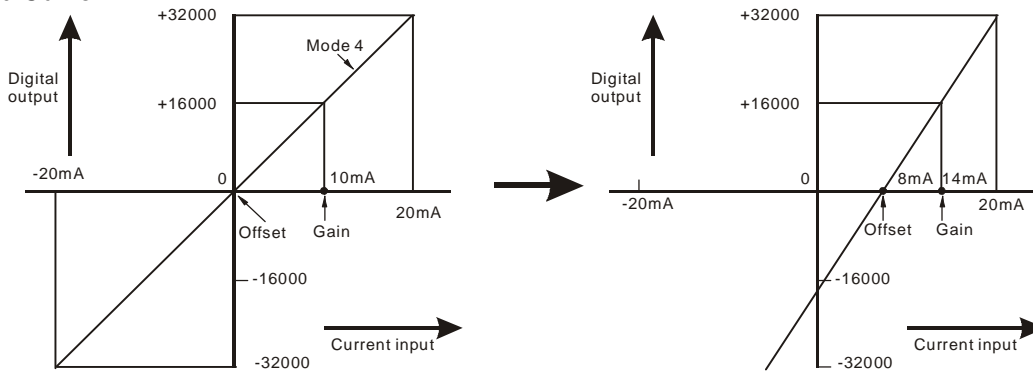

3. Devices

- X0 = On: Set the input mode of the signals in CH3 as mode 4.
- X1 = On: Set Offset value of CH3 as 8mA (12,800) and Gain value as 14mA (22,400).
- M0 = On: Disable CH3 set value changing.

4. Program explanation

- When X0 = On, set CR#4 as K4 (H'4) and the signal input mode in CH3 as mode 4 (current input mode).
- When X1 = On, write K12,800 (Offset value of CH3) into CR#30 and K22,400 (Gain value of CH3) into CR#36.
- When X1 goes from On to Off, set M0 = On to disable the adjustment on A/D conversion curve. Write K4 (H'4) into CR#40 to disable CH3 set value changing.

5. Program example

Ladder Diagram:

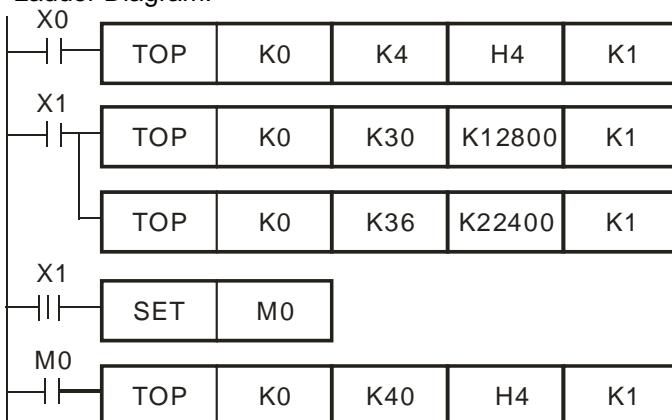

Explanation:

Set CH3 as mode 4 (current input mode)

Set the Offset value of CH3

Set the Gain value of CH3

Disable CH3 set value changing

1.8 Applications

1.8.1 Measuring Current

1. Description

- Assume there is an equipment that requires PLC to convert the external current -20mA ~ 20mA supplied into digital signals and display the value in register D0 for monitoring the current.
- Set the input signals of the A/D module as mode 4, i.e. the current input mode (-20mA ~ +20mA).

2. Devices

- D40: average value of the input signals
- D50: present value of the input signal
- D0: actual value of the present measured current

3. Wiring

- Connect the current signal to be measured to CH1 of DVP04AD-E2 and short-circuit V+ and I+ (as shown below).

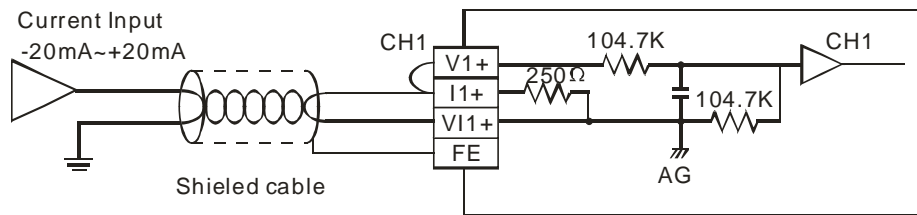

4. Program explanation

- When PLC goes from STOP to RUN, set CH1 as current input mode 4 (-20mA ~ +20mA) (CR#2), and together set the average times of the input signals in CH1 as 10 (CR#8).
- Save the average value of the input signals measured into D40 and the present value of the input signal measured into D50.
- In the current mode of DVP04AD-E2, the value range -20mA ~ 20mA corresponds to K-32,000 ~ K32,000. D50 is 1600 times of the actual current value (i.e. $32,000/20 = 1,600$). Divide the value in D50 by 1,600 and store the value obtained into D0 which will be the actual value of the present measured current.

5. Program example

Ladder diagram:

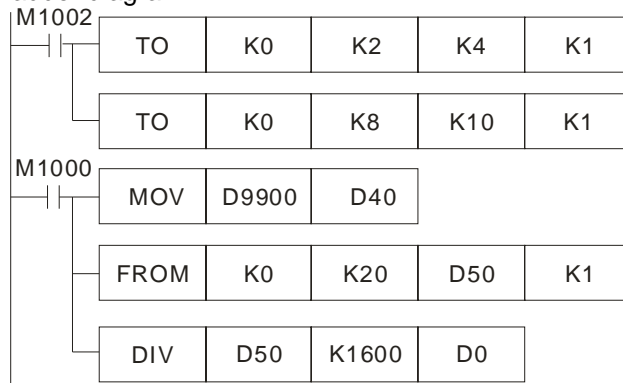

Explanation:

Set CH1 as mode 4 (current input mode)

Set the average times of CH1 as 10

Store the average value of CH1 input signals into D40

Store the present value of CH1 input signal into D50

$D50/1600 = D0$ (the actual value of the present measured current in CH1)

1 Analog Input Module DVP04AD-E2

1.8.2 Measuring the Speed of AC Motor Drive

1. Description

- Assume we set the output frequency of VFD-B as 0 ~ 50.0Hz, which corresponds to the analog 0 ~ 10V DC output supplied by VFD-B, and send it to DVP04AD-E2 to be converted into values. The voltage value will be displayed in register D0.
- After an operation, the voltage value in D0 will become the actual voltage value of VFD-B and the converted frequency will be stored in register D4.
- Set the input signals of A/D module as mode 2, i.e. the voltage input mode (0V ~ +10V).

2. Devices

- D40: average digital value of input signals
- D50: present digital value of input signal
- D0: actual value of the present measured voltage
- D4: actual frequency of VFD-B.

3. Wiring

- Connect the analog voltage output 0 ~ 10V DC offered by VFD-B to CH1 of DVP04AD-E2 (as shown below).

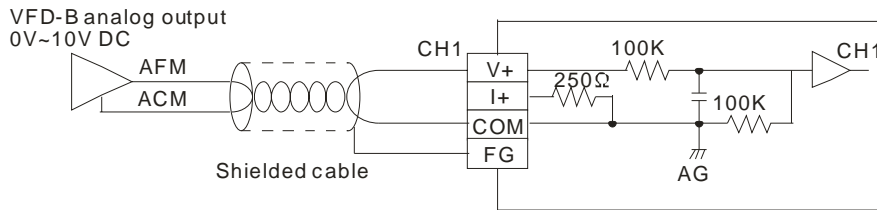

4. Program explanation

- When PLC goes from STOP to RUN, the analog output voltage VFD-B offers is 0 ~ 10V DC. Therefore, set the input mode of DVP04AD-E2 as mode 2, i.e. voltage input mode (0V ~ +10V).
- Save the present value of the input signal measured into D50.
- In the voltage mode of DVP04AD-E2, The value range for 0 ~ 10V DC is K0 ~ K32,000. Data in D50 is 3200 times of the actual voltage value (i.e. $32,000/10V = 3,200$). Divide the value in D50 by 3,200 and store the value obtained into D0 which represents actual voltage measured.
- Frequency range 0 ~ 50.0Hz corresponds to voltage output 0 ~ 10V. Therefore, multiply the value in D0 by 5 ($50/10=5$) and store the value obtained in register D4 for obtaining the actual output frequency of VFD-B.

5. Program example

Ladder diagram:

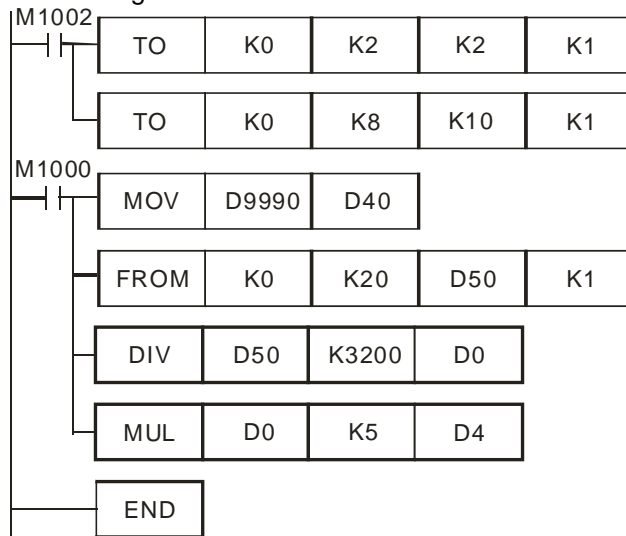

Explanation:

Set as mode 2 (voltage input mode 0~10V)

Set the average times as 10.

Storing the measured average value of input signal into D40.

Store the measured digital value of input signal into D50.

$D50/3200 = D0$ (the actual voltage measured)

$D0*5 = D4$ (the output frequency)

MEMO

2 Analog Output Module DVP02DA-E2/DVP04DA-E2

2.1 The D/A Conversion

In industrial automation, many control signals are analog signals. The most frequently adopted range for the signals are voltage $-10V \sim 10V$ and current $0 \sim 20mA$. Therefore, the data in the PLC have to be converted into analog signals for controlling the peripheral devices.

For example, data $-32,000 \sim 32,000$ in the PLC are converted into voltage $-10V \sim 10V$ by a D/A module. The output voltage can therefore be used for controlling the peripheral analog devices.

2.2 Introduction

DVP02DA-E2 (DVP04DA-E2) analog signal output module receives 2 (4) groups of 16-bit digital data from the PLC MPU and converts the digital data into 2 (4) points analog output signals (voltage or current). You can select voltage output or current output by the wiring. Range for voltage output: $-10V \sim 10V$ ($-32,000 \sim 32,000$). Range for current output: $0 \sim 20mA$ ($0 \sim 32,000$).

2.3 Product Profile and Outline

2.3.1 DVP04DA-E2

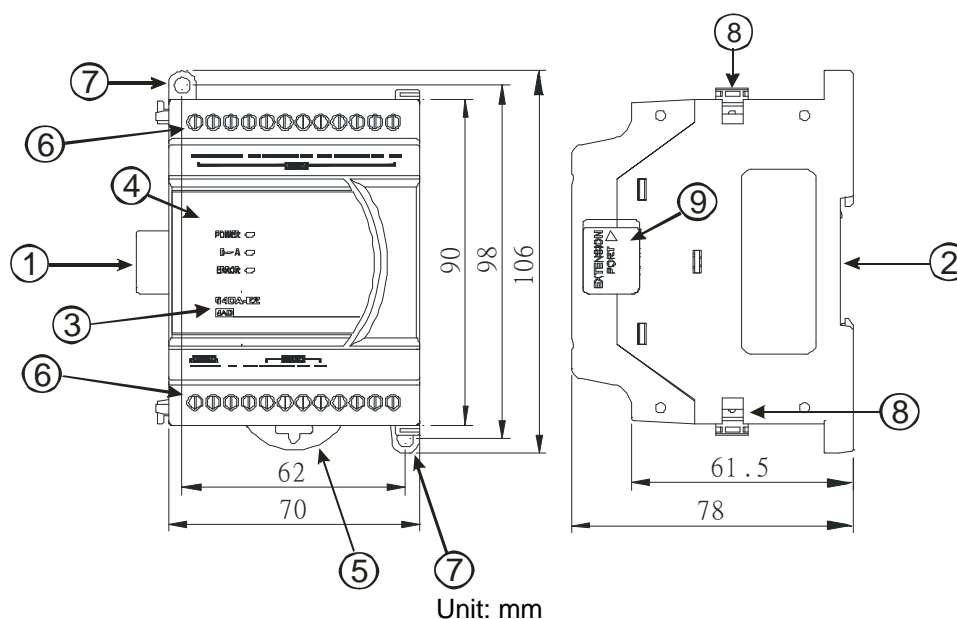

1. Connection port for extension unit/module	6. Terminals
2. DIN rail (35mm)	7. Mounting hole
3. Model name	8. Fixing clip for extension unit/module
4. POWER, ERROR, D→A indicators	9. Mounting port for extension unit/module
5. DIN rail clip	

I/O terminals

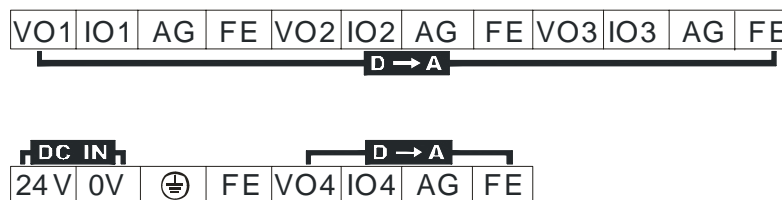

2 Analog Output Module DVP02DA-E2/DVP04DA-E2

2.3.2 DVP02DA-E2

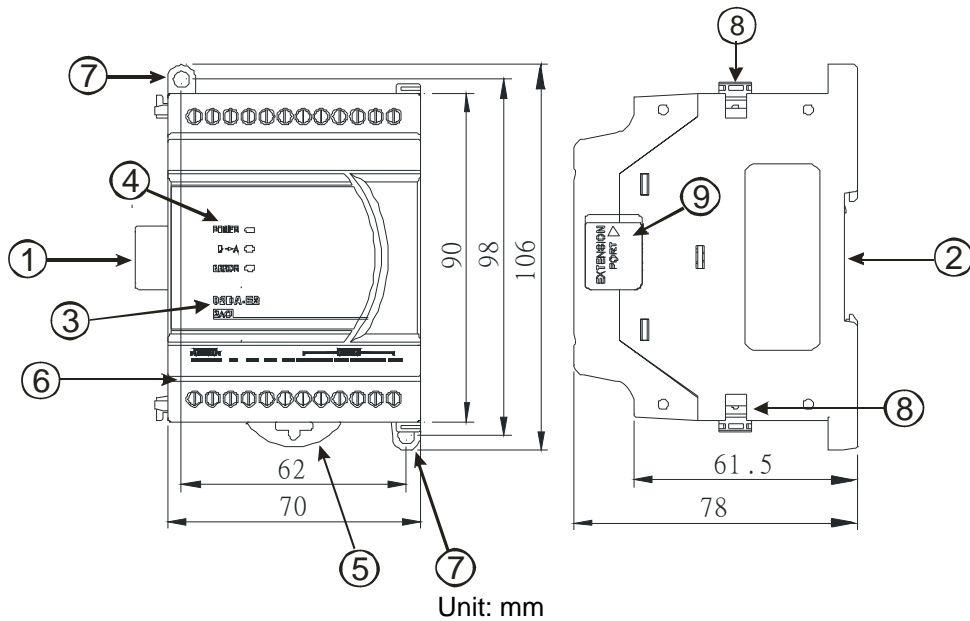

1. Connection port for extension unit/module	6. Terminals
2. DIN rail (35mm)	7. Mounting hole
3. Model name	8. Fixing clip for extension unit/module
4. POWER, ERROR, D→A indicators	9. Mounting port for extension unit/module
5. DIN rail clip	

I/O terminals



2.4 External Wiring

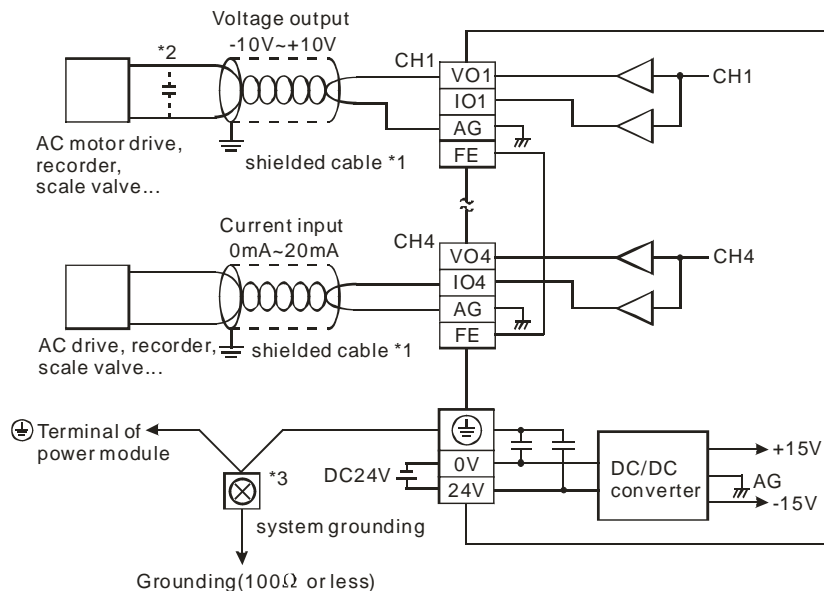

*1: When performing analog output, please isolate other power wirings.

*2: If the ripples at the loaded input terminal are too significant that causes noise interference on the wiring, connect the wiring to 0.1 ~ 0.47μF 25V capacitor.

*3: Please connect the \oplus terminal on both the power modules and DA to the system earth point and ground the system contact or connect it to the cover of power distribution cabinet.

2 Analog Output Module DVP02DA-E2/DVP04DA-E2

2.5 Specifications

DVP02DA-E2/DVP04DA-E2	Voltage output	Current output	
Power supply voltage	24 V DC (20.4 ~ 28.8V DC) (-15% ~ +20%)		
Connector	European standard fixed terminal block (Pin pitch: 5mm)		
Analog output channel	2 channels or 4 channels		
Range of analog output	-10V ~ 10V	0 ~ 20mA	4mA ~ 20mA
Range of digital conversion	-32,000 ~ +32,000	0 ~ +32,000	0 ~ +32,000
Max./Min. input range of digital data	-32,768 ~ +32,767	0 ~ +32,767	-6,400 ~ +32,767
Resolution	14 bits 20V/64000	14 bits 20mA/32000	14 bits 16mA/32000
Output impedance	0.5Ω or lower		
Overall accuracy	±0.5% when in full scale (25°C, 77°F); ±1% when in full scale within the range of (0 ~ 55°C, 32 ~ 131°F)		
Response time	3 ms/ all channels		
Max. output current	20mA (1KΩ ~ 2MΩ)	-	
Tolerance load impedance	-	0 ~ 500Ω	
Digital data format	16 significant bits out of 16 bits are available; in 2's complement		
Isolation	Optical coupler isolation between analog circuits and digital circuits. No isolation among analog channels. 500VDC between digital circuits and Ground 500VDC between analog circuits and Ground 500VDC between analog circuits and digital circuits 500VDC between 24VDC and Ground		
Protection	Voltage output is protected by short circuit. Short circuit lasting for too long may cause damage on internal circuits. Current output can be open circuit.		
Series connection to DVP-PLC MPU	The modules are numbered from 0 to 7 automatically by their distance from MPU. Maximum 8 modules are allowed to connect to MPU and will not occupy any digital I/O points.		
D/A conversion curve (Default: mode 0)	Mode 0 (H'0000): (-10V ~ +10V) 		Mode 1 (H'0001): (0mA ~ +20mA)
	Mode 2 (H'0002): (+4mA ~ +20 mA) 		Mode -1 (H'FFFF): Channel unavailable. The channel is disabled. Output voltage = 0; output current = 0.
	Operation/storage 1. Operation: 0°C ~ 55°C (temperature), 50 ~ 95% (humidity); pollution degree 2 2. Storage: -25°C ~ 70°C (temperature), 5 ~ 95% (humidity)		
	Vibration/shock immunity International standards: IEC61131-2, IEC 68-2-6 (TEST Fc) / IEC61131-2 & IEC 68-2-27 (TEST Ea)		
Power Supply			
Max. rated power consumption	24V DC (20.4 ~ 28.8V DC) (-15% ~ +20%), 3W, supplied by external power source.		

2 Analog Output Module DVP02DA-E2/DVP04DA-E2

2.6 CR (Control Register)

2.6.1 CR in DVP02DA-E2 / DVP04DA-E2

DVP02DA-E2 / DVP04DA-E2				Description
CR#	Attrib.		Register content	
#0	YES	R	Model name	Set up by the system: DVP02DA-E2 model code = H'0041 DVP04DA-E2 model code = H'0081
#1	YES	R	Firmware version	Display the current firmware version in hex.
#2	YES	R/W	CH1 output mode setting	Output mode: Default = H'0000. Take CH1 for example: Mode 0 (H'0000): Voltage output (-10V ~ +10V). Mode 1 (H'0001): Current output (0mA ~ +20mA). Mode 2 (H'0002): Current output (4mA ~ +20mA). Mode -1 (H'FFFF): Channel 1 unavailable
#3	YES	R/W	CH2 output mode setting	
#4	YES	R/W	CH3 output mode setting	
#5	YES	R/W	CH4 output mode setting	
#6 ~ #27	Reserved			
#28	YES	R/W	Adjusted Offset value of CH1	Set the adjusted Offset value of CH1 ~ CH4. Default = K0 Definition of Offset in DVP02/04DA-E2: The corresponding voltage (current) output value when the digital input value = 0.
#29	YES	R/W	Adjusted Offset value of CH2	
#30	YES	R/W	Adjusted Offset value of CH3	
#31	YES	R/W	Adjusted Offset value of CH4	
#32 ~ #33	Reserved			
#34	YES	R/W	Adjusted Gain value of CH1	Set the adjusted Gain value of CH1 ~ CH4. Default = K16,000 Definition of Gain in DVP02/04DA-E2: The corresponding voltage (current) output value when the digital input value = 16,000
#35	YES	R/W	Adjusted Gain value of CH2	
#36	YES	R/W	Adjusted Gain value of CH3	
#37	YES	R/W	Adjusted Gain value of CH4	
#38 ~ #39	Reserved			
#40	YES	R/W	Function: Set value changing prohibited	Prohibit set value changing in CH1 ~ CH4
#41	NO	R/W	Function: Save all the set values	Save all the set values, Default =H'0000
#42	NO	R/W	Function: Return to default setting	Set all values to default setting, Default = H'0000
#43	NO	R	Error status	Register for storing all error status. Refer to table of error status for more information.
#44 ~ #99	Reserved			
#100	YES	R/W	Function: Enable/Disable limit detection	Enable/Disable the upper and lower bound detection function
#101	NO	R/W	Upper and lower bound status	Display the upper and lower bound value, Default =H'0000
#102	YES	R/W	Set value of CH1 upper bound	Set value of CH1~CH4 upper bound
#103	YES	R/W	Set value of CH2 upper bound	
#104	YES	R/W	Set value of CH3 upper bound	
#105	YES	R/W	Set value of CH4 upper bound	
#106 ~ #107	Reserved			
#108	YES	R/W	Set value of CH1 lower bound	Set value of CH1~CH4 lower bound. Default = K-32,000
#109	YES	R/W	Set value of CH2 lower bound	
#110	YES	R/W	Set value of CH3 lower bound	
#111	YES	R/W	Set value of CH4 lower bound	
#112 ~ #113	Reserved			
#114	YES	R/W	Output update time of CH1	Set output update time of CH1 ~ CH4
#115	YES	R/W	Output update time of CH2	
#116	YES	R/W	Output update time of CH3	
#117	YES	R/W	Output update time of CH4	
#118	YES	R/W	LV output mode setting	
Symbols: YES: When CR#41 is set to H'5678, the set value of CR will be saved. NO: Set value will not be saved R: Able to read data by FROM instruction, W: Able to write data by using TO instructions For voltage output mode0: 0.3125mV = 20V/64,000. For current output mode1: 0.625 μ A = 20mA/32,000 For current output mode2: 0.5 μ A = 16mA/32,000				

2.6.2 Explanation on CR

CR#0: Model name

[Explanation]

1. DVP02DA-E2 model code = H'0041
2. DVP04DA-E2 model code = H'0081

3. You can read the model name in the program to see if the extension module exists.

CR#1: Firmware version

[Explanation]

Display the current firmware version in hex, e.g. version V1.00 is indicated as H'0100.

CR#2, 3, 4, 5: CH1 ~ CH4 output mode setting

[Explanation]

Set the working mode of the channels in the analog output module. There are 4 modes for each channel which can be set up separately.

When you set CH1 as mode 1 (H'0001) CR#2 has to be set as H'0001. The default setting = H'0000. Take CH1 as example:

Mode 0 (H'0000): Voltage output (-10V ~ +10V).

Mode 1 (H'0001): Current output (0mA ~ 20mA).

Mode 2 (H'0002): Current output (4mA ~ 20mA).

Mode -1 (H'FFFF): CH1 unavailable.

CR#28, 29, 30, 31: Adjusted Offset value of CH1 ~ CH4

[Explanation]

1. Set the adjusted Offset value of CH1 ~ CH4, which represents the corresponding voltage (current) output value when the digital input value = 0
2. Default setting = K0.

CR#34, 35, 36, 37: Adjusted Gain value of CH1 ~ CH4

[Explanation]

1. Set the adjusted Gain value of CH1 ~ CH4, which represents the corresponding voltage (current) output value when the digital input value = 16,000.
2. Default setting = K16,000.

CR#40: Function: Set value changing prohibited, Default = H'0000

[Explanation]

Description	
bit0	b0=0, CH1 changing allowed; b0=1, CH1 changing prohibited
bit1	b1=0, CH2 changing allowed; b1=1, CH2 changing prohibited
bit2	b2=0, CH3 changing allowed; b2=1, CH3 changing prohibited
bit3	b3=0, CH4 changing allowed; b3=1, CH4 changing prohibited
bit4 ~ bit15	Reserved

Relative	
CR#2 ~ CR#5	Output mode setting of CH1 ~ CH4
CR#28 ~ CR#31	Adjusted Offset value of CH1 ~ CH4
CR#34 ~ CR#37	Adjusted Gain value of CH1 ~ CH4
CR#42	Return to default setting
CR#100	Function: Enable/Disable limit detection
CR#102~CR#105	Set value of CH1~CH4 upper bound
CR#108~CR#111	Set value of CH1~CH4 lower bound
CR#114~CR#117	Output update time of CH1 ~ CH4
CR#118	LV output mode setting

CR#41: Save all the set values, Default =H'0000

[Explanation]

Save function setting. Save all the set values to the internal flash memory. When saving is completed, CR#41 will be set to H'FFFF.

Set value	Function
H0	No action
HFFFF	Saving completed
H5678	Saving enabled.

2 Analog Output Module DVP02DA-E2/DVP04DA-E2

Note: Default setting = H'0. When set value = H'5678, saving will be enabled, and CR#41 will be set to H'FFFF when saving is completed. If the set value is not H'5678, the set value will remain H'0. For example, input K1 into CR#41, and the value will remain H'0.

CR#42: Function: Return to default setting. Default =H'0000

[Explanation]

Description	
bit0	b0=0, no action on CH1; b0=1, set CH1 to default setting
bit1	b1=0, no action on CH2; b1=1, set CH2 to default setting
bit2	b2=0, no action on CH3; b2=1, set CH3 to default setting
bit3	b3=0, no action on CH4; b3=1, set CH4 to default setting
bit4 ~ bit15	Reserved

Note: Set designated bit as 1 and the corresponding channel will be Return to default setting. When setting is completed, the value will be set to 0. If CR#40(Set value changing prohibited) is enabled, the default setting in CR#42 will be invalid, and all set values will remain unchanged. Error Code bit 12 of CR#43 will be set to 1.

Relative Parameters	
CR#2 ~ CR#5	Output mode setting of CH1 ~ CH4
CR#28 ~ CR#31	Adjusted Offset value of CH1 ~ CH4
CR#34 ~ CR#37	Adjusted Gain value of CH1 ~ CH4
CR#100	Function: Enable/Disable limit detection
CR#102~CR#105	Set value of CH1~CH4 upper bound
CR#108~CR#111	Set value of CH1~CH4 lower bound
CR#114~CR#117	Output update time of CH1 ~ CH4
CR#118	LV output mode setting

CR#43: Error Status. Default=H'0000

[Explanation]

CR#43: error status value. See the table below:

Description		
bit0	K1 (H'1)	Power supply error
bit1	K2 (H'2)	Hardware error
bit2	K4 (H'4)	Upper / lower bound error
bit3 ~ bit8		Reserved
bit9	K512(H'0200)	Mode setting error
bit10		Reserved
bit11	K2048(H'0800)	Upper / lower bound setting error
bit12	K4096(H'1000)	Set value changing prohibited
Bit13	K8192(H'2000)	Communication breakdown on next module
bit14 ~ bit15		Reserved

 **Note:** Each error status is determined by the corresponding bit (b0 ~ b13) and there may be more than 2 errors occurring at the same time. 0 = normal; 1 = error

CR#100: Function: Enable/Disable limit detection

[Explanation]

Description	
bit0=1	Enable CH1 limit detection
bit1=1	Enable CH2 limit detection
bit2=1	Enable CH3 limit detection
bit3=1	Enable CH4 limit detection
bit4 ~ bit7	Reserved
bit8=1	Enable upper/lower bound limitation function on CH1
bit9=1	Enable upper/lower bound limitation function on CH2
bit10=1	Enable upper/lower bound limitation function on CH3
bit11=1	Enable upper/lower bound limitation function on CH4
bit12 ~ bit15	Reserved

CR#101: Upper and lower bound status

[Explanation]

Description	
bit0=1	CH1 exceeds lower bound
bit1=1	CH2 exceeds lower bound
bit2=1	CH3 exceeds lower bound
bit3=1	CH4 exceeds lower bound
bit4 ~ bit7	Reserved
bit8=1	CH1 exceeds upper bound
bit9=1	CH2 exceeds upper bound
bit10=1	CH3 exceeds upper bound
bit11=1	CH4 exceeds upper bound
bit12 ~ bit15	Reserved

CR#102, 103, 104, 105: Set value of CH1 ~ CH4 upper bound

[Explanation]

Set the upper bound value of CH1 ~ CH4. Default: K32,000

CR#108, 109, 110, 111: Set value of CH1 ~ CH4 lower bound

[Explanation]

Set the lower bound value of CH1 ~ CH4. Default: K-32,000

CR#114, 115, 116, 117: Output update time of CH1 ~ CH4

[Explanation]

Unit: 100ms

Range	Default
1~100 (0.1s~10s)	0(unavailable)

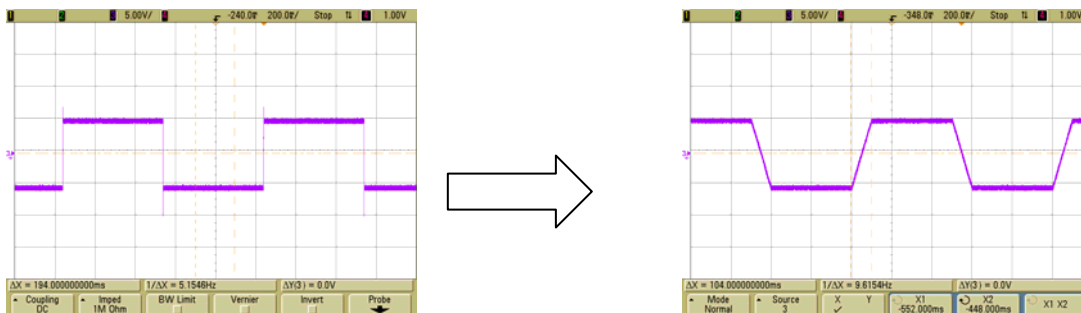

CR#118: LV output mode setting of CH1 ~ CH4. Default=0

[Explanation]

CR[118]=0: When the power is at LV (low voltage) condition, the output performs natural discharge.

CR[118]=1: When the power is at LV condition, set the output value as 0. See the curve below:

CR[118]=0

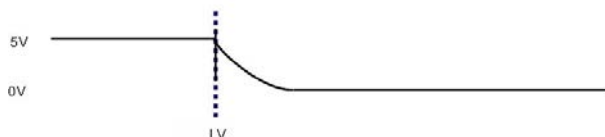

CR[118]=1

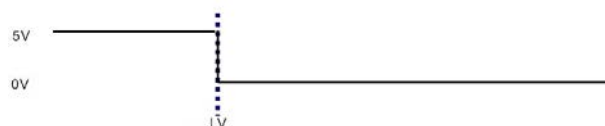

2 Analog Output Module DVP02DA-E2/DVP04DA-E2

2.6.3 Explanation on Special Registers D9900~D9999

When ES2 MPU is connected with modules, registers D9900~D9999 will be reserved for storing values from modules. You can apply MOV instruction to operate values in D9900~D9999.

When ES2 MPU is connected with DVP04AD-E2, the configuration of special registers is as below:

Module#0	Module #1	Module #2	Module #3	Module #4	Module #5	Module #6	Module #7	Description
D1320	D1321	D1322	D1323	D1324	D1325	D1326	D1327	Model Code
D9900	D9910	D9920	D9930	D9940	D9950	D9960	D9970	CH1 output value
D9901	D9911	D9921	D9931	D9941	D9951	D9961	D9971	CH2 output value
D9902	D9912	D9922	D9932	D9942	D9952	D9962	D9972	CH3 output value
D9903	D9913	D9923	D9933	D9943	D9953	D9963	D9973	CH4 output value

1. Example

Ladder diagram:

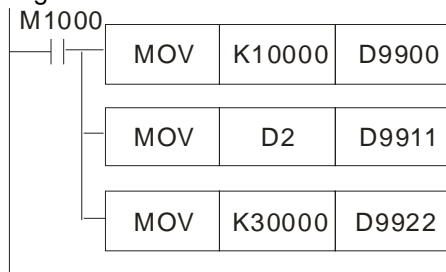

Explanation:

Set CH1 output value of Module#0 as K10000

Set CH2 output value of Module#1 as D2

Set CH3 output value of Module#2 as K30000

2.7 D/A Conversion Curve

You can adjust the conversion curves according to the actual needs by changing the Offset value (CR#28 ~ CR#31) and Gain value (CR#34 ~ CR#37).

Gain (in DVP02/04DA-E2): The corresponding voltage (current) output value when the digital input value = 16,000.

Offset (in DVP02/04DA-E2): The corresponding voltage (current) output value when the digital input value = 0.

- For voltage output Mode 0: $0.3125\text{mV} = 20\text{V}/64,000$

Equation:

$$Y(V) = \left[\frac{X \times (\text{Gain} - \text{Offset})}{16000} + \text{Offset} \right] \times \left(\frac{10(V)}{32000} \right)$$

Y= Voltage output, X= Digital input

- For current output Mode 1: $0.625\mu\text{A} = 20\text{mA}/32,000$

Equation:

$$Y(\text{mA}) = \left[\frac{X \times (\text{Gain} - \text{Offset})}{16000} + \text{Offset} \right] \times \left(\frac{20(\text{mA})}{32000} \right)$$

Y= Current output, X= Digital input

- For current output Mode 2: $0.5\mu\text{A} = 16\text{mA}/32,000$

Adopt the equation of current output mode 1, substitute Gain for 19,200(12mA) and Offset for 6,400(4mA)

Equation:

$$Y(\text{mA}) = \left[\frac{X \times (19200 - 6400)}{16000} + 6400 \right] \times \left(\frac{20(\text{mA})}{32000} \right)$$

Y= Current output, X= Digital input

2.7.1 Voltage Output Mode

- Mode 0 (H'0000): (-10V ~ +10V)

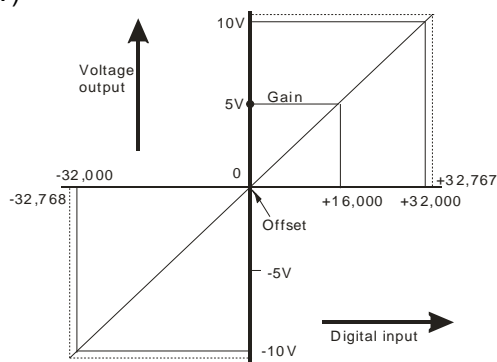

Mode 0 of CR#2~ CR#5	-10V ~ +10V, Gain = 5V (16,000), Offset = 0V (0).
Gain (CR#28 ~ CR#31)	The corresponding voltage output value when the digital input value = 16,000.
Offset (CR#34 ~ CR#37)	The corresponding voltage output value when the digital input value = 0.
Range of digital conversion	-32,000 ~ +32,000
Max./Min. input range of digital data	-32,768 ~ +32,767

2.7.2 Current Output Mode

- Mode 1 (H'0001): (0mA ~ +20mA)

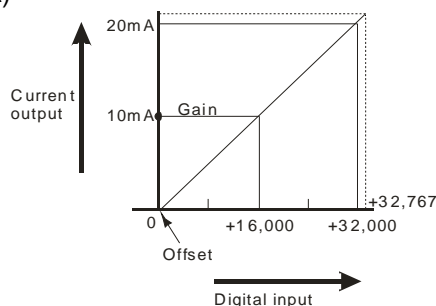

Mode 1 of CR#2~ CR#5	0mA ~ +20mA, Gain = 10mA (16,000), Offset = 0mA (0).
Gain (CR#28 ~ CR#31)	The corresponding current output value when the digital input value = 16,000.
Offset (CR#34 ~ CR#37)	The corresponding current output value when the digital input value = 0.
Range of digital conversion	0 ~ +32,000
Max./Min. range of digital data	0 ~ +32,767

2 Analog Output Module DVP02DA-E2/DVP04DA-E2

- Mode 2 (H'0002): (4mA ~ +20mA)

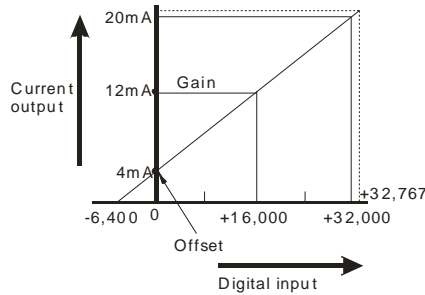

Mode 2 of CR#2~ CR#5	4mA ~ +20mA, Gain = 12mA (19,200), Offset = 4mA (6,400).
Gain (CR#28 ~ CR#31)	The corresponding current output value when the digital input value = 19,200.
Offset (CR#34 ~ CR#37)	The corresponding current output value when the digital input value = 6,400.
Range of digital conversion	0 ~ +32,000
Max./Min. input range of digital data	-6400 ~ +32,767

2.7.3 Adjusting D/A Conversion Curve in Voltage Output Mode

1. Description

- Take 04DA CH1 for example, when CR#2 is set as voltage output mode (mode 0), the Offset value will be set as 0V (0) and Gain value as 5V (5V/0.3215mV=16,000), i.e. output voltage -10V ~ 10V will correspond to values -32,000 ~ +32,000.
- If you cannot use the default voltage output mode (mode 0), you can make adjustments on the D/A conversion curve according to your actual needs. For example, set the Offset of CH1 as 2V (2V/0.3215mV=6,400) and Gain as 6V (6V/0.3215mV=19,200).

$$Y(V) = \left[\frac{X \times (Gain - Offset)}{16000} + Offset \right] \times \left(\frac{10(V)}{32000} \right)$$

Example: If X=16000, Y=?

$$Y(V) = \left[\frac{16000 \times (19200 - 6400)}{16000} + 6400 \right] \times \left(\frac{10(V)}{32000} \right) = 6(V)$$

- You only need to set up the D/A conversion curve for once. Set up CR#40 (Set value changing prohibited) to prevent incorrect operations.

2. Adjusted Curve

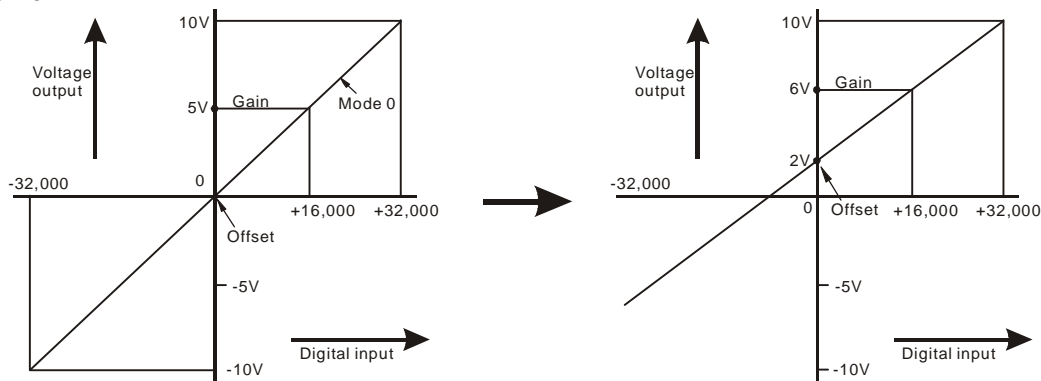

3. Devices

- X0 = On: Set the output mode of CH1 as mode 0.
- X1 = On: Set Offset value of CH1 as 2V (6,400) and Gain value as 6V (19,200).
- M0 = On: Disable CH1 set value changing.

4. Program explanation

- When X0 = On, set CR#2 as K0 (H'0000) and the signal output mode at CH1 as mode 0 (voltage output mode).
- When X1 = On, write K6,400 (Offset value of CH1) into CR#28 and K19,200 (Gain value of CH1) into CR#34.

- When X1 goes from On to Off, set M0 = On to disable the adjustment on D/A conversion curve. Write K1 (H'1) into CR#40 b0=1 to disable CH1 set value changing.

5. Program example

Ladder diagram:

Explanation:

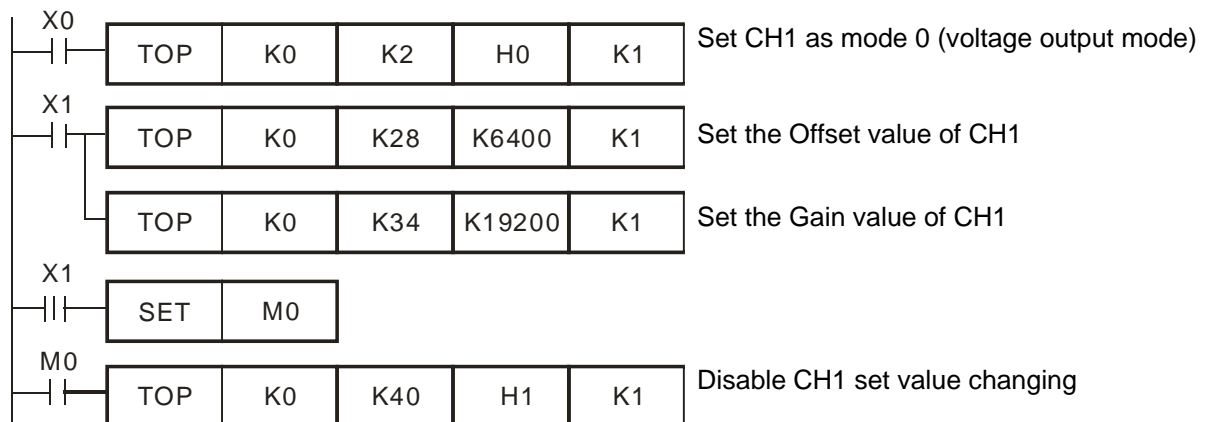

2.7.4 Adjusting D/A Conversion Curve in Current Output Mode 1 and Mode 2

1. Description

- Take 04DA CH1 for example, when CR#2 is set as current output mode (mode 1), the Offset value will be set as 0mA (0) and Gain value as 10mA (10mA/0.625μA=16,000), i.e. output current 0mA ~ +20mA will correspond to values 0 ~ +32,000.
- When CR#2 is set as current output mode (mode 2), the Offset value will be set as 4mA (4mA/0.625μA=6,400) and Gain value as 12mA (12mA/0.625μA=19,200), i.e. input current 4mA ~ +20mA will correspond to values 0 ~ +32,000.
- If you cannot use the default current output mode (mode 1 and mode 2), you can make adjustments on the D/A conversion curve according to your actual needs. For example, set the Offset of CH1 as 6mA (6mA/0.625μA=9,600) and Gain as 13mA (13mA/0.625μA=20,800).

$$Y(mA) = \left[\frac{X \times (Gain - Offset)}{16000} + Offset \right] \times \left(\frac{20(mA)}{32000} \right)$$

Example: If X=16000, Y=?

$$Y(mA) = \left[\frac{16000 \times (20800 - 9600)}{16000} + 9600 \right] \times \left(\frac{20(mA)}{32000} \right) = 13(mA)$$

- You only need to set up the D/A conversion curve for once. Set up CR#40 (Set value changing prohibited) to prevent incorrect operations.

2. Adjusted Curve

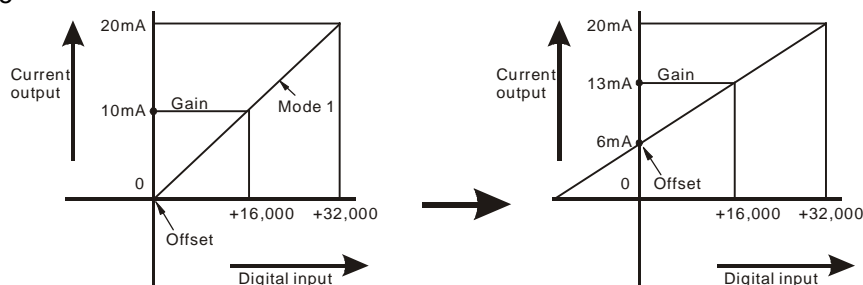

3. Devices

- X0 = On: Set the output mode of the signals at CH1 as mode 1.
- X1 = On: Set Offset value of CH1 as 6mA (9,600) and Gain value as 13mA (20,800).
- M0 = On: Disable CH1 set value changing.

4. Program explanation

- When X0 = On, set CR#2 as K1 (H'0001) and the signal output mode at CH1 as mode 1 (current output mode).
- When X1 = On, write K9,600 (Offset value of CH1) into CR#28 and K20,800 (Gain value of CH1) into CR#34.
- When X1 goes from On to Off, set M0 = On to disable the adjustment on D/A conversion curve. Write K1 (H'1) into CR#40 b0=1 to disable CH1 set value changing.

2 Analog Output Module DVP02DA-E2/DVP04DA-E2

5. Program example

Ladder diagram:



Explanation:

Set CH1 as mode 1 (current output mode)

Set the Offset value of CH1

Set the Gain value of CH1

Disable CH1 set value changing

2.8 Applications

2.8.1 Analog Current Output

1. Explanation

- Assume there is an equipment that requires PLC to convert the digital signals into current 0mA ~ 20mA for controlling the equipment through its analog terminals.
- Set the output signals of the D/A module as mode 1, i.e. the current output mode (0mA ~ 20mA)

2. Devices

- D0: target current output value of CH1
- D40: digital value converted corresponding to the target output current of CH1

3. Wiring

- Connect the analog input terminal on the equipment to CH1 of DVP04DA-E2 (as shown below).

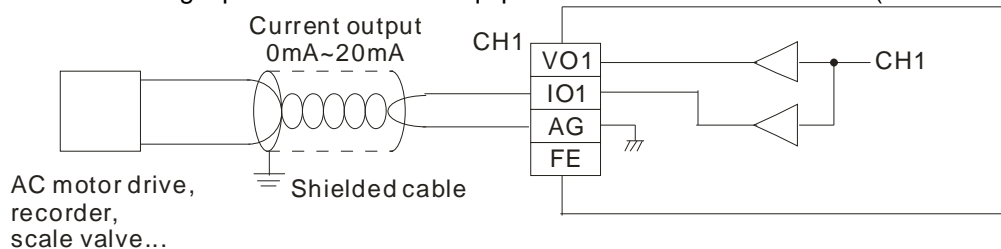

4. Program explanation

- When PLC goes from STOP to RUN, set CH1 as current output mode 1(0mA ~ 20mA)
- In the current output mode 1, the value range 0 ~ 20mA corresponds to K0 ~ K32,000. D0 is the target current output value of CH1, which should be multiplied with 1600 (i.e. $20/32,000 = 1/1,600$) to obtain the digital output value. Multiply the value in D0 with 1,600 and store the value obtained into data register D40 for DVP04DA-E2 to convert the digital value into analog current output.

5. Example program

Ladder diagram:

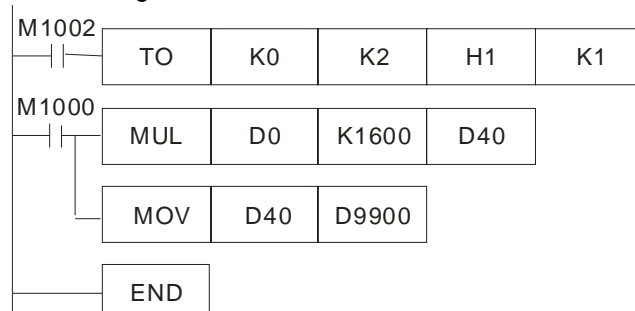

Explanation:

Set CH1 as mode 1 (current output mode)

D0 is the target current output value of CH1

D40 is the corresponding digital value of target output current specified in D0

2.8.2 Controlling the Speed of AC Motor Drive

1. Description

- VFD-B series AC motor drive offers analog input terminal AUI/ACM for accepting external analog voltage -10V ~ 10V to control the FWD/REV frequency -50Hz ~ 50Hz of VFD-B. Therefore, you can use DVP04DA-E2 for controlling the speed of the AC motor drive.
- Set the output signals of D/A module as mode 0, i.e. the voltage output mode (-10V ~ 10V).

2. Devices

- D0: the target frequency of VFD-B (FWD/REV frequency -50Hz ~ 50Hz).
- D40: the corresponding digital value of target output voltage at CH1

3. Wiring

- Connect the analog input terminal AUI/ACM on VFD-B to CH1 of DVP04DA-E2 (as shown below).

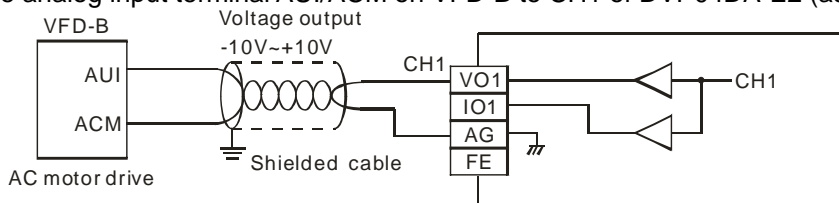

4. Program explanation

- When PLC goes from STOP to RUN, set CH1 as voltage output mode (mode 0).
- In the voltage mode of DVP04DA-E2, the value range -10V ~ 10V corresponds to K-32000 ~ K32,000. D0 is the target frequency for VFD-B (FWD/REV frequency -50Hz ~ 50Hz), which should be multiplied with 640 (i.e. $50/32,000 = 1/640$) to obtain the digital output value. Multiply the value in D0 with 640 and store the value obtained into D40 for DVP04DA-E2 to convert the digital value into voltage output, so as to control the frequency of VFD-B

5. Program example

Ladder diagram:

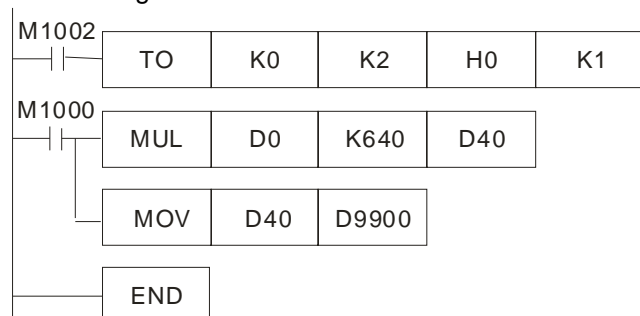

Explanation:

Set as mode 0 (voltage output mode)

D0 = the target frequency of VFD-B (REV / FWD frequency -50Hz ~ 50Hz). Store the operational result into D40.

D40 is the corresponding digital value of target frequency specified in D0.

MEMO

3 Mixed Analog Input/Output Module DVP06XA-E2

3.1 The A/D and D/A Conversion

In industrial automation, many measuring units are transmitted by analog signals. The most frequently adopted range for the signals are voltage -10 ~ +10V and current -20 ~ +20mA. To use the analog signals as the parameters for PLC operations, you have to convert them into digital values first. Furthermore, many control signals are analog signals. The most frequently adopted range for the signals are voltage -10V ~ +10V and current 0 ~ 20mA. Therefore, the data in the PLC have to be converted into analog signals for controlling the peripheral devices.

For example, the voltage -10 ~ 10V is first converted into values -32,000 ~ +32,000 by an XA module, and the PLC will read/write the control registers (CR) in the XA module. The signals sent back to the PLC for operations will be digital K-32,000 ~ K32,000. In addition, data -32,000 ~ +32,000 in the PLC are converted into voltage -10V ~ +10V by an XA module. The output voltage can therefore be used for controlling the peripheral analog devices.

3.2 Introduction

The data in DVP06XA-E2 mixed analog input/output module receives external 4 points of analog input signals (voltage or current) and converts them into 16-bit digital signals. For the analog signal output, DVP06XA-E2 receives 2 groups of 16-bit digital data coming from the PLC MPU and converts the digital data into 2 points of analog output signals (voltage or current). The MPU can read/write the data in the module by using FROM/TO instructions or D9900~D9999 in the program.

For the analog signal input, you can select voltage input or current input by the wiring. Range for voltage input: ±10V (±32,000). Range for current input: ±20mA (±32,000).

For the analog signal output, you can select voltage output or current output by the wiring. Range for voltage output: ±10V (±32,000). Range for current output: 0mA ~ 20mA (0 ~ +32,000).

3.3 Product Profile and Outline

3.3.1 DVP06XA-ES2

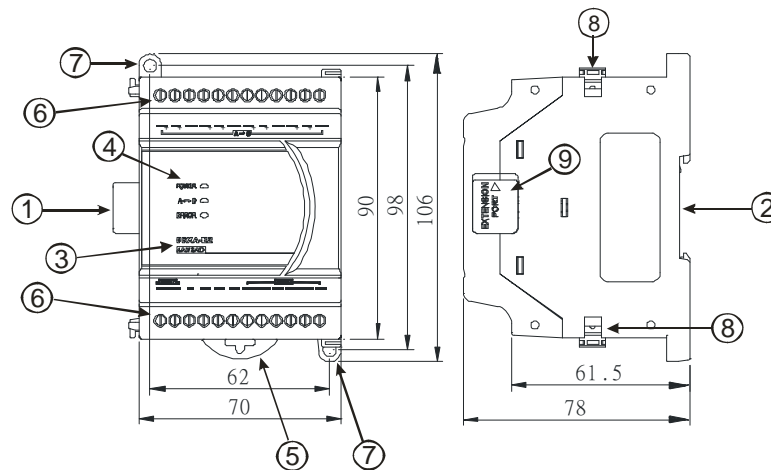

Unit: mm

1. Connection port for extension unit/module	6. Terminals
2. DIN rail (35mm)	7. Mounting hole
3. Model name	8. Fixing clip for extension unit/module
4. POWER, ERROR, A↔D indicators	9. Mounting port for extension unit/module
5. DIN rail clip	

I/O terminals

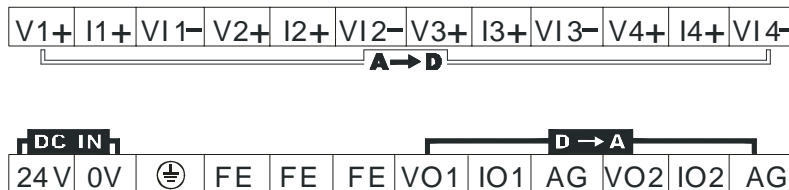

3 Mixed Analog Input/Output Module DVP06XA-E2

3.4 External Wiring

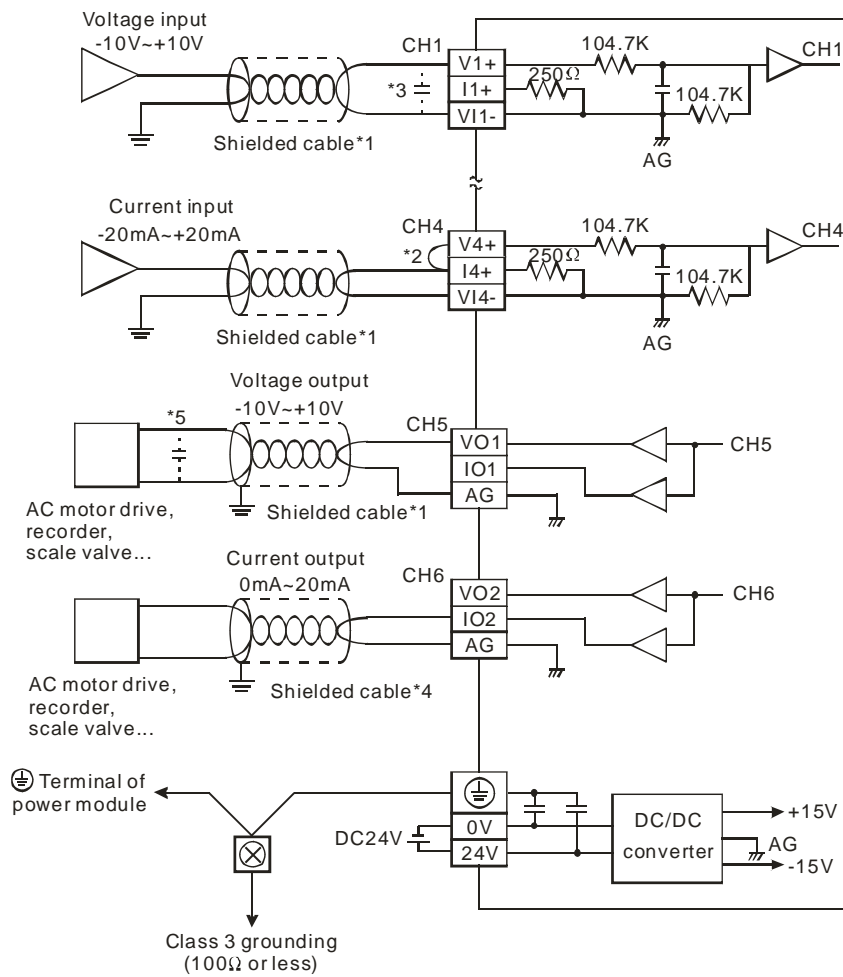

- *1: When performing analog input, please isolate other power wirings.
- *2: When the XA module is connected to current signals, make sure you short-circuit "V+" and "I+" terminals.
- *3: If the ripples at the loaded input terminal are too significant that causes noise interference on the wiring, connect the wiring to 0.1 ~ 0.47μF 25V capacitor.
- *4: When performing analog output, please isolate other power wirings.
- *5: If the ripples at the loaded output terminal are too significant that causes noise interference on the wiring, connect the wiring to 0.1 ~ 0.47μF 25V capacitor.
- *6: Please connect the \oplus terminal on both the power module and XA module to the system earth point and ground the system contact or connect it to the cover of power distribution cabinet.

3 Mixed Analog Input/Output Module DVP06XA-E2

3.5 Specifications

DVP06XA-E2					
Analog/Digital (A/D)	Voltage input			Current input	
Power supply voltage	24 VDC (20.4VDC ~ 28.8VDC) (-15% ~ +20%)				
Connector	European standard fixed terminal block (Pin pitch: 5mm)				
Analog input channel	4 channels				
Range of analog input	±10V	±5V	±20mA	0~20mA	4~20mA
Range of digital conversion	±32,000	±32,000	±32,000	0~32,000	0~32,000
Max./Min. output range of digital data	±32,384	±32,384	±32,384	-384~+32,384	-384~+32,384
Resolution	14 bits 20V/64000	14 bits 10V/64000	14 bits 40mA/64000	13 bits 20mA/32000	13 bits 16mA/32000
Input impedance	> 200 KΩ		250Ω		
Overall accuracy	±0.5% when in full scale (25°C, 77°F) ±1% when in full scale within the range of 0 ~ 55°C (32 ~ 131°F)				
Response time	3 ms / all channels				
Isolation	Optical coupler isolation between digital circuits and analog circuits. No isolation among analog channels. 500VDC between digital circuits and Ground 500VDC between analog circuits and Ground 500VDC between analog circuits and digital circuits 500VDC between 24VDC and Ground				
Range of absolute input	±15V		±32mA		
Digital data format	16 significant bits out of 16 bits are available; in 2's complement				
Average Function	Supported. Available for setting up average times in CR#8 ~ CR#11. Range: K1 ~ K100.				
Self-diagnosis	Upper and lower bound detection in all channels				
Series connection to DVP-PLC MPU	The modules are numbered from 0 to 7 automatically by their distance from MPU. Max. 8 modules are allowed to connect to MPU and will not occupy any digital I/O points.				
A/D conversion curve (Default: mode 0)	Mode 0 (H'0000): (-10V ~ +10V)		Mode 1 (H'0001): (-5V ~ +5V)		
	Mode 2 (H'0002): (0V~+10V)		Mode 3 (H'0003): (0V~+5V)		

3 Mixed Analog Input/Output Module DVP06XA-E2

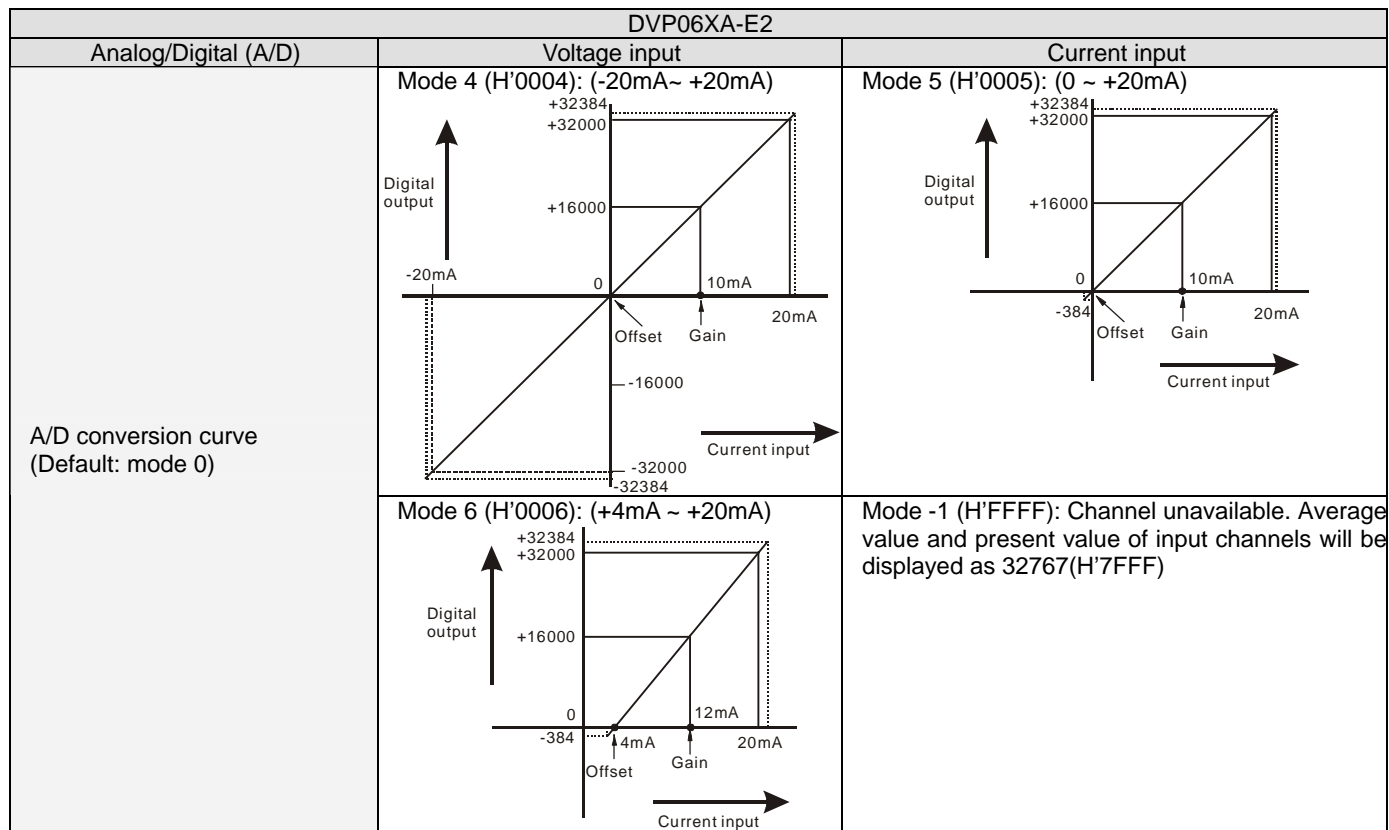

Digital/Analog (D/A)	Voltage output	Current output	
Analog output channel	2 channels		
Range of analog output	-10V ~ 10V	0 ~ 20mA	4mA ~ 20mA
Range of digital conversion	-32,000 ~ +32,000	0 ~ +32,000	0 ~ +32,000
Max./Min. input range of digital data	-32,768 ~ +32,767	0 ~ +32,767	-6,400 ~ +32,767
Resolution	14 bits 20V/64000	14 bits 20mA/32000	14 bits 16mA/32000
Output impedance	0.5Ω or lower		
Overall accuracy	±0.5% when in full scale (25°C, 77°F); ±1% when in full scale within the range of (0 ~ 55°C, 32 ~ 131°F)		
Response time	3 ms/ all channels		
Max. output current	20mA (1KΩ ~ 2MΩ)	-	
Tolerance load impedance	-	0 ~ 500Ω	
Digital data format	16 significant bits out of 16 bits are available; in 2's complement		
Isolation	Optical coupler isolation between digital circuits and analog circuits. No isolation among analog channels. 500VDC between digital circuits and Ground 500VDC between analog circuits and Ground 500VDC between analog circuits and digital circuits 500VDC between 24VDC and Ground		
Protection	Voltage output is protected by short circuit. Short circuit lasting for too long may cause damage on internal circuits. Current output can be open circuit.		

3 Mixed Analog Input/Output Module DVP06XA-E2

Digital/Analog (D/A)	Voltage output	Current output
D/A conversion curve (Default: mode 0)	Mode 0 (H'0000): (-10V ~ +10V) 	Mode 1 (H'0001): (0mA ~ +20mA)
	Mode 2 (H'0002): (+4mA ~ +20 mA) 	Mode -1 (H'FFFF): Channel unavailable. The channel is disabled. Output voltage = 0; output current = 0.
	Operation/storage 1. Operation: 0°C ~ 55°C (temperature), 50 ~ 95% (humidity), pollution degree 2 2. Storage: -25°C ~ 70°C (temperature), 5 ~ 95% (humidity)	
Vibration/shock immunity International standards: IEC61131-2, IEC 68-2-6 (TEST Fc) / IEC61131-2 & IEC 68-2-27 (TEST Ea)		
Power Supply		
Max. rated power consumption	24V DC (20.4 ~ 28.8V DC) (-15% ~ +20%), 3W, supplied by external power source	

3.6 CR (Control Register)

3.6.1 CR in DVP06XA-E2

DVP06XA-E2				Description
CR#	Attrib.	Register content		
#0	YES	R	Model name	Set up by the system: DVP06XA-ES2 model code = H'00C4
#1	YES	R	Firmware version	Display the current firmware version in hex.
#2	YES	R/W	CH1 Input mode setting	Input mode: Default = H'0000. Take CH1 for example: Mode 0 (H'0000): Voltage input (-10V ~ +10V). Mode 1 (H'0001): Voltage input (-5V ~ +5V). Mode 2 (H'0002): Voltage input (0V ~ +10V). Mode 3 (H'0003): Voltage input (0V ~ +5V). Mode 4 (H'0004): Current input (-20mA ~ +20mA). Mode 5 (H'0005): Current input (0mA ~ +20mA). Mode 6 (H'0006): Current input (4mA ~ +20mA). Mode -1 (H'FFFF): Channel 1 unavailable.
#3	YES	R/W	CH2 Input mode setting	
#4	YES	R/W	CH3 Input mode setting	
#5	YES	R/W	CH4 Input mode setting	
#6	YES	R/W	CH5 output mode setting	
#7	YES	R/W	CH6 output mode setting	
#8	YES	R/W	CH1 average times	Output mode: Default = H'0000. Take CH5 for example: Mode 0 (H'0000): Voltage output (-10V ~ +10V). Mode 1 (H'0001): Current output (0mA ~ +20mA). Mode 2 (H'0002): Current output (4mA ~ +20mA). Mode -1 (H'FFFF): Channel 5 unavailable.
#9	YES	R/W	CH2 average times	
#10	YES	R/W	CH3 average times	
#11	YES	R/W	CH4 average times	
#12	NO	R	CH1 average input value	
#13	NO	R	CH2 average input value	Average value of input signals at CH1 ~ CH4
#14	NO	R	CH3 average input value	
#15	NO	R	CH4 average input value	
#18 ~ #19			Reserved	
#20	NO	R	CH1 present input value	Present value of input signals at CH1 ~ CH4
#21	NO	R	CH2 present input value	
#22	NO	R	CH3 present input value	
#23	NO	R	CH4 present input value	
#24 ~ #27			Reserved	

3 Mixed Analog Input/Output Module DVP06XA-E2

DVP06XA-E2				Description
CR#	Attrib.		Register content	
#28	YES	R/W	Adjusted Offset value of CH1	Set the adjusted Offset value of Ch1 ~ Ch4. Default = K0
#29	YES	R/W	Adjusted Offset value of CH2	Definition of Offset at Ch1 ~ Ch4 in DVP06XA-E2: The corresponding voltage (current) input value when the digital output value = 0
#30	YES	R/W	Adjusted Offset value of CH3	
#31	YES	R/W	Adjusted Offset value of CH4	
#32	YES	R/W	Adjusted Offset value of CH5	Set the adjusted Offset value of Ch5 ~ Ch6. Default = K0
#33	YES	R/W	Adjusted Offset value of CH6	Definition of Offset at Ch5 ~ Ch6 in DVP06XA-E2: The corresponding voltage (current) output value when the digital input value = 0
#34	YES	R/W	Adjusted Gain value of CH1	Set the adjusted Gain value of CH1 ~ CH4. Default = K16,000
#35	YES	R/W	Adjusted Gain value of CH2	Definition of Gain at Ch1~Ch4 in DVP06XA-E2: The corresponding voltage (current) input value when the digital output value = 16,000
#36	YES	R/W	Adjusted Gain value of CH3	
#37	YES	R/W	Adjusted Gain value of CH4	
#38	YES	R/W	Adjusted Gain value of CH5	Set the adjusted Gain value of Ch5 ~ Ch6. Default = K16,000
#39	YES	R/W	Adjusted Gain value of CH6	Definition of Gain at Ch5 ~ Ch6 in DVP06XA-E2: The corresponding voltage (current) output value when the digital input value = 16,000
#40	YES	R/W	Function: Set value changing prohibited	Prohibit set value changing in CH1 ~ CH4
#41	NO	R/W	Function: Save all the set values	Save all the set values, Default =H'0000
#42	NO	R/W	Function: Return to default setting	Set all values to default setting, Default = H'0000
#43	NO	R	Error status	Register for storing all error status. See the table of error status for more information.
#44 ~ #99	Reserved			
#100	YES	R/W	Function: Enable/Disable limit detection	Enable/Disable the upper and lower bound detection function.
#101	NO	R/W	Upper and lower bound status	Display the upper and lower bound value, Default =H'0000
#102	YES	R/W	Set value of CH1 upper bound	Set value of CH1~CH6 upper bound. Default: K32,000
#103	YES	R/W	Set value of CH2 upper bound	
#104	YES	R/W	Set value of CH3 upper bound	
#105	YES	R/W	Set value of CH4 upper bound	
#106	YES	R/W	Set value of CH5 upper bound	
#107	YES	R/W	Set value of CH6 upper bound	
#108	YES	R/W	Set value of CH1 lower bound	Set value of CH1~CH6 lower bound. Default: K-32,000
#109	YES	R/W	Set value of CH2 lower bound	
#110	YES	R/W	Set value of CH3 lower bound	
#111	YES	R/W	Set value of CH4 lower bound	
#112	YES	R/W	Set value of CH5 lower bound	
#113	YES	R/W	Set value of CH6 lower bound	
#114	YES	R/W	Output update time of CH5	Set output update time of CH5 ~ CH6
#115	YES	R/W	Output update time of CH6	
#116 ~ #117	Reserved			
#118	YES	R/W	LV output mode setting of Ch5 ~ Ch6	Set the output mode of CH5~CH6 when the power is at LV (low voltage) condition. Default=0
Symbols: YES: When CR#41 is set to H'5678, the set value of CR will be saved. NO: Set value will not be saved R: Able to read data by FROM instruction, W: Able to write data by using TO instructions For voltage input Mode0/Mode2: $0.3125\text{mV} = 20\text{V}/64,000 = 10\text{V}/32,000$. For voltage input Mode1/Mode3: $0.15625\text{mV} = 10\text{V}/64,000 = 5\text{V}/32,000$ For current input Mode4/Mode5: $0.625\mu\text{A} = 40\text{mA}/64,000 = 20\text{mA}/32,000$ For current input Mode6: $0.5\mu\text{A} = 16\text{mA}/32,000$ For voltage output Mode0: $0.3125\text{mV} = 20\text{V}/64,000$ For current output Mode1: $0.625\mu\text{A} = 20\text{mA}/32,000$ For current output Mode2: $0.5\mu\text{A} = 16\text{mA}/32,000$				

3.6.2 Explanation of CR

CR#0: Model name

[Explanation]

1. DVP06XA-E2 model code = H'00C4.
2. You can read the model name in the program to see if the extension module exists.

CR#1: Firmware version

[Explanation]

Display the current firmware version in hex, e.g. version V1.00 is indicated as H'0100.

CR#2, 3, 4, 5: CH1 ~ CH4 input mode setting

[Explanation]

Set the working mode of the input channels of the analog input/output module. There are 8 modes for each channel which can be set up separately.

When you set CH1 as mode 1 (H'0001) CR#2 has to be set as H'0001. The default setting = H'0000. Take CH1 as example:

- Mode 0 (H'0000): Voltage input (-10V ~ +10V).
- Mode 1 (H'0001): Voltage input (-5V ~ +5V).
- Mode 2 (H'0002): Voltage input (0V ~ +10V).
- Mode 3 (H'0003): Voltage input (0V ~ +5V).
- Mode 4 (H'0004): Current input (-20mA ~ +20mA).
- Mode 5 (H'0005): Current input (0mA ~ +20mA).
- Mode 6 (H'0006): Current input (+4mA ~ +20mA).
- Mode -1(H'FFFF): Channel 1 unavailable..

CR#6, 7: CH5 ~ CH6 output mode setting

[Explanation]

Set the working mode of the output channels of the analog input/output module. There are 4 modes for each channel which can be set up separately.

When you set CH5 as mode 1 (H'0001) CR#6 has to be set as H'0001. The default setting = H'0000. Take CH5 as example:

- Mode 0 (H'0000): Voltage output (-10V ~ +10V).
- Mode 1 (H'0001): Current output (0mA ~ 20mA).
- Mode 2 (H'0002): Current output (4mA ~ 20mA).
- Mode close (H'FFFF): Channel 5 unavailable.

CR#8, 9, 10, 11: CH1 ~ CH4 average times

[Explanation]

1. The average times of the signals at CH1 ~ CH4.
2. Setup range for DVP06XA-E2: K1 ~ K100. Default = K10. If the set value exceeds K100, the value will be set as K100; if the set value is lower than K1, the set value will be set as K1

CR#12, 13, 14, 15: Average input values at CH1 ~ CH4

[Explanation]

The average value of the signals at CH1 ~ CH4 is calculated according to the average times set in CR#8 ~ CR#11. For example, if the set value in CR#8 ~ CR#11 is K20, the content in CR#12 ~ CR#15 will be the average of the most recent 20 signals in CH1 ~ CH4

CR#20, 21, 22, 23: Present input value at CH1 ~ CH4

[Explanation]

Display the present value of input signals at CH1 ~ CH4.

CR#28, 29, 30, 31: Adjusted Offset value of CH1 ~ CH4

[Explanation]

1. Set the adjusted Offset value of CH1 ~ CH4, which represents the voltage (current) input value corresponds to digital value 0.

3 Mixed Analog Input/Output Module DVP06XA-E2

2. Default setting = K0.

CR#32, 33: Adjusted Offset value of CH5 ~ CH6

[Explanation]

1. Set the adjusted Offset value of CH5 ~ CH6, which represents the voltage (current) output value corresponds to digital value 0
2. Default setting = K0.

CR#34, 35, 36, 37: Adjusted Gain value of CH1 ~ CH4

[Explanation]

1. Set the adjusted Gain value of CH1 ~ CH4, which represents the voltage (current) input value corresponds to digital value 16,000.
2. Default setting = K16,000.

CR#38, 39: Adjusted Gain value of CH5 ~ CH6

[Explanation]

1. Set the adjusted Gain value of CH5 ~ CH6, which represents the voltage (current) output value corresponds to digital value 16,000.
2. Default setting = K16,000.

CR#40: Function: Set value changing prohibited, Default = H'0000

[Explanation]

Description	
bit0	b0=0, CH1 changing allowed; b0=1, CH1 changing prohibited
bit1	b1=0, CH2 changing allowed; b1=1, CH2 changing prohibited
bit2	b2=0, CH3 changing allowed; b2=1, CH3 changing prohibited
bit3	b3=0, CH4 changing allowed; b3=1, CH4 changing prohibited
bit4	b4=0, CH5 changing allowed; b4=1, CH5 changing prohibited
bit5	b5=0, CH6 changing allowed; b5=1, CH6 changing prohibited
bit6 ~ bit15	Reserved

Relative Parameters	
CR#2 ~ CR#5	Input mode setting at CH1 ~ CH4
CR#6 ~ CR#7	Output mode setting at CH5 ~ CH6
CR#8 ~ CR#11	Average times of CH1 ~ CH4
CR#28 ~ CR#33	Adjusted Offset value of CH1 ~ CH6
CR#34 ~ CR#39	Adjusted Gain value of CH1 ~ CH6
CR#42	Return to default setting
CR#100	Function: Enable/Disable limit detection
CR#102~CR#107	Set value of CH1~CH6 upper bound
CR#108~CR#113	Set value of CH1~CH6 lower bound
CR#114~CR#115	Output update time of CH5~ CH6
CR#118	LV output mode setting of Ch5 ~ Ch6

CR#41: Function: Save all the set values. Default=H'0000

[Explanation]

Save function setting. Save all the set values to the internal flash memory. When saving is completed, CR#41 will be set to H'FFFF.

Set value	Function
H0	No action
HFFFF	Saving completed
H5678	Saving enabled.

Note: Default setting = H0. When set value = H'5678, saving will be enabled, and CR#41 will be set to H'FFFF when saving is completed. If the set value is not H'5678, the set value will remain H'0. For example, input K1 into CR#41, and the value will remain H'0.

CR#42: Function: Return to default setting. Default = H0000

[Explanation]

Description	
bit0	b0=0, no action on CH1; b0=1, set CH1 to default setting
bit1	b1=0, no action on CH2; b1=1, set CH2 to default setting
bit2	b2=0, no action on CH3; b2=1, set CH3 to default setting
bit3	b3=0, no action on CH4; b3=1, set CH4 to default setting
bit4	B4=0, no action on CH5; b4=1, set CH5 to default setting
bit5	B5=0, no action on CH6; b5=1, set CH6 to default setting
bit6 ~ bit15	Reserved

Note: Set designated bit as 1 and the corresponding channel will be returned to default setting. When setting is completed, the value will be set to 0. If CR#40(Set value changing prohibited) is enabled, the default setting in CR#42 will be invalid, and all set values will remain unchanged. Error Code bit 12 of CR#43 will be set to 1.

Relative Parameters	
CR#2 ~ CR#5	Input mode setting of CH1 ~ CH4
CR#6 ~ CR#7	Output mode setting at CH5 ~ CH6
CR#8 ~ CR#11	Average times of CH1 ~ CH4
CR#28 ~ CR#33	Adjusted Offset value at CH1 ~ CH6
CR#34 ~ CR#39	Adjusted Gain value at CH1 ~ CH6
CR#100	Function: Enable/Disable limit detection
CR#102~CR#107	Set value of CH1~CH6 upper bound
CR#108~CR#113	Set value of CH1~CH6 lower bound
CR#114~CR#115	Output update time of CH5 ~ CH6
CR#118	LV output mode setting

CR#43: Error status. Default=H'0000

[Explanation]

CR#43: error status value. See the table below:

Description		
bit0	K1 (H'1)	Power Supply error
bit1	K2 (H'2)	Hardware error
bit2	K4 (H'4)	Upper / lower limit error
bit3	K8 (H'8)	CH1 Conversion error
bit4	K16 (H'10)	CH2 Conversion error
bit5	K32 (H'20)	CH3 Conversion error
bit6	K64 (H'40)	CH4 Conversion error
bit7	K128 (H'80)	CH5 Conversion error
bit8	K256 (H'100)	CH6 Conversion error
bit9	K512(H'0200)	Mode setting error
bit10	K1024(H'0400)	Average times error
bit11	K2048(H'0800)	Upper / lower bound setting error
bit12	K4096(H'1000)	Set value changing prohibited
bit13	K8192(H'2000)	Communication breakdown on next module
bit14 ~ bit15		Reserved

 **Note:** Each error status is determined by the corresponding bit (b0 ~ b13) and there may be more than 2 errors occurring at the same time. 0 = normal; 1 = error

CR#100: Function: Enable/Disable limit detection

[Explanation]

Description	
bit0=1	Enable CH1 limit detection
bit1=1	Enable CH2 limit detection
bit2=1	Enable CH3 limit detection
bit3=1	Enable CH4 limit detection
bit4=1	Enable CH5 limit detection
bit5=1	Enable CH6 limit detection

3 Mixed Analog Input/Output Module DVP06XA-E2

Description	
bit6 ~ bit7	Reserved
bit8=1	Enable upper/lower bound limitation function on CH5.
bit9=1	Enable upper/lower bound limitation function on CH6
bit12 ~ bit15	Reserved

CR#101: Upper and lower bound status

[Explanation]

Description	
bit0=1	CH1 exceeds lower bound
bit1=1	CH2 exceeds lower bound
bit2=1	CH3 exceeds lower bound
bit3=1	CH4 exceeds lower bound
bit4=1	CH5 exceeds lower bound
bit5=1	CH6 exceeds lower bound
bit6 ~ bit7	Reserved
bit8=1	CH1 exceeds upper bound
bit9=1	CH2 exceeds upper bound
bit10=1	CH3 exceeds upper bound
bit11=1	CH4 exceeds upper bound
bit12=1	CH5 exceeds upper bound
bit13=1	CH6 exceeds upper bound
bit14 ~ bit15	Reserved

CR#102, 103, 104, 105, 106, 107: Set value of CH1 ~ CH6 upper bound

[Explanation]

Set the upper bound value of CH1 ~ CH6. Default: K32,000

CR#108, 109, 110, 111, 112, 113: Set value of CH1 ~ CH6 lower bound

[Explanation]

Set the lower bound value of CH1 ~ CH6. Default: -32,000

CR#114, 115: Output update time of CH5~ CH6

[Explanation]

Unit: 100ms

Range	Default
1~100 (0.1s~10s)	0(unavailable)

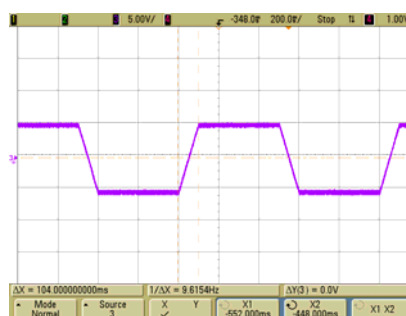
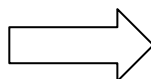
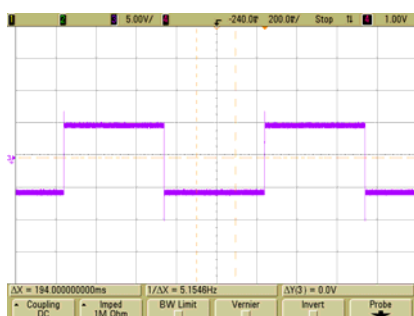

CR#118: LV output mode setting of CH5 ~ CH6. Default=0

[Explanation]

CR[118]=0: When the power is at LV (low voltage) condition, the output performs natural discharge.

CR[118]=1: When the power is at LV condition, set the output value as 0. See the curve below:

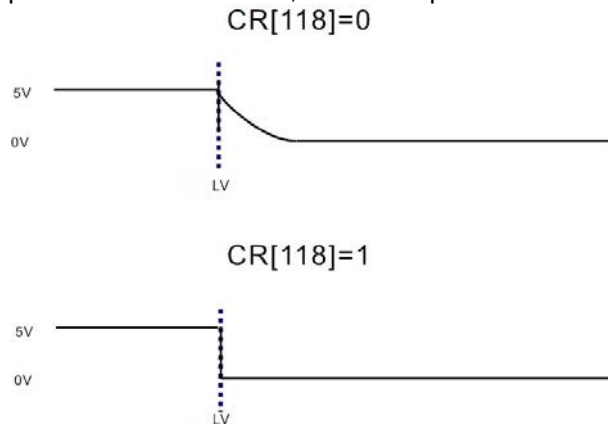

3.6.3 Explanation on Special Registers D9900~D9999

When ES2 MPU is connected with modules, registers D9900~D9999 will be reserved for storing values from modules. You can apply MOV instruction to operate values in D9900~D9999.

When ES2 MPU is connected with DVP06XA-E2, the configuration of special registers is as below:

Module#0	Module#1	Module#2	Module#3	Module#4	Module#5	Module#6	Module#7	Description
D1320	D1321	D1322	D1323	D1324	D1325	D1326	D1327	Model Code
D9900	D9910	D9920	D9930	D9940	D9950	D9960	D9970	CH1 average input value
D9901	D9911	D9921	D9931	D9941	D9951	D9961	D9971	CH2 average input value
D9902	D9912	D9922	D9932	D9942	D9952	D9962	D9972	CH3 average input value
D9903	D9913	D9923	D9933	D9943	D9953	D9963	D9973	CH4 average input value
D9904	D9914	D9924	D9934	D9944	D9954	D9964	D9974	CH5 output value
D9905	D9915	D9925	D9935	D9945	D9955	D9965	D9975	CH6 output value

- D9900~D9999 are average input values of CH1 ~ CH6 and the average times is K1~K100. When the average times is set to K1, the values displayed in D9900~D9999 are current values. You can use: 1. ES_AIO Configuration Function of WPLSoft (refer to 3.8 Applications in this manual) or 2. FROM/TO instructions (CR#8~CR#11) to set the average times as K1

- Example:

Ladder diagram:

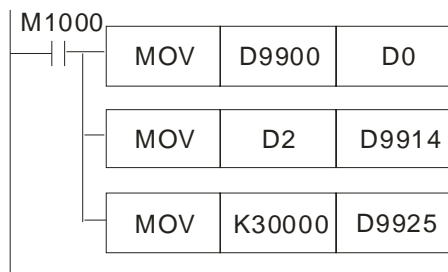

Explanation:

Save CH1 average input value of Module#0 to D0

Set CH5 output value of Module#1 as D2

Set CH6 output value of Module#2 as K30000

3.7 A/D and D/A Conversion Curve

3.7.1 Adjusting A/D Conversion Curve of CH1 ~ CH4

You can adjust the conversion curves according to the actual needs by changing the Offset value (CR#28 ~ CR#31) and Gain value (CR#34 ~ CR#37).

Gain (in DVP06XA-E2): The voltage (current) input value corresponds to digital value 16,000.

Offset (in DVP06XA-E2): The voltage (current) input value corresponds to digital value 0.

3 Mixed Analog Input/Output Module DVP06XA-E2

- For voltage input Mode0/Mode2: $0.3125\text{mV} = 20\text{V}/64,000 = 10\text{V}/32,000$
Equation:

$$Y = \frac{16000 \times \left(\frac{X(V)}{10(V)} \times 32000 - \text{Offset} \right)}{\text{Gain} - \text{Offset}}$$

Y=Digital value, X=Voltage input

- For voltage input Mode1/Mode3: $0.15625\text{mV} = 10\text{V}/64,000 = 5\text{V}/32,000$
Equation:

$$Y = \frac{16000 \times \left(\frac{X(V)}{5(V)} \times 32000 - \text{Offset} \right)}{\text{Gain} - \text{Offset}}$$

Y=Digital value, X=Voltage input

- For current input Mode4/Mode5: $0.625\mu\text{A} = 40\text{mA}/64,000 = 20\text{mA}/32,000$
Equation:

$$Y = \frac{16000 \times \left(\frac{X(\text{mA})}{20(\text{mA})} \times 32000 - \text{Offset} \right)}{\text{Gain} - \text{Offset}}$$

Y=Digital value, X= Current input

- For current input Mode6: $0.5\mu\text{A} = 16\text{mA}/32,000$
Adopt the equation of current input mode4/mode5, substitute Gain for 19,200(12mA) and Offset for 6,400(4mA)
Equation:

$$Y = \frac{16000 \times \left(\frac{X(\text{mA})}{20(\text{mA})} \times 32000 - 6400 \right)}{19200 - 6400}$$

Y=Digital value, X= Current input

1. Voltage input mode

- Mode 0 (H'0000): (-10V ~ +10V)

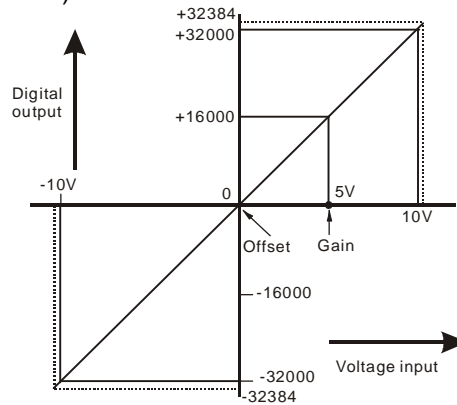

Mode 0 of CR#2~ CR#5	-10V ~ +10V, Gain = 5V (16,000), Offset = 0V (0).
Gain (CR#34 ~ CR#37)	The voltage input value corresponds to digital value 16,000.
Offset (CR#28 ~ CR#31)	The voltage input value corresponds to digital value 0.
Range of digital conversion	-32,000 ~ +32,000
Max./Min. output range of digital data	-32,384 ~ +32,384

3 Mixed Analog Input/Output Module DVP06XA-E2

- Mode 1 (H'0001): (-5V ~ +5V)

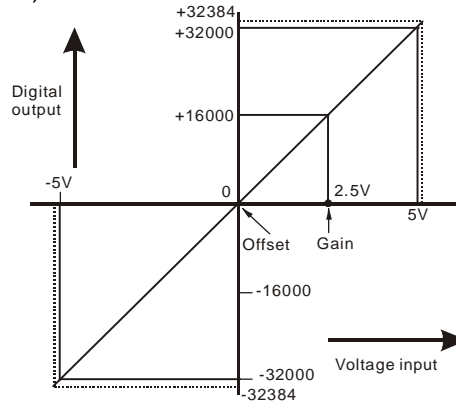

Mode 1 of CR#2~ CR#5	-5V ~ +5V, Gain = 2.5V (16,000), Offset = 0V (0).
Gain (CR#34 ~ CR#37)	The voltage input value corresponds to digital value 16,000.
Offset (CR#28 ~ CR#31)	The voltage input value corresponds to digital value 0.
Range of digital conversion	-32,000 ~ +32,000
Max./Min. output range of digital data	-32,384 ~ +32,384

- Mode 2 (H'0002): (0V~+10V)

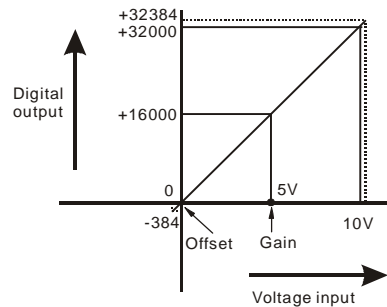

Mode 2 of CR#2~ CR#5	0V ~ +10V, Gain = 5V (16,000), Offset = 0V (0).
Gain (CR#34 ~ CR#37)	The voltage input value corresponds to digital value 16,000.
Offset (CR#28 ~ CR#31)	The voltage input value corresponds to digital value 0.
Range of digital conversion	0 ~ 32,000
Max./Min. output range of digital data	-384 ~ +32,384

- Mode 3 (H'0003): (0V~+5V)

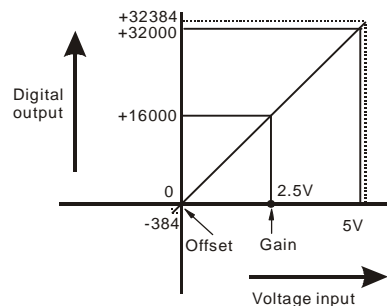

Mode 3 of CR#2~ CR#5	0V ~ +5V, Gain = 2.5V (16,000), Offset = 0V (0).
Gain (CR#34 ~ CR#37)	The voltage input value corresponds to digital value 16,000.
Offset (CR#28 ~ CR#31)	The voltage input value corresponds to digital value 0.
Range of digital conversion	0 ~ 32,000
Max./Min. output range of digital data	-384 ~ +32,384

3 Mixed Analog Input/Output Module DVP06XA-E2

2. Current input mode

- Mode 4 (H'0004): (-20mA ~ +20mA)

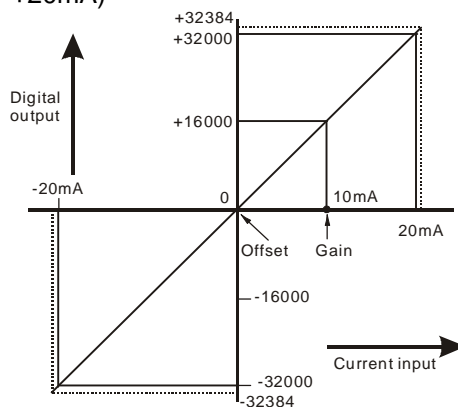

Mode 4 of CR#2~ CR#5	-20mA ~ +20mA, Gain = 10mA (16,000), Offset = 0mA (0).
Gain (CR#34 ~ CR#37)	The current input value corresponds to digital value 16,000.
Offset (CR#28 ~ CR#31)	The current input value corresponds to digital value 0.
Range of digital conversion	-32,000 ~ +32,000
Max./Min. output range of digital data	-32,384 ~ +32,384

- Mode 5 (H'0005): (0 ~ +20mA)

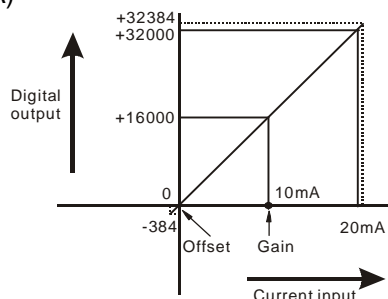

Mode 5 of CR#2~ CR#5	0mA ~ +20mA, Gain = 10mA (16,000), Offset = 0mA (0).
Gain (CR#34 ~ CR#37)	The current input value corresponds to digital value 16,000.
Offset (CR#28 ~ CR#31)	The current input value corresponds to digital value 0.
Range of digital conversion	0 ~ 32,000
Max./Min. output range of digital data	-384 ~ +32,384

- Mode 6 (H'0006): (+4mA ~ +20mA)

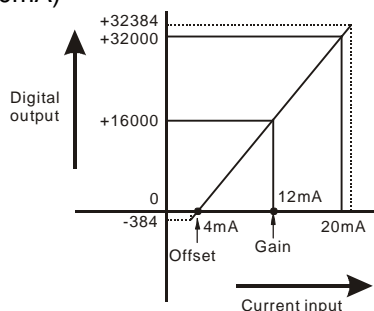

Mode 6 of CR#2~ CR#5	+4mA ~ +20mA, Gain = 12mA (19,200), Offset = 4mA (6,400).
Gain (CR#34 ~ CR#37)	The current input value when the digital output value = 16,000.
Offset (CR#28 ~ CR#31)	The current input value when the digital output value = 0.
Range of digital conversion	0 ~ 32,000
Max./Min. output range of digital data	-384 ~ +32,384

3.7.2 Adjusting D/A Conversion Curve of CH5 ~ CH6

You can adjust the conversion curves according to the actual needs by changing the Offset value (CR#32 ~ CR#33) and Gain value (CR#38 ~ CR#39).

Gain (in DVP06XA-E2): The voltage (current) output value corresponds to digital value 16,000.

3 Mixed Analog Input/Output Module DVP06XA-E2

Offset (in DVP06XA-E2): The voltage (current) output value corresponds to digital value 0.

- For voltage output Mode 0: $0.3125\text{mV} = 20\text{V}/64,000$

Equation

$$Y(V) = \left[\frac{X \times (\text{Gain} - \text{Offset})}{16000} + \text{Offset} \right] \times \left(\frac{10(V)}{32000} \right)$$

Y= Voltage output, X= Digital value

- For current output Mode 1: $0.625\mu\text{A} = 20\text{mA}/32,000$.

Equation

$$Y(\text{mA}) = \left[\frac{X \times (\text{Gain} - \text{Offset})}{16000} + \text{Offset} \right] \times \left(\frac{20(\text{mA})}{32000} \right)$$

Y= Current output, X= Digital value

- For current output Mode 2: $0.5\mu\text{A} = 16\text{mA}/32,000$

Adopt the equation of current output Mode 1, substitute Gain for 19,200(12mA) and Offset for 6,400(4mA)

Equation:

$$Y(\text{mA}) = \left[\frac{X \times (19200 - 6400)}{16000} + 6400 \right] \times \left(\frac{20(\text{mA})}{32000} \right)$$

Y= Current output, X= Digital value

1. Voltage output mode

- Mode 0 (H'0000): (-10V ~ +10V)

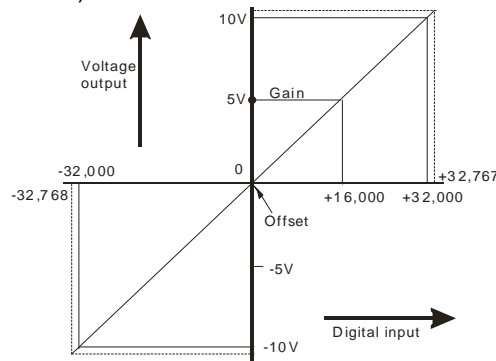

Mode 0 of CR#2~ CR#5	-10V ~ +10V, Gain = 5V (16,000), Offset = 0V (0).
Gain (CR#38 ~ CR#39)	The voltage output value corresponds to digital value 16,000.
Offset (CR#32 ~ CR#33)	The voltage output value corresponds to digital value 0.
Range of digital conversion	-32,000 ~ +32,000
Max./Min. input range of digital data	-32,768 ~ +32,767

2. Current output mode

- Mode 1 (H'0001): (0mA ~ +20mA)

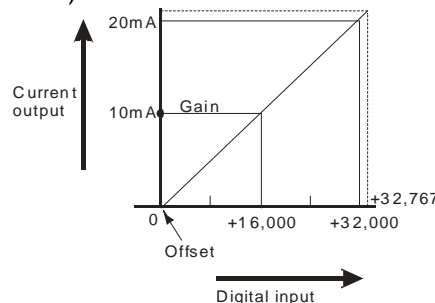

Mode 1 of CR#2~ CR#5	0mA ~ +20mA, Gain = 10mA (16,000), Offset = 0mA (0).
Gain (CR#38 ~ CR#39)	The current output value corresponds to digital value 16,000.
Offset (CR#32 ~ CR#33)	The current output value corresponds to digital value 0.
Range of digital conversion	0 ~ +32,000
Max./Min. input range of digital data	0 ~ +32,767

3 Mixed Analog Input/Output Module DVP06XA-E2

- Mode 2 (H'0002): (4mA ~ +20mA)

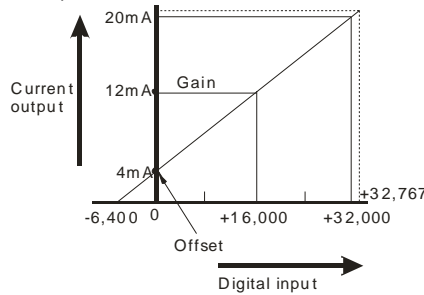

Mode 2 of CR#2~ CR#5	4mA ~ +20mA, Gain = 12mA (19,200), Offset = 4mA (6,400).
Gain (CR#38 ~ CR#39)	The current output value corresponds to digital value 19,200.
Offset (CR#32 ~ CR#33)	The current output value corresponds to digital value 6,400.
Range of digital conversion	0 ~ +32,000
Max./Min. input range of digital data	-6400 ~ +32,767

3.7.3 Adjusting A/D Conversion Curve in Voltage Input Mode 0 & Mode 2

1. Description

- Take 06XA CH1 for example. When CR#2 is set as voltage input mode (mode 0), the Offset value will be set as 0V (0) and Gain value as 5V (5V/0.3215mV=16,000), i.e. input voltage -10V ~ +10V will correspond to values -32,000 ~ +32,000.
- When CR#2 is set as voltage input mode (mode 2), the Offset value will be set as 0V (0) and Gain value as 5V (5V/0.3215mV=16,000), i.e. input voltage 0V ~ +10V will correspond to values 0 ~ +32,000.
- If you cannot use the default voltage input mode (mode 0 and mode 2), you can make adjustments on the A/D conversion curve according to your actual needs. For example, Set the Offset of CH1 as 2V (2V/0.3215mV=6,400) and Gain as 6V (6V/0.3215mV=19,200).

$$Y = \frac{16000 \times \left(\frac{X(V)}{10(V)} \times 32000 - \text{Offset} \right)}{\text{Gain} - \text{Offset}}$$

Example: If X=6V, Y=?

$$Y = \frac{16000 \times \left(\frac{6(V)}{10(V)} \times 32000 - 6400 \right)}{(19200 - 6400)} = 16000$$

- You only need to set up the A/D conversion curve for once. Set up CR#40 (Set value changing prohibited) to prevent incorrect operations.

2. Adjusted Curve

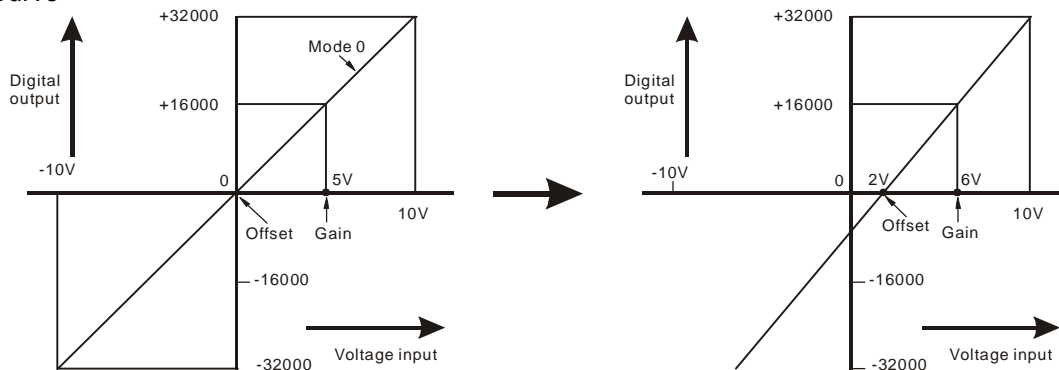

3. Devices

- X0 = On: Set the input mode of the signals at CH1 as mode 0.
- X1 = On: Set Offset value of CH1 as 2V (6,400) and Gain value as 6V (19,200).
- M0 = On: Disable CH1 set value changing.

4. Program explanation

- When X0 = On, set CR#2 as K0 (H'0000) and the signal input mode at CH1 as mode 0 (voltage input mode).
- When X1 = On, write K6,400 (Offset value of CH1) into CR#28 and K19,200 (Gain value of CH1) into

CR#24.

- When X1 goes from On to Off, set M0 = On to disable the adjustment on A/D conversion curve. Write K1 (H'1) into CR#40 b0=1 to disable CH1 set value changing.

5. Program example

Ladder diagram:

Explanation:

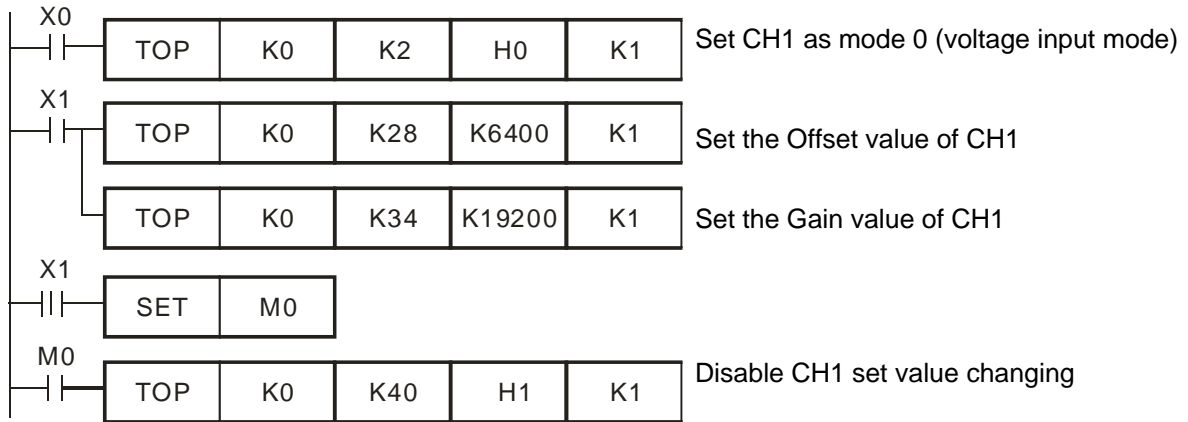

3.7.4 Adjusting A/D Conversion Curve in Voltage Input Mode 1 & Mode 3

1. Description

- Take 06XA CH2 for example. When CR#3 is set as voltage input mode (mode 1), the Offset value will be set as 0V (0) and Gain value as 2.5V (2.5V/0.15625mV=16,000), i.e. input voltage -5V ~ +5V will correspond to values -32,000 ~ +32,000.
- When CR#3 is set as voltage input mode (mode 3), the Offset value will be set as 0V (0) and Gain value as 2.5V (2.5V/0.15625mV=16,000), i.e. input voltage 0V ~ +5V will correspond to values 0 ~ +32,000.
- If you cannot use the default voltage input mode (mode 1 and mode 3), you can make adjustments on the A/D conversion curve according to your actual needs. For example, set the Offset of CH2 as 1V (1V/0.15625mV=6,400) and Gain as 3V (3V/0.15625mV=19,200).

$$Y = \frac{16000 \times \left(\frac{X(V)}{5(V)} \times 32000 - Offset \right)}{(Gain - Offset)}$$

Example: If X=3V, Y=?

$$Y = \frac{16000 \times \left(\frac{3(V)}{5(V)} \times 32000 - 6400 \right)}{(19200 - 6400)} = 16000$$

- You only need to set up the A/D conversion curve for once. Set up CR#40 (Set value changing prohibited) to prevent incorrect operations.

2. Adjusted Curve

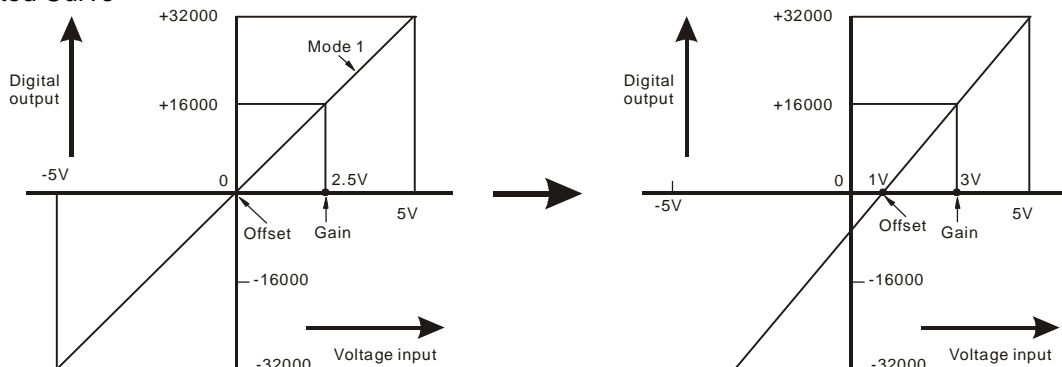

3. Devices

- X0 = On: Set the input mode of the signals at CH2 as mode 1.
- X1 = On: Set Offset value of CH2 as 1V (6,400) and Gain value as 3V (19,200).
- M0 = On: Disable CH2 set value changing.

3 Mixed Analog Input/Output Module DVP06XA-E2

4. Program explanation

- When X0 = On, set CR#3 as K1 (H'0001) and the signal input mode at CH2 as mode 1 (voltage input mode).
- When X1 = On, write K6,400 (Offset value of CH2) into CR#29 and K19,200 (Gain value of CH2) into CR#35.
- When X1 goes from On to Off, set M0 = On to disable the adjustment on A/D conversion curve. Write K2 (H'2) into CR#40 b1=1 to disable CH2set value changing.

5. Program example

Ladder diagram:

Explanation:

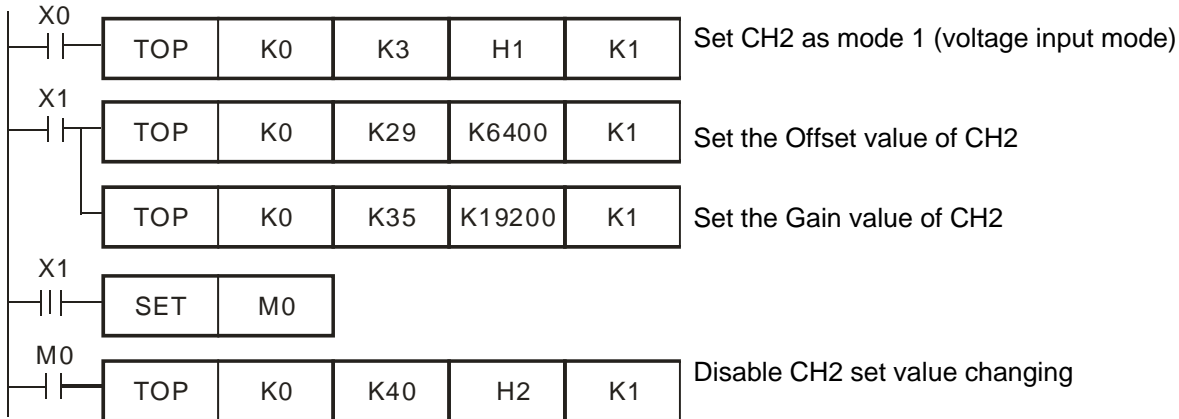

3.7.5 Adjusting A/D Conversion Curve in Current Input Mode 4, Mode 5 and Mode6

1. Description

- Take 06XA CH3 for example. When CR#4 is set as current input mode (mode 4), the Offset value will be set as 0mA (0) and Gain value as 10mA (10mA/0.625μA=16,000), i.e. input current -20mA ~ +20mA will correspond to values -32,000 ~ +32,000.
- When CR#4 is set as current input mode (mode 5), the Offset value will be set as 0mA (0) and Gain value as 10mA (10mA/0.625 μA=16,000), i.e. input current 0mA ~ +20mA will correspond to values 0 ~ +32,000.
- When CR#4 is set as current input mode (mode 6), the Offset value will be set as 4mA (4mA/0.625 μA=6,400) and Gain value as 12mA (12mA/0.625 μA=19,200), i.e. input current 4mA ~ +20mA will correspond to values 0 ~ +32,000.
- If you cannot use the default current input mode (mode 4 ~ mode 6), you can make adjustments on the A/D conversion curve according to your actual need. For example, Set the Offset of CH3 as 8mA (8mA/0.625μA=12,800) and Gain as 14mA (14mA/0.625μA=22,400).

$$Y = \frac{16000 \times \left(\frac{X(mA)}{20(mA)} \times 32000 - \text{Offset} \right)}{\text{Gain} - \text{Offset}}$$

Example: If X=14mA, Y=?

$$Y = \frac{16000 \times \left(\frac{14(mA)}{20(mA)} \times 32000 - 12800 \right)}{(22400 - 12800)} = 16000$$

- You only need to set up the A/D conversion curve for once. Set up CR#40 (Set value changing prohibited) to prevent incorrect operations.

2. Adjusted Curve

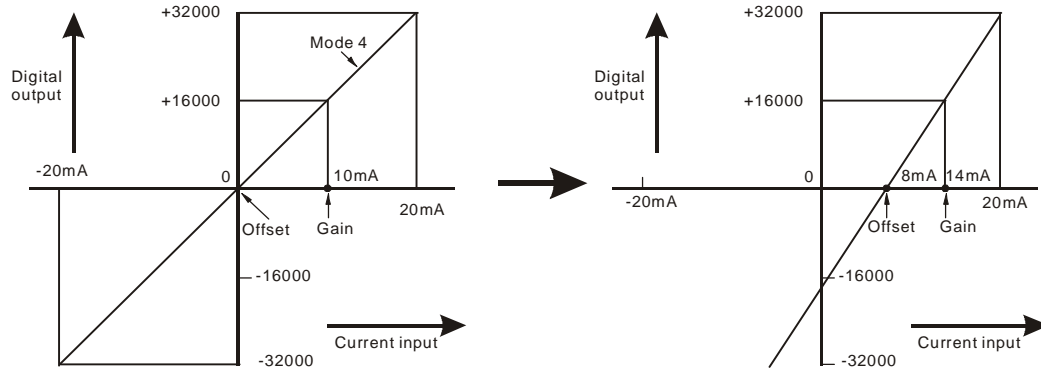

3. Devices

- X0 = On: Set the input mode of the signals at CH3 as mode 4.
- X1 = On: Set Offset value of CH3 as 8mA (12,800) and Gain value as 14mA (22,400).
- M0 = On: Disable CH3 set value changing.

4. Program explanation

- When X0 = On, set CR#4 as K4 (H'4) and the signal input mode at CH3 as mode 4 (current input mode).
- When X1 = On, write K12,800 (Offset value of CH3) into CR#30 and K22,400 (Gain value of CH3) into CR#36.
- When X1 goes from On to Off, set M0 = On to disable the adjustment on A/D conversion curve. Write K4 (H'4) into CR#40 to disable CH3 set value changing.

5. Program example

Ladder Diagram:



Explanation:

Set CH3 as mode 4 (current input mode)

Set the Offset value of CH3

Set the Gain value of CH3

Disable CH3 set value changing.

3.7.6 Adjusting D/A Conversion Curve in Voltage Output Mode

1. Description

- Take 06XA CH5 for example. When CR#6 is set as voltage output mode (mode 0), the Offset value will be set as 0V (0) and Gain value as 5V (5V/0.3215mV=16,000), i.e. output voltage -10V ~ 10V will correspond to values -32,000 ~ +32,000.
- If you cannot use the default voltage output mode (mode 0), you can make adjustments on the D/A conversion curve according to your actual need. For example, set the Offset of CH5 ~ CH6 as 2V (2V/0.3215mV=6,400) and Gain as 6V (6V/0.3215mV=19,200).

$$Y(V) = \left[\frac{X \times (Gain - Offset)}{16000} + Offset \right] \times \left(\frac{10(V)}{32000} \right)$$

Example: If X=16000, Y=?

$$Y(V) = \left[\frac{16000 \times (19200 - 6400)}{16000} + 6400 \right] \times \left(\frac{10(V)}{32000} \right) = 6(V)$$

- You only need to set up the D/A conversion curve for once. Set up CR#40 (Set value changing prohibited) to prevent incorrect operations.

3 Mixed Analog Input/Output Module DVP06XA-E2

2. Adjusted Curve

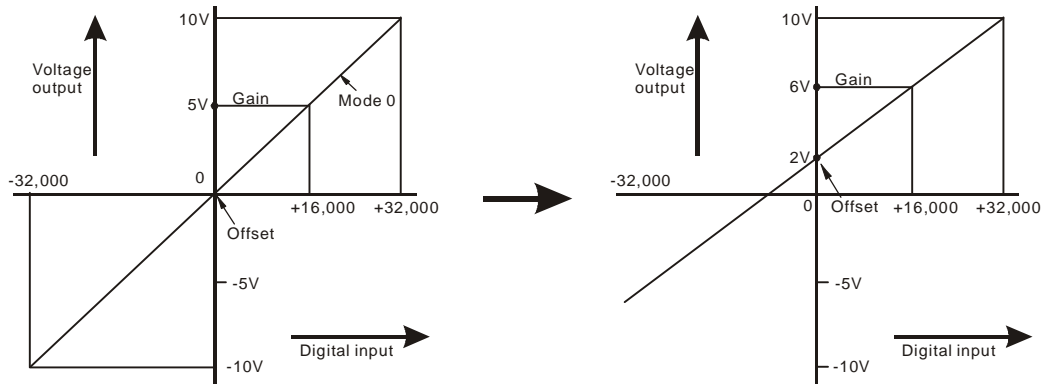

3. Devices

- X0 = On: Set the output mode of the signals at CH5 as mode 0.
- X1 = On: Set Offset value of CH5 as 2V (6,400) and Gain value as 6V (19,200).
- M0 = On: Disable CH5 set value changing.

4. Program explanation

- When X0 = On, set CR#6 as K0 (H'0000) and the signal output mode at CH5 as mode 0 (voltage output mode).
- When X1 = On, write K6400 (Offset value of CH5) into CR#32 and K19,200 (Gain value of CH5) into CR#38.
- When X1 goes from On to Off, set M0 = On to disable the adjustment on D/A conversion curve. Write K16 (H'10) into CR#40 b4=1 to disable CH5set value changing.

5. Program example

Ladder diagram:

Explanation:

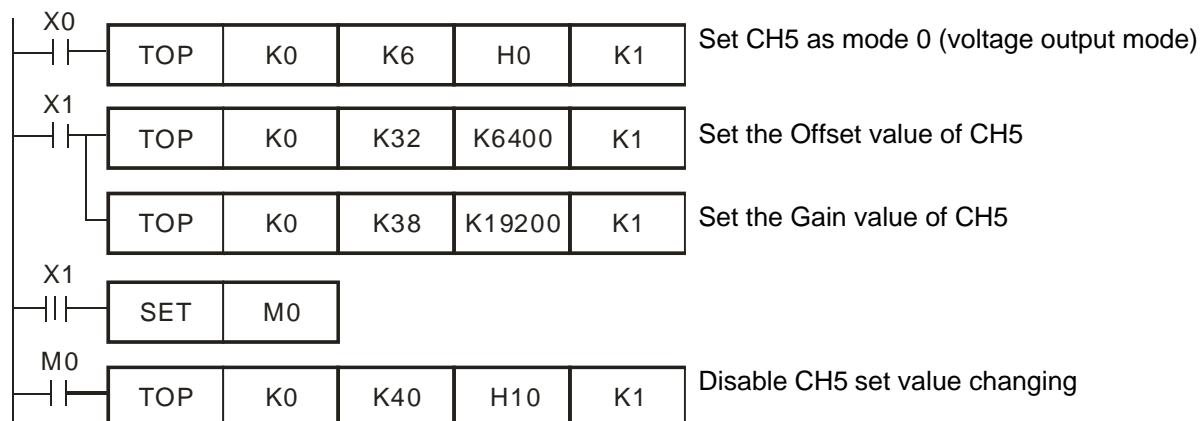

3.7.7 Adjusting D/A Conversion Curve in Current Output Mode 1 and Mode 2

1. Description

- Take 06XA CH6 for example. When CR#7 is set as current output mode (mode 1), the Offset value will be set as 0mA (0) and Gain value as 10mA (10mA/0.625μA=16,000), i.e. output current 0mA ~ +20mA will correspond to values 0 ~ +32,000.
- When CR#7 is set as current output mode (mode 2), the Offset value will be set as 4mA (4mA/0.625μA=6,400) and Gain value as 12mA (12mA/0.625μA=19,200), i.e. input current 4mA ~ +20mA will correspond to values 0 ~ +32,000.
- If you cannot use the default current output mode (mode 1 and mode 2), you can make adjustments on the D/A conversion curve according to your actual needs. For example, set the Offset of CH6 as 6mA (6mA/0.625μA=9,600) and Gain as 13mA (13mA/0.625μA=20,800).

$$Y(mA) = \left[\frac{X \times (\text{Gain} - \text{Offset})}{16000} + \text{Offset} \right] \times \left(\frac{20(mA)}{32000} \right)$$

Example: If X=16000, Y=?

$$Y(mA) = \left[\frac{16000 \times (20800 - 9600)}{16000} + 9600 \right] \times \left(\frac{20(mA)}{32000} \right) = 13(mA)$$

- You only need to set up the D/A conversion curve for once. Set up CR#40 (Set value changing prohibited) to prevent incorrect operations.

2. Adjusted Curve

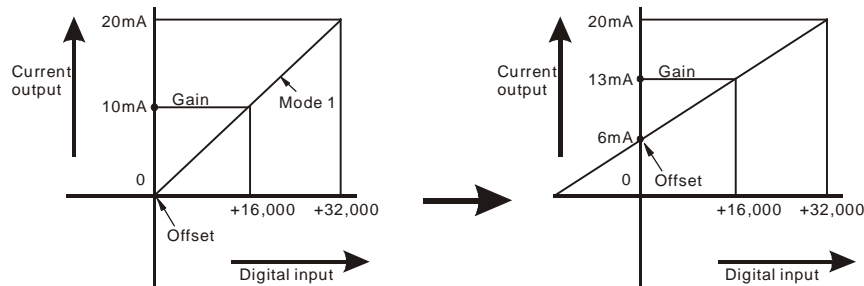

3. Devices

- X0 = On: Set the output mode of the signals at CH6 as mode 1.
- X1 = On: Set Offset value of CH6 as 6mA (9,600) and Gain value as 13mA (20,800).
- M0 = On: Disable CH6 set value changing

4. Program explanation

- When X0 = On, set CR#7 as K1 (H'0001) and the signal output mode at CH6 as mode 1 (current output mode).
- When X1 = On, write K9,600 (Offset value of CH6) into CR#33 and K20,800 (Gain value of CH6) into CR#39.
- When X1 goes from On to Off, set M0 = On to disable the adjustment on D/A conversion curve. Write K32 (H'20) into CR#40 b5=1 to disable CH6 set value changing.

5. Program example

Ladder diagram:



Explanation:

Set CH6 as mode 1 (current output mode)

Set the Offset value of CH6

Set the Gain value of CH6

Disable CH6 set value changing

3.8 Applications

3.8.1 Speed Tracing of AC Motor Drive

1. Description

- The multi-functional voltage output terminal (AFM) on VFD-B series AC motor drive model A offers signals of present speed (0 ~ 50Hz) which corresponds to 0 ~ 10V analog output signals to DVP06XA-E2, and 06XA will then offer analog voltage output to the voltage input terminal (AUI) on VFD-B series AC motor drive model B, for executing auto speed tracing of the AC motor drive.
- Set the input signals of CH1 as mode 2, i.e. the voltage input mode (0V ~ 10V)
- Set the output signal of CH5 as mode 0, i.e. the voltage output mode (-10V ~ 10V).

2. Devices

- D0: present voltage value measured
- D4: frequency of VFD-B model A
- D40: average digital value of the input signals at CH1
- D50: present digital value of input signal at CH1
- D60: corresponding digital value of output voltage at CH5

3. Wiring

- Connect the analog voltage output terminal (AFM/ACM) on VFD-B model A to CH1 of DVP06XA-E2 and connect the analog voltage input terminal (AUI/ACM) on VFD-B model B to CH5 of DVP06XA-E2 (as shown on the next page).

3 Mixed Analog Input/Output Module DVP06XA-E2

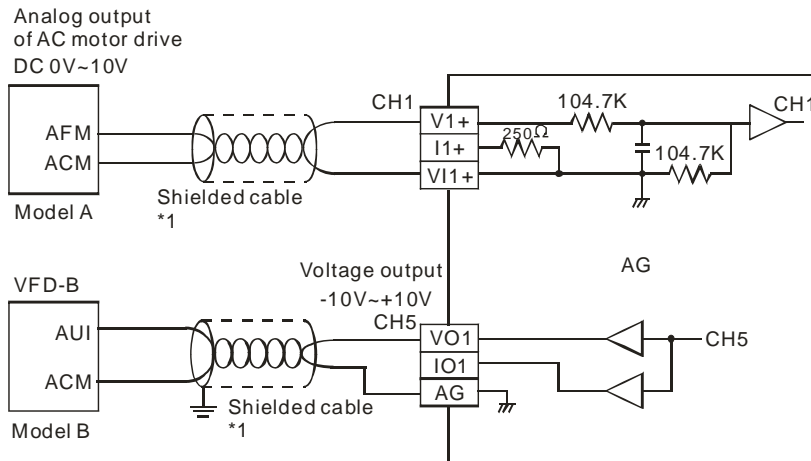

4. Program explanation

- When PLC goes from STOP to RUN, because VFD-B model A offers analog voltage output 0 ~ 10VDC to 06XA, you have to set CH1 as voltage input mode (mode 2) and CH5 as voltage output mode (mode 0). In addition, set the average times of the input signals at CH1 as 10.
- Save the present digital value of the input signal measured into D50.
- In the voltage input mode of 06XA, The value range for 0 ~ 10V DC is K0 ~ K32,000. Data in D50 is 3,200 times of the actual voltage value (i.e. 32,000/10 = 3,200). Divide the value in D50 by 3,200 and store the value obtained into D0 which represents the actual voltage measured.
- Frequency range 0 ~ 50.0Hz corresponds to 0 ~ 10V. Multiply the value in D0 with 5 and store the value obtained into D4 which represents actual frequency value
- In the voltage output mode of 06XA, the value range for -10V ~ 10V is K-32,000 ~ K32,000. D4 is the frequency of VFD-B model A. FWD/REV frequency -50Hz ~ 50Hz corresponds to K-32,000~ K32,000 (32,000/50 = 640). Multiply the value in D4 with 640 and store the digital value obtained into D60 which represents the corresponding digital value of Ch5 output voltage.

5. Program example

Ladder diagram:

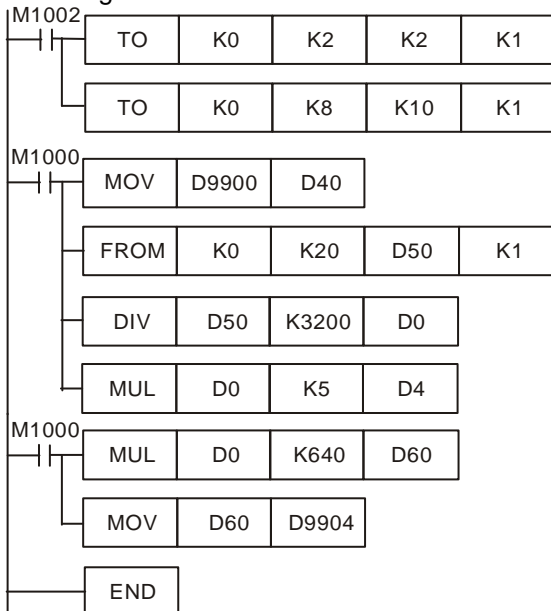

Explanation:

Set CH1 as mode 0

Set the average times of CH1 signals as 10

Store the average digital value of CH1 signals into D40

Store the present digital value of input signals into D50

$D50/3200 = D0$, the voltage measured

$D0*5 = D4$, the output frequency of VFD-B model A

Multiply D4 with 640 to obtain the output value of VFD-B Model B.

D60 is the corresponding digital value of Ch5 output voltage.

3.8.2 How to Set the Module Wizard in WPLSoft

1. Open WPLSoft and click on .

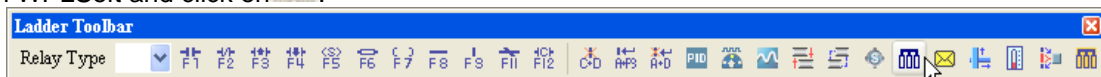

3 Mixed Analog Input/Output Module DVP06XA-E2

- You will see the “Auxiliary Design of Extension Module” window. Click on NO. “0” and select “DVP06XA-E2 Analog Input/Output Mixed Module”. Click on “Setup” button next.

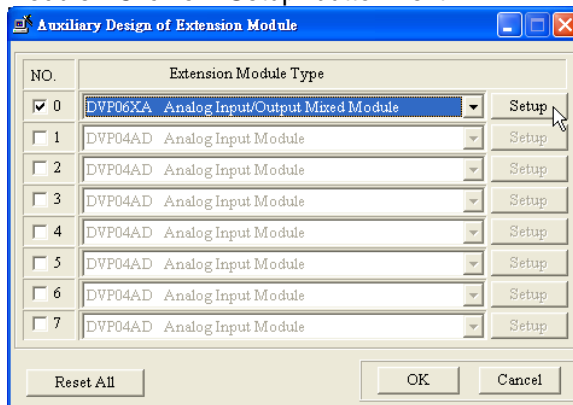

- You will then see this window.

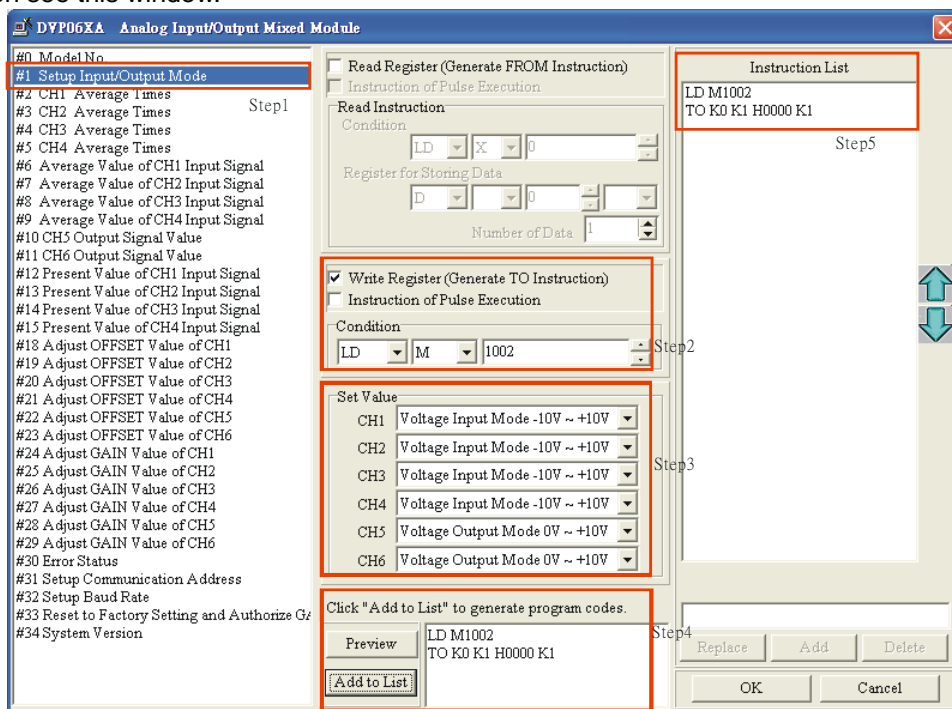

3 Mixed Analog Input/Output Module DVP06XA-E2

- Next, let's take 3.8.1 Speed tracing of AC motor drive as example.
Step 1: Select "#1 Set up Input/Output Mode".
Step 2: Check "Write Register" to generate TO instruction. Set the condition as "LD M1002".
Step 3: Set CH1 ~ CH4 as "Voltage Input Mode -10V ~ +10V" and CH5 ~ CH6 as "Voltage Output Mode 0V ~ +10V".
Step 4: Click "Preview" to check if the generated program codes are correct.
Step 5: Click "Add to List" to display the instruction codes in "Instruction List". The setup of CR#1 is completed.

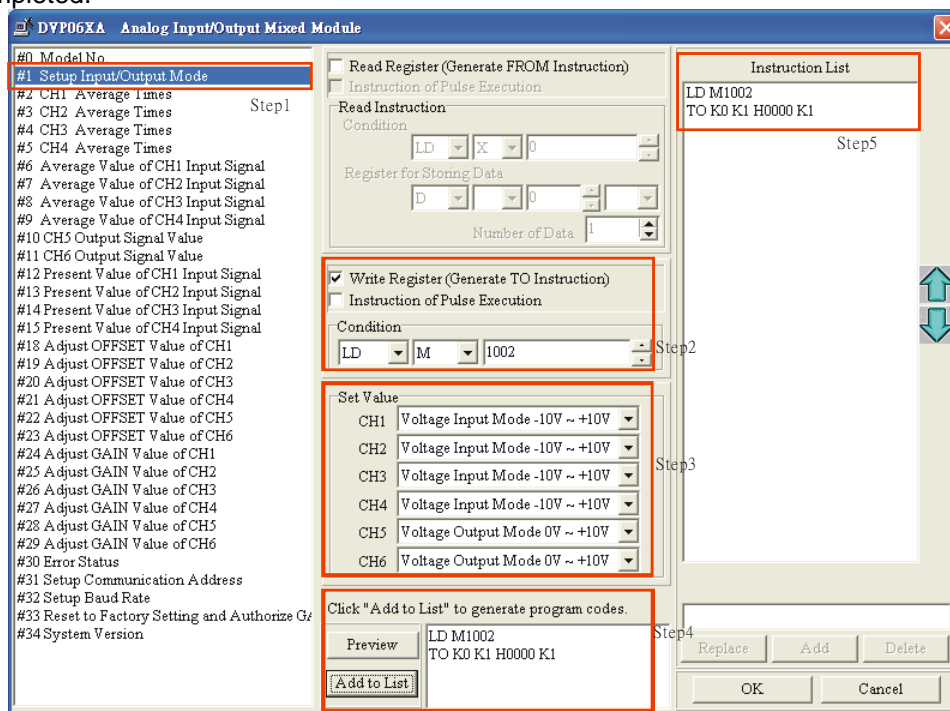

- Setting up CR#2 is similar to the setup of CR#1.
Step 1: Select "#2 CH1 Average Times".
Step 2: Check "Write Register" to generate TO instruction. Set the condition as "LD M1002".
Step 3: Set the set value as "K10" and number of data as "1".
Step 4: Click "Preview" to check if the generated program codes are correct.
Step 5: Click "Add to List" to display the instruction codes in "Instruction List". The setup of CR#2 is completed.

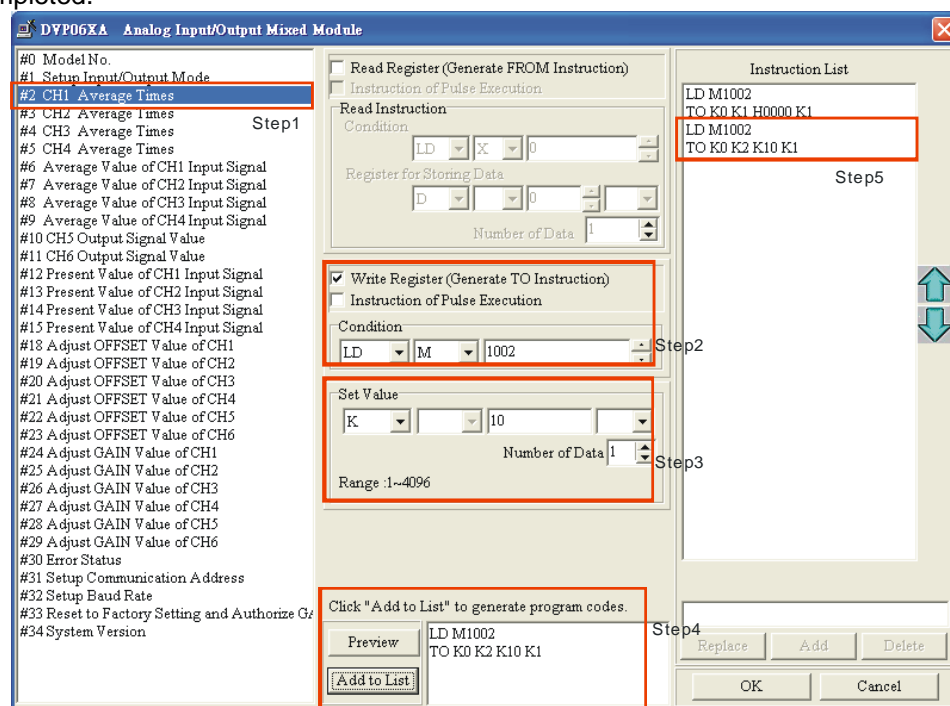

- The setup of other CR parameters can follow the steps illustrated above.

3 Mixed Analog Input/Output Module DVP06XA-E2

7. After you complete all the setups, click on "OK" to return to the "Auxiliary Design of Extension Module" window and continue to set up other modules.

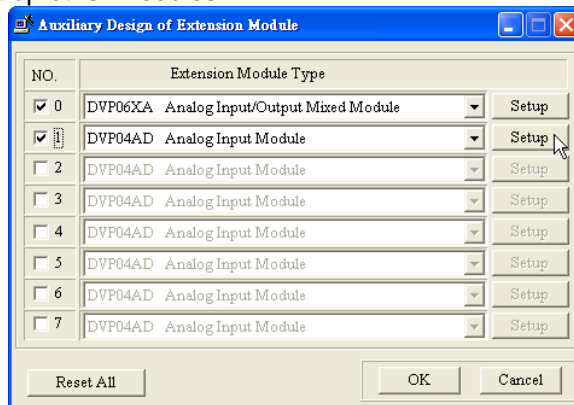

8. After you complete the setups of all the modules, click on "OK" to generate the program below.

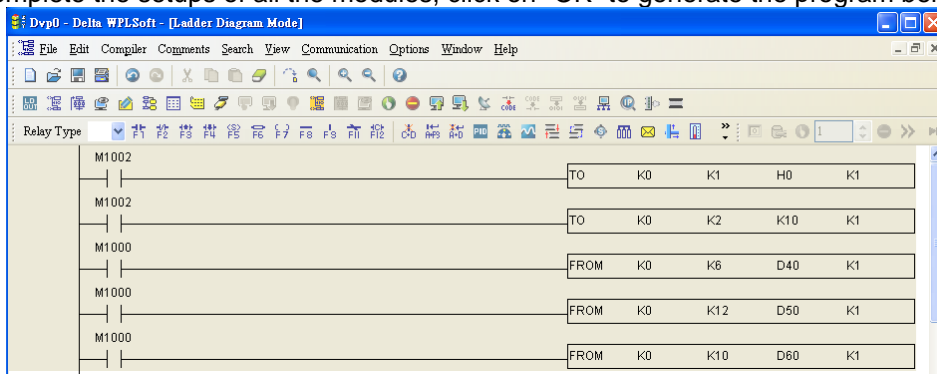

9. If you need to add in other control programs, you can edit the program directly in the ladder diagram window in WPLSoft.

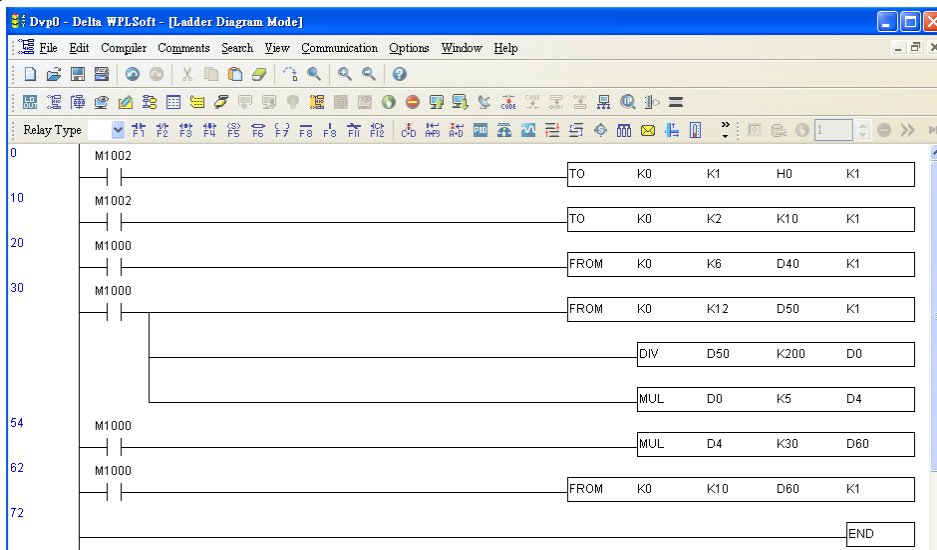

MEMO

4 Temperature Measurement Module DVP04PT-E2

4.1 The Basic Concept of Platinum Temperature Sensor

Platinum temperature sensor is highly accurate and stable and the quality of linearity between -200°C and 600°C is fairly good. Take PT100 for example. Generally the temperature coefficient of PT100 temperature sensor is more significant at low temperature -200°C ~ -100°C while it becomes small at high temperature, i.e. 300°C ~ 500°C. In addition, the quality of linearity is good at middle temperature 100°C ~ 300°C. The resistance of PT100 is 100Ω at 0°C, which is taken as the standard for a metallic temperature sensor.

In order to reduce self-heating, a working current that is too big should be avoided in the application of PT100 temperature sensor. Generally we confine the rated current to be below 2mA. The self-heating of 1mW on PT100 will cause a temperature variation of 0.02°C ~ 0.75°C. Reducing the current through PT100 will reduce the temperature variation as well. However, if the current is too small, PT100 will be interfered by noise easily. Therefore, it is appropriate to confine the current between 0.5mA and 2mA.

4.2 Introduction

DVP04PT-E2 temperature measurement module is able to receive 4 points of platinum temperature sensors (PT100 3-WIRE 100Ω 3850 PPM/°C (DIN 43760 JIS C1604-1989)/ NI100 / PT1000 / NI1000) and convert them into 16-bit digital signals. The data in DVP04PT can be read/written by using FROM/TO instructions or D9900 ~ D9999 in the program of DVP-PLC MPU. You can select the temperature to be displayed in Celsius (°C) or Fahrenheit (°F). Resolution of temperature in Celsius: 0.1°C and in Fahrenheit: 0.18°F.

4.3 Product Profile and Outline

4.3.1 DVP04PT-E2

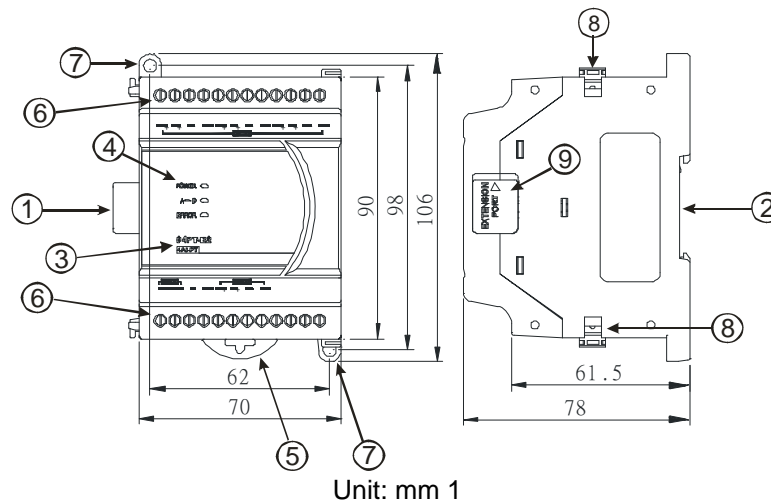

1. Connection port for extension unit/module	6. Terminals
2. DIN rail (35mm)	7. Mounting hole
3. Model name	8. Fixing clip for extension unit/module
4. POWER, ERROR, A→D indicators	9. Mounting port for extension unit/module
5. DIN rail clip	

I/O terminals

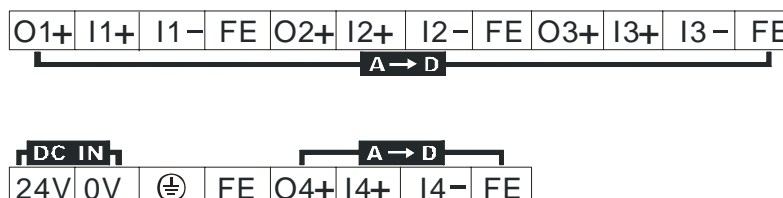

4 Temperature Measurement Module DVP04PT-E2

4.4 External Wiring

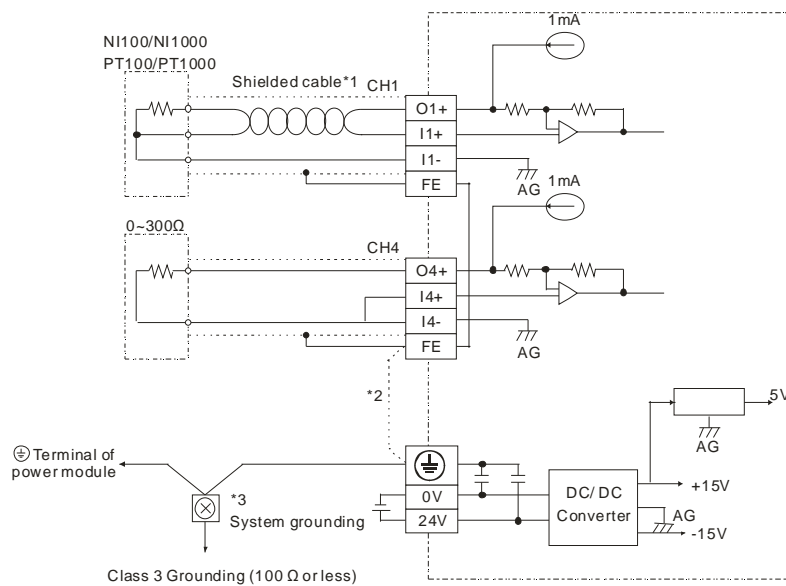

- *1: Wiring for analog input should adopt cables of PT100 / PT1000 temperature sensor or double shielded cable and should be separated from other power cables that may cause interference. Please apply 3 wires for PT100 / PT1000. If a 2 wires sensor is applied, please short-circuit I+ and I- terminals.
- *2: Connect FE with \oplus terminal for noise suppression.
- *3: Connect the \oplus terminal on both power module and DVP04PT-E2 to the system grounding point then ground the point or connect it to the cover of power distribution cabinet.

4.5 Functions and Specifications

DVP04PT-E2	Celsius (°C)	Fahrenheit (°F)	Input Impedance
Power supply voltage	24V DC (20.4V DC ~ 28.8V DC) (-15% ~ +20%)		
Connector	European standard removable terminal block (Pin pitch: 5mm)		
Analog input channel	4 channels		
Applicable sensor type	3-WIRE PT100 / NI100 / PT1000 / NI1000, 0~300Ω input impedance		
Current excitation	1.53mA(PT100/NI100), 200uA (PT1000/NI1000)		
Range of input	PT100: -180°C ~ 800°C NI100: -80°C ~ 170°C PT1000: -180°C ~ 800°C NI1000: -80°C ~ 170°C	PT100: -292°F ~ 1472°F NI100: -112°F ~ 338°F PT1000: -292°F ~ 1472°F NI1000: -112°F ~ 338°F	0~300Ω
Range of digital conversion	PT100: K-1,800 ~ K8,000 NI100: K-800 ~ K1,700 PT1000: K-1,800 ~ K8,000 NI1000: K-800 ~ K1,700	PT100: K-2920 ~ K14720 NI100: K-1120 ~ K3380 PT1000: K-2920 ~ K14720 NI1000: K-1120 ~ K3380	0~3000
Resolution	16 bits (0.1°C)	16 bits (0.18°F)	16 bits (0.1Ω)
Overall accuracy	±0.3% when in full scale (25°C, 77°F) ±0.6% when in full scale within the range of 0 ~ 55°C, 32 ~ 131°F		
Response time	1.6 sec / all channels		
Isolation	Optical coupler isolation between digital circuits and analog circuits. No isolation among analog channels. 500VDC between digital circuits and Ground 500VDC between analog circuits and Ground 500VDC between analog circuits and digital circuits 500VDC between 24VDC and Ground		
Digital data format	16 significant bits are available; in 2's complement.		
Average function	Supported. Available for setting up average times in CR#8 ~ CR#11. Range: K1 ~ K100.		
Self-diagnosis	Upper and lower bound detection in all channels		
Series connection to DVP-PLC MPU	The modules are numbered from 0 to 7 automatically by their distance from MPU. No.0 is the closest to MPU and No.7 is the furthest. Maximum 8 modules are allowed to connect to MPU and will not occupy any digital I/O points.		

4 Temperature Measurement Module DVP04PT-E2

DVP04PT-E2	Celsius (°C)	Fahrenheit (°F)	Input Impedance
Temperature/digital curve (Default: Mode 0)	Mode 0 (H'0000): PT100, °C Mode 2 (H'0002): PT1000, °C Digital output 	Mode 0 (H'0000): PT100, °F Mode 2 (H'0002): PT1000, °F Digital output 	
	Mode 1 (H'0001): NI 100, °C Mode 3 (H'0002): NI 1000, °C Digital output 	Mode 1 (H'0001): NI 100, °F Mode 3 (H'0002): NI 1000, °F Digital output 	
	Mode 4 (H'0004): 0~300 Ω Digital output 	Mode -1 (H'FFFF): Channel unavailable. Average value and present value of input channels will be displayed as 32,767(H'7FFF)	
Operation/storage	1. Operation: 0°C ~ 55°C (temperature), 50 ~ 95% (humidity), pollution degree 2 2. Storage: -25°C ~ 70°C (temperature), 5 ~ 95% (humidity)		
Vibration/shock immunity	International standards: IEC61131-2, IEC 68-2-6 (TEST Fc)/IEC61131-2 & IEC 68-2-27 (TEST Ea)		
Power Supply			
Max. rated power consumption	24V DC (20.4V DC ~ 28.8V DC) (-15% ~ +20%), 3W, supplied by external power source		

4.6 CR (Control Register)

4.6.1 CR in DVP04PT-E2

DVP04PT-E2				Description
CR#	Save	R	Register content	
#0	YES	R	Model name	Set up by the system: DVP04PT-E2 model code = H'0082
#1	YES	R	Firmware version	Display the current firmware version in hex.
#2	YES	R/W	CH1 Input mode setting	Input mode: Default = H'0000. Take CH1 for example: Mode 0 (H'0000): PT100: -180°C ~ 800°C Mode 1 (H'0001): NI100: -80°C ~ 170°C Mode 2 (H'0002): PT1000: -180°C ~ 800°C Mode 3 (H'0003): NI1000: -80°C ~ 170°C Mode 4 (H'0004): 0~300Ω. Mode -1 (H'FFFF): Channel 1 unavailable
#3	YES	R/W	CH2 Input mode setting	
#4	YES	R/W	CH3 Input mode setting	
#5	YES	R/W	CH4 Input mode setting	
#6			Reserved	
#7	YES	R/W	Temperature unit setting	Select the temperature unit (Celsius °C / Fahrenheit °F). Default = H0(C)
#8	YES	R/W	CH1 average times	Set average times at CH1 ~ CH4 Range = K1 ~ K100 Default = K10
#9	YES	R/W	CH2 average times	
#10	YES	R/W	CH3 average times	
#11	YES	R/W	CH4 average times	
#12	NO	R	Average temperature measured at CH1	Average temperature measured at CH1 ~ CH4. Temperature unit: set in CR#7
#13	NO	R	Average temperature measured at CH2	
#14	NO	R	Average temperature measured at CH3	
#15	NO	R	Average temperature measured at CH4	
#16 ~ #19			Reserved	

4 Temperature Measurement Module DVP04PT-E2

DVP04PT-E2				Description	
CR#	Save		Register content		Description
#20	NO	R	Present temperature measured at CH1		
#21	NO	R	Present temperature measured at CH2		
#22	NO	R	Present temperature measured at CH3		
#23	NO	R	Present temperature measured at CH4		
#24 ~ #27			Reserved		
#28	YES	R/W	Adjusted Offset value of CH1		Set the adjusted Offset value of Ch1 ~ Ch4. Default = K0 Range: K-400~K400 Definition of Offset at Ch1 ~ Ch4 in DVP04PT-E2: Deviation digital value from the target temperature/voltage.
#29	YES	R/W	Adjusted Offset value of CH2		
#30	YES	R/W	Adjusted Offset value of CH3		
#31	YES	R/W	Adjusted Offset value of CH4		
#32 ~ #39			Reserved		
#40	YES	R/W	Function: Set value changing prohibited		Prohibit set value changing in CH1 ~ CH4
#41	NO	R/W	Function: Save all the set values		Save all the set values, Default =H'0000
#42	NO	R/W	Function: Return to default setting		Set all values to default setting, Default = H'0000
#43	NO	R	Error status		Register for storing all error status. See the table of error status for more information.
#44 ~ #99			Reserved		
#100	YES	R/W	Function: Enable/Disable limit detection		Enable/Disable the upper and lower bound detection function
#101	NO	R/W	Upper and lower bound status		Display the upper and lower bound value, Default =H'0000
#102	YES	R/W	Set value of CH1 upper bound		Set value of CH1~CH4 upper bound. Default = K32,000
#103	YES	R/W	Set value of CH2 upper bound		
#104	YES	R/W	Set value of CH3 upper bound		
#105	YES	R/W	Set value of CH4 upper bound		
#106 ~ #107			Reserved		
#108	YES	R/W	Set value of CH1 lower bound		Set value of CH1~CH4 lower bound. Default = K-32,000
#109	YES	R/W	Set value of CH2 lower bound		
#110	YES	R/W	Set value of CH3 lower bound		
#111	YES	R/W	Set value of CH4 lower bound		
#112 ~ #119			Reserved		

DVP04PT-E2						Description	
CR#				Save	Register content		Description
CH1	CH2	CH3	CH4				
#120	#140	#160	#180	YES	R/W	SV (Setpoint)	Please set the temperature value according to proper range of each sensor type. Default = K0
#121	#141	#161	#181	YES	R/W	Sampling time (s)	Range: K1 ~ K30 (s). Default = K2
#122	#142	#162	#182	YES	R/W	K _P	Proportional control constant. Default = K121
#123	#143	#163	#183	YES	R/W	K _I	Integral constant. Default = K2,098
#124	#144	#164	#184	YES	R/W	K _D	Derivative constant. Default = K-29.
#125	#145	#165	#185	YES	R/W	Upper limit of I value	Upper limit of I value. Default = K0
#126	#146	#166	#186	YES	R/W	Lower limit of I value	Lower limit of I value. Default = K0.
#127	#147	#167	#187	NO	R	I value	Current accumulated offset value.
#128	#148	#168	#188	YES	R/W	Heating/cooling	0: Heater, 1: Cooler. Default = K0
#129	#149	#169	#189	YES	R/W	Upper limit of output	Upper limit of output. Default = K32,000
#130	#150	#170	#190	YES	R/W	Lower limit of output	Lower limit of output. Default = K0
#131	#151	#171	#191	NO	R	Output percentage (%)	Output percentage (Unit: 0.1%)
#132	#152	#172	#192	NO	R	Output width (ms)	Width of control output. Unit: ms.
#133	#153	#173	#193	NO	R	Output cycle (ms)	Cycle of control output. Unit: ms.
#134	#154	#174	#194	NO	R	Output volume	Output volume
#135	#155	#175	#195	NO	R/W	PID_RUN/STOP	0: STOP, 1: RUN. Default = K0
#136	#156	#176	#196	NO	R/W	Auto-tuning	0: Disabled, 1: Auto-tuning. Default = K0

Symbols:

YES: When CR#41 is set to H'5678, the set value of CR will be saved. NO: Set value will not be saved

R: Able to read data by FROM instruction, W: Able to write data by using TO instructions

4.6.2 Explanation on CR

CR#0: Model name

[Explanation]

1. DVP04PT-E2 model code = H'0082.
2. You can read the model name in the program to see if the extension module exists.

CR#1: Firmware version

[Explanation]

Display the current firmware version in hex, e.g. version V1.00 is indicated as H'0100.

CR#2, 3, 4, 5: CH1 ~ CH4 input mode setting

[Explanation]

Set the working mode of the input channels of the analog input module. There are 6 modes for each channel which can be set up separately.

When you set CH1 as mode 1 (H'0001) CR#2 has to be set as H'0001. The default setting = H'0000. Take CH1 as example::

Mode 0 (H'0000): PT100 (-180°C ~ 800°C).

Mode 1 (H'0001): NI100 (-80°C ~ 170°C).

Mode 2 (H'0002): PT1000 (-180°C ~ 800°C).

Mode 3 (H'0003): NI1000 (-80°C ~ 170°C).

Mode 4 (H'0004): 0~300Ω.

Mode-1 (H'FFFF): Channel 1 unavailable.

CR#7: Temperature unit setting

[Explanation]

Select the temperature unit of average temperature and present temperature. (Celsius °C / Fahrenheit °F).

Default = H'0000.

Mode 0 (H'0000): Celsius °C.

Mode 1 (H'0001): Fahrenheit °F.

CR#8, 9, 10, 11: CH1 ~ CH4 average times

[Explanation]

1. The average times of the signals at CH1 ~ CH4.
2. Setup range for DVP04PT-E2: K1 ~ K100. Default = K10. If the set value exceeds K100, the value will be set as K100; if the set value is lower than K1, the set value will be set as K1

CR#12, 13, 14, 15: Average temperature measured at CH1 ~ CH4

[Explanation]

The average temperature measured at CH1 ~ CH4 is calculated according to the average times set in CR#8 ~ CR#11. Temperature unit: set in CR#7. For example, if the average times is set as K10, the contents in CR#12 ~ CR#15 will be the average of the most recent 10 temperature signals in CH1 ~ CH4.

CR#20, 21, 22, 23: Present temperature measured at CH1 ~ CH4

[Explanation]

Display the present temperature at CH1 ~ CH4. Temperature unit: set in CR#7.

4 Temperature Measurement Module DVP04PT-E2

CR#28, 29, 30, 31: Adjusted Offset value of CH1 ~ CH4

[Explanation]

1. Set the adjusted Offset value of CH1 ~ CH4.
2. Range: K-400~K400
3. Default setting = K0.

Definition of Offset at Ch1 ~ Ch4 in DVP04PT-E2:

Deviation digital value from the target temperature/voltage

Mode 0 ~ Mode 3:

Equation:

$$Y = \left(\frac{X(^{\circ})}{0.1(^{\circ})} - Offset \right)$$

Y = digital output, X = measured input temperature

Mode 4:

Equation:

$$Y = \left(\frac{X(\text{Ohm})}{0.1(\text{Ohm})} - Offset \right)$$

Y = digital output, X = measured input impedance

CR#40: Function: Set value changing prohibited, Default = H'0000

[Explanation]

Description	
bit0	b0=0, CH1 changing allowed; b0=1, CH1 changing prohibited
bit1	b1=0, CH2 changing allowed; b1=1, CH2 changing prohibited
bit2	b2=0, CH3 changing allowed; b2=1, CH3 changing prohibited
bit3	b3=0, CH4 changing allowed; b3=1, CH4 changing prohibited
bit4 ~ bit15	Reserved
Relative Parameters	
CR#2 ~ CR#5	Input mode setting at CH1 ~ CH4
CR#8 ~ CR#11	Average times at CH1 ~ CH4
CR#28 ~ CR#31	Offset settings at CH1 ~ CH4
CR#42	Returning to default setting
CR#100	Function: Enable/Disable limit detection
CR#102~CR#105	Set value of CH1~CH4 upper bound
CR#108~CR#111	Set value of CH1~CH4 lower bound
CR#120~CR#196	PID relative settings

CR#41: Function: Save all the set values. Default=H'0000

[Explanation]

Save function setting. Save all the set values to the internal flash memory. When saving is completed, CR#41 will be set to H'FFFF.

Set value	Function
H0	No action
HFFFF	Saving completed
H5678	Saving enabled.

Note: Default setting = H0. When set value = H'5678, saving will be enabled, and CR#41 will be set to H'FFFF when saving is completed. If the set value is not H'5678, the set value will remain H'0. For example, input K1 into CR#41, and the value will remain H'0.

4 Temperature Measurement Module DVP04PT-E2

CR#42: Function: Return to default setting, Default = H'0000

[Explanation]

Description	
bit0	b0=0, no action on CH1; b0=1, set CH1 to default setting
bit1	b1=0, no action on CH2; b1=1, set CH2 to default setting
bit2	b2=0, no action on CH3; b2=1, set CH3 to default setting
bit3	b3=0, no action on CH4; b3=1, set CH4 to default setting
bit4 ~ bit15	Reserved

Note: Set designated bit as 1 and the corresponding channel will be returned to default setting. When setting is completed, the value will be set to 0. If CR#40(Set value changing prohibited) is enabled, the default setting in CR#42 will be invalid, and all set values will remain unchanged. Error Code bit 12 of CR#43 will be set to 1

Relative Parameters	
CR#2 ~ CR#5	Input mode setting at CH1 ~ CH4
CR#8 ~ CR#11	Average times at CH1 ~ CH4
CR#28 ~ CR#31	Offset settings at CH1 ~ CH4
CR#100	Function: Enable/Disable limit detection
CR#102~CR#105	Set value of CH1~CH4 upper bound
CR#108~CR#111	Set value of CH1~CH4 lower bound
CR#120~CR#196	PID relative settings

CR#43: Error status. Default=H'0000

[Explanation]

CR#43: error status value. See the table below:

Description		
bit0	K1 (H'1)	Power Supply error
bit1	K2 (H'2)	Hardware error
bit2	K4 (H'4)	Upper / lower limit error
bit3	K8 (H'8)	CH1 Conversion error
bit4	K16 (H'10)	CH2 Conversion error
bit5	K32 (H'20)	CH3 Conversion error
bit6	K64 (H'40)	CH4 Conversion error
bit7 ~ bit8		Reserved
bit9	K512(H'0200)	Mode setting error
bit10	K1024(H'0400)	Average times error
bit11	K2048(H'0800)	Upper / lower limit setting error
bit12	K4096(H'1000)	Set value changing prohibited
bit13	K8192(H'2000)	Communication breakdown on next module
bit14 ~ bit15		Reserved

 **Note:** Each error status is determined by the corresponding bit (b0 ~ b13) and there may be more than 2 errors occurring at the same time. 0 = normal; 1 = error

CR#100: Function: Enable/Disable limit detection. Default =H'0000

[Explanation]

Description	
bit0=1	Enable CH1 limit detection
bit1=1	Enable CH2 limit detection
bit2=1	Enable CH3 limit detection
bit3=1	Enable CH4 limit detection
bit4 ~ bit15	Reserved

CR#101: Upper and lower bound status. Default =H'0000

[Explanation]

Description	
bit0=1	CH1 exceeds lower bound
bit1=1	CH2 exceeds lower bound
bit2=1	CH3 exceeds lower bound

4 Temperature Measurement Module DVP04PT-E2

Description	
bit3=1	CH4 exceeds lower bound
bit4 ~ bit7	Reserved
bit8=1	CH1 exceeds upper bound
bit9=1	CH2 exceeds upper bound
bit10=1	CH3 exceeds upper bound
bit11=1	CH4 exceeds upper bound
bit12 ~ bit15	Reserved

CR#102, 103, 104, 105: Set value of CH1 ~ CH4 upper bound. Default =H'0000

[Explanation]

Set the upper bound value of CH1 ~ CH4. Default = K32,000

CR#108, 109, 110, 111: Set value of CH1 ~ CH4 lower bound. Default =H'0000

[Explanation]

Set the lower bound value of CH1 ~ CH4. Default = K-32,000

CR#120, 140, 160, 180: SV (Setpoint)

[Explanation]

1. Please set the temperature value (unit: 0.1 degree) according to proper range of each sensor type, i.e., suppose the target temperature is 100°C, write K1000 into the specified CR by using TO instruction.
2. Default = K0.

CR#121, 141, 161, 181: Sampling time (s)

[Explanation]

1. Set up the time interval between each action of sampling. If the temperature in the control environment does not vary significantly, set up longer sampling time; however if temperature varies quickly, set up shorter sampling time.
2. Setup range: 1 ~ 30, Default =K2. The conversion time of each channel in the temperature measurement module is approximately 1 second. Therefore, if the value is smaller than 1, 1 will be automatically written into the CR. If the value is bigger than 30, 30 will be written into the CR.
3. Output cycle time (ms) is equal to the setup sampling time (s), i.e. if the sampling time is set as 2, the output cycle will be 2,000 correspondingly.

CR#122, 142, 162, 182: K_P value, Default =K121

[Explanation]

K_P : The proportional control constant, i.e. proportional band. The proportional control refers to that the output is in proportional to the error. Please refer to the PID operation formula and set up an appropriate parameter.

$$\text{Output MV (\%)} = E / K_P \times 100\%$$

MV : Output value

K_P : Proportional gain

$E(t)$: Error value

Example:

Set up $K_P = 10$, $E = 1$, $K_I = 0$, $K_D = 0$ (Close K_I , K_D)

$$\text{MV (\%)} = 1 / 10 \times 100\% = 10\%$$

The output percentage displayed in CR#131, 151, 171, 191 will be 10%.

CR#123, 143, 163, 183: K_I value, Default = K2098

[Explanation]

K_I : Integral constant.

1. Suppose only proportional control is applied, there will be certain deviation between the set value and the actual temperature. If integral control is applied, the deviation will decrease gradually and the target temperature can be achieved.
2. Integral control function will be disabled if K0 is set to the CRs.
3. If the curve is too gradual, please adjust K_I . The closer the K_I to 0, the more abrupt the curve becomes.

CR#124, 144, 164, 184: K_D value, Default = K-29

[Explanation]

K_D : Derivative constant.

1. Derivative control enhances disturbance rejection and helps the control status get back to the target temperature quickly.
2. Derivative control function will be disabled if K_D is set to the CRs.
3. If the output percentage fluctuates too much, please adjust K_D . The closer K_D value to 0, the less fluctuating the output percentage will be.

CR#125, 145, 165, 185: Upper limit of I value, Default = K0

CR#126, 146, 166, 186: Lower limit of I value, Default = K0

[Explanation]

1. When both upper limit and lower limit are 0, the upper/lower limit function for I value will be closed, which means there will be no upper/lower limit for I value.
2. When the upper limit is set to be smaller than the lower limit, the upper and lower limit will be set to the same value.

CR#127, 147, 167, 187: I value

[Explanation]

Current accumulated offset value.

CR#128, 148, 168, 188: Heating/cooling

[Explanation]

Select heating or cooling control. Set the CR to “0” if your control target is a heater. Set the CR to “1” if your control target is a cooler. The default setting = H'0000.

Mode 0 (H'0000): Heater.

Mode 1 (H'0001): Cooler.

CR#129, 149, 169, 189: Upper limit of output. Default = K32,000

CR#130, 150, 170, 190: Lower limit of output. Default = K0

[Explanation]

1. The output volume is calculated from the upper limit and lower limit.
2. For example, if the upper/lower limit is set to 0 ~ 32000, when the output comes to 50%, the output volume will be 16000. Please set up this CR according to the analog output you are using.

CR#131, 151, 171, 191: Output percentage (0.1%)

[Explanation]

The result obtained from the PID operation. Unit: 0.1%. For example, if the PID operating result is 100, the output percentage will be 10%.

CR#132, 152, 172, 192: Output width (ms)

CR#133, 153, 173, 193: Output cycle (ms)

[Explanation]

If you are using the cyclic control mode to control your target, please read the two CRs. For example, if the cycle is 2,000 and width 1,000, the output pulse will shape like below:

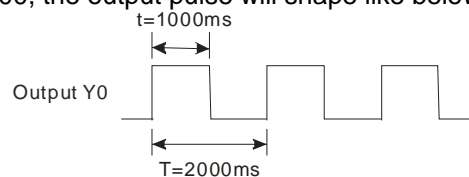

CR#134, 154, 174, 194: Output volume

[Explanation]

Formula of output volume:

$$\text{Output Volume} = (\text{Output Upper Limit} - \text{Output Lower Limit}) \times \text{Output \%} + \text{Output Lower Limit}$$

Example:

Control by current 4 ~ 20mA (0 ~ 32,000)

Output upper limit: 32,000

Output lower limit: 0

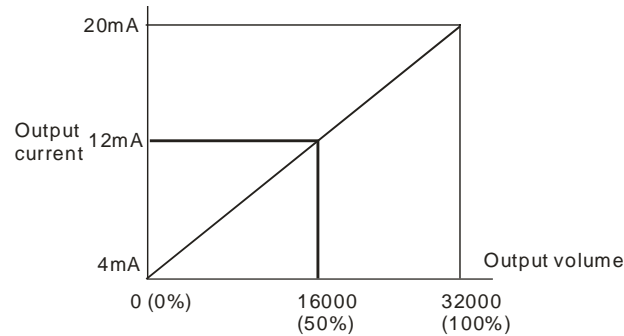

CR#135, 155, 175, 195: PID_RUN/STOP

[Explanation]

1. If you want to apply auto-tuning function, enable auto-tuning function before setting PID function as RUN. When auto-tuning is completed, CR#136, 156, 176, 196 will be cleared as 0, and the obtained value of K_P / K_I / K_D will be stored into corresponding CRs.
2. PID_RUN/STOP, K0: STOP, K1: RUN. Default = K0.

CR#136, 156, 176, 196: Auto-tuning

[Explanation]

1. If you want to apply auto-tuning function, set the auto-tuning CR to K1 to enable auto-tuning function before setting PID function as RUN. When auto-tuning is completed, CR#136, 156, 176, 196 will be cleared as 0, and the obtained value of K_P / K_I / K_D will be stored into corresponding CRs.
2. Auto-tuning, K0: Disabled, K1: Auto-tuning. Default = K0.

Note:

1. Set K_P , K_I , and K_D to "0" to disable the PID function. If you want to use proportional control only, set K_I and K_D to "0".
2. If you do not know how to tune PID parameters in your control environment, use "auto-tuning" to generate K_P , K_I and K_D and further modify them into better K_P , K_I and K_D . To utilize the auto-tuning, set the auto-tuning CR to K1. After the auto-tuning is completed, the CR will automatically return to K0.
3. If you want to fill in your own K_P , K_I and K_D , please set up K_P first according to your experiences and set K_I and K_D to "0" to disable the integral and derivative control functions. When K_P is set, modify K_I and K_D . We recommend you to adjust K_I decreasingly and K_D downwards from 0.
4. If the output percentage fluctuates too much, please adjust K_D . The closer K_D value to 0, the less fluctuating the output percentage will be. Besides, if the curve is too gradual, please adjust K_I . The closer the K_I to 0, the more abrupt the curve becomes.

4 Temperature Measurement Module DVP04PT-E2

4.6.3 Explanation on Special Registers D9900~D9999

When ES2 MPU is connected with modules, registers D9900~D9999 will be reserved for storing values from modules. You can apply MOV instruction to operate values in D9900~D9999.

When ES2 MPU is connected with DVP04PT-E2, the configuration of special registers is as below:

Module#0	Module#1	Module#2	Module#3	Module#4	Module#5	Module#6	Module#7	Description
D1320	D1321	D1322	D1323	D1324	D1325	D1326	D1327	Model code
D9900	D9910	D9920	D9930	D9940	D9950	D9960	D9970	CH1 average temperature
D9901	D9911	D9921	D9931	D9941	D9951	D9961	D9971	CH2 average temperature
D9902	D9912	D9922	D9932	D9942	D9952	D9962	D9972	CH3 average temperature
D9903	D9913	D9923	D9933	D9943	D9953	D9963	D9973	CH4 average temperature

- D9900~D9999 are average input values of CH1 ~ CH4 and the average times is K1~K100. When the average times is set to K1, the values displayed in D9900~D9999 are current values. You can use: 1. ES_AIO Configuration Function of WPLSoft (refer to **4.8 Applications** in this manual) or 2. FROM/TO instructions (CR#8~CR#11) to set the average times as K1

- Example:

Ladder diagram:

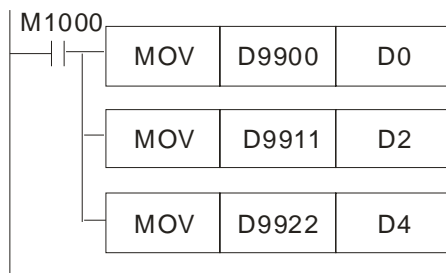

Explanation:

Save CH1 average temperature of Module#0 to D0

Save CH2 average temperature of Module#1 to D2

Save CH3 average temperature of Module#2 to D4

4.7 Temperature Conversion in DVP04PT-E2

You can adjust the conversion curves according to the actual needs by changing the Offset value (CR#28 ~ CR#31).

Definition of Offset in DVP04PT-E2:

Deviation digital value from the target temperature/voltage

- For temperature input Mode 0~3: $1_{SCALE} = 0.1^{\circ}$.

Equation:

$$Y = \left(\frac{X(^{\circ})}{0.1(^{\circ})} - Offset \right)$$

Y=Digital output, X= Measured input

- For input impedance Mode 4: $1_{SCALE} = 300\Omega/3,000 = 0.1 \text{ Ohm}$.

Equation:

$$Y = \left(\frac{X(\text{Ohm})}{0.1(\text{Ohm})} - Offset \right)$$

Y=Digital output, X=Input impedance

4 Temperature Measurement Module DVP04PT-E2

4.7.1 Conversion Curve

1. Mode 0 (H'0000): PT100 mode °C (°F) / Mode 2 (H'0002): PT1000 mode °C (°F)

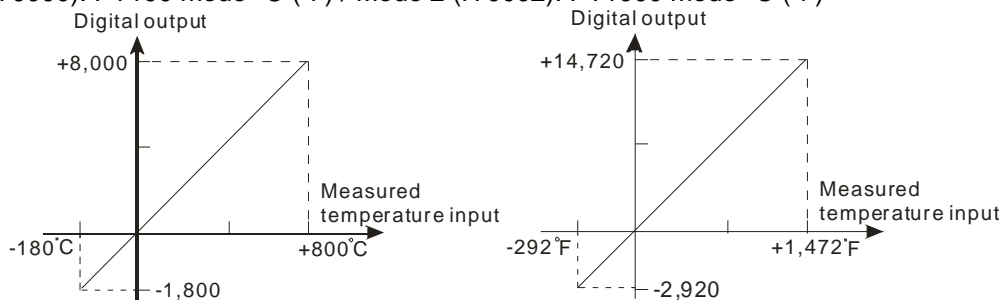

Mode 0, 2 of CR#2~ CR#5	-180°C ~ 800°C (-1800~8000), -292°F ~ 1472°F (-2920~14720)
Offset (CR#34 ~ CR#37)	Offset value

2. Mode 1 (H'0001): NI100 mode °C (°F) / Mode 3 (H'0003): NI1000 mode °C (°F)

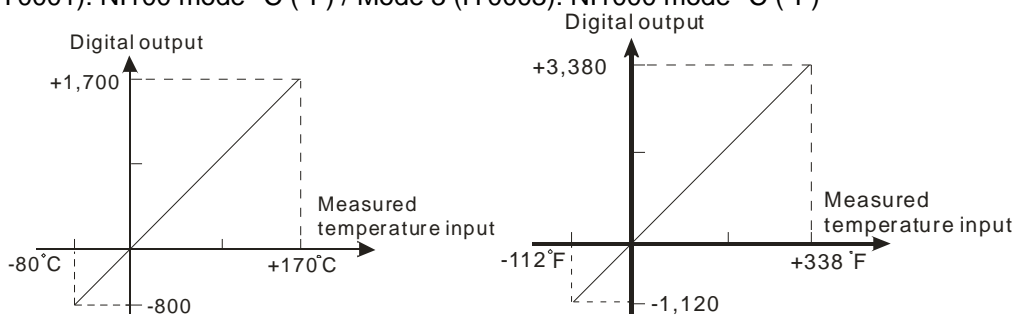

Mode 1, 3 of CR#2~ CR#5	-80°C ~ 170°C (-800~1700), -112°F ~ 338°F (-1120~3380)
Offset (CR#34 ~ CR#37)	Offset value

3. Mode 4 (H'0004): 0~300 Ω

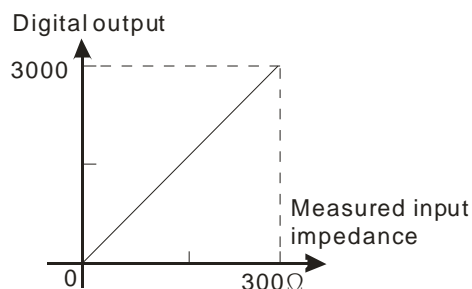

Mode 4 of CR#2~ CR#5	0 ~ 300Ω (0~3000)
Offset (CR#34 ~ CR#37)	Offset value

4.7.2 Adjusting PT Conversion Curve

1. Description

- If there is certain deviation in the measurement results, you can make adjustments on the Offset value to modify the conversion curve according to your actual needs. For example, if the deviation temperature from the target temperature (measured temperature) is 2°C, set the Offset of CH1 as 20 (2°C / 0.1°C = 20).

$$Y = \left(\frac{X(^{\circ}\text{C})}{0.1(^{\circ}\text{C})} - \text{Offset} \right)$$

Y=Digital output, X= Measured input

Example: If X= 2°C, Y=?

$$Y = \left(\frac{2(^{\circ}\text{C})}{0.1(^{\circ}\text{C})} - 20 \right) = 0$$

- You only need to set up the PT conversion curve for once. Set up CR#40 (Set value changing prohibited) to prevent incorrect operations.

2. Adjusted Curve

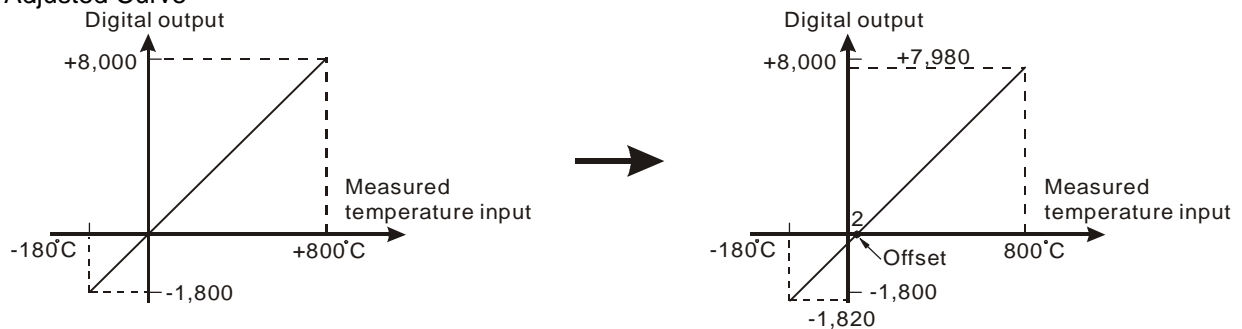

3. Devices

- X0 = On: Set the input mode of the signals at CH1 as mode 0.
- X1 = On: Set Offset value of CH1 as 20 (2°C).
- M0 = On: Disable CH1 set value changing.

4. Program explanation

- When X0 = On, set CR#2 as K0 (H'0000), i.e. the signal input mode at CH1 is mode 0 (PT100 mode).
- When X1 = On, write K20 (Offset value of CH1) into CR#28.
- When X1 goes from On to Off, set M0 = On to disable the adjustment on PT conversion curve. Write K1 (H'1) into CR#40 b0=1 to disable CH1 set value changing

5. Program example



4.8 Applications

4.8.1 PT100 Temperature Measurement System

1. Description

- Measuring temperature by PT100 temperature sensor.

2. Devices

- M0: set the average times.
- M1: switch the temperature unit of average and present temperature
- D20 ~ D23: average Celsius temperature at CH1 ~ CH4
- D30 ~ D33: average Fahrenheit temperature at CH1 ~ CH4

4 Temperature Measurement Module DVP04PT-E2

- D40 ~ D43: present Celsius temperature at CH1 ~ CH4
 - D50 ~ D53: present Fahrenheit temperature at CH1 ~ CH4
3. Program explanation
- M0=Off, set the average times of input signals at CH1 ~ CH4 as 10; M0=On set the average times of input signals at CH1 as 1.
 - M1=Off, temperature unit = °C; M1=On temperature unit = °F.
 - M0=Off, M1=Off, store the average Celsius temperature at CH1 ~ CH4 into D20 ~ D23.
 - M0=Off, M1=On, store the average Fahrenheit temperature at CH1 ~ CH4 into D30 ~ D33.
 - M0=On, M1=Off, store the present Celsius temperature at CH1 ~ CH4 into D40 ~ D43.
 - M0=On, M1=On, store the present Fahrenheit temperature at CH1 ~ CH4 into D50 ~ D53.
 - DVP04PT-E2 stores the obtained temperature value to special registers. Therefore, you only need to read the content in the special registers to obtain the measured temperature. Unit of temperature: 0.1°C or 0.1°F.

4. Program example

Ladder diagram:

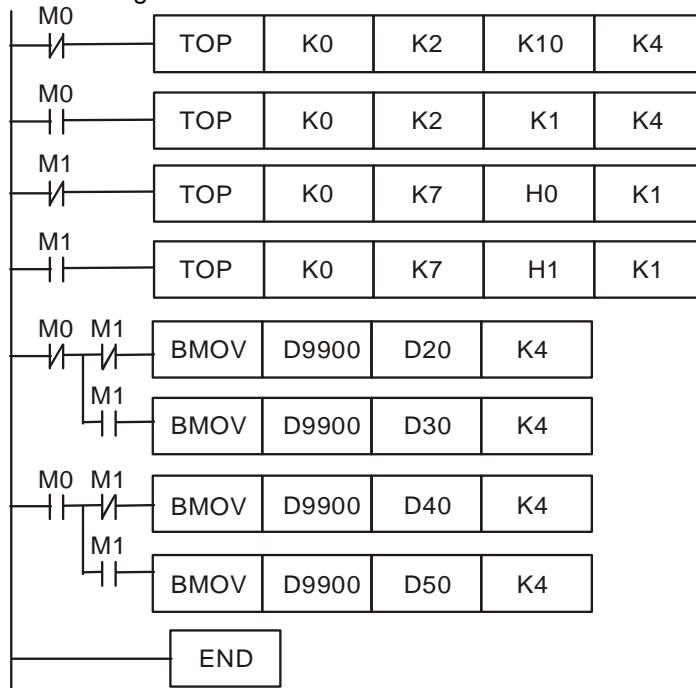

Explanation:

- Set the average times at CH1 ~ CH4 as 10
- Set the average times at CH1 ~ CH4 as 1
- Display Celsius degrees (°C)
- Display Fahrenheit degrees (°F)
- Read average Celsius degrees at CH1 ~ CH4
- Read average Fahrenheit degrees at CH1 ~ CH4
- Read present Celsius temperature at CH1 ~ CH4
- Read present Fahrenheit temperature at CH1 ~ CH4

4.8.2 How to Set the Module Wizard in WPLSoft

1. Open WPLSoft and click on .



2. You will see the "Auxiliary Design of Extension Module" window. Click on NO. "0" and select "DVP04PT Temperature Measurement Module".

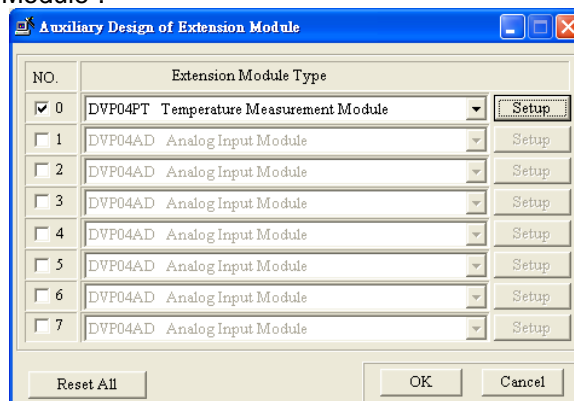

4 Temperature Measurement Module DVP04PT-E2

3. You will then see this window.

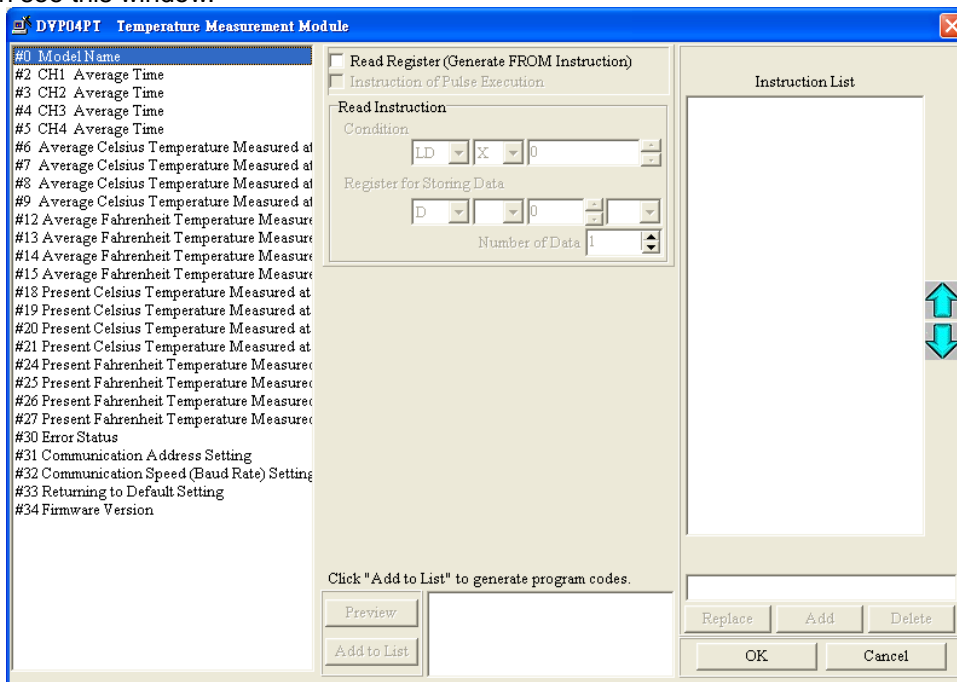

4. Next, let's take 4.7.1 PT100 temperature measurement system as example.

Step 1: Select "#2 CH1 Average times".

Step 2: Check "Write Register" to generate TO instruction. Set the condition as "LD M1002",

Step 3: Set the set value as "K10" and number of data as "4".

Step 4: Click "Preview" to check if the generated program codes are correct.

Step 5: Click "Add to List" to display the instruction codes in "Instruction List". The setup of CR#2 ~ CR#5 is completed.

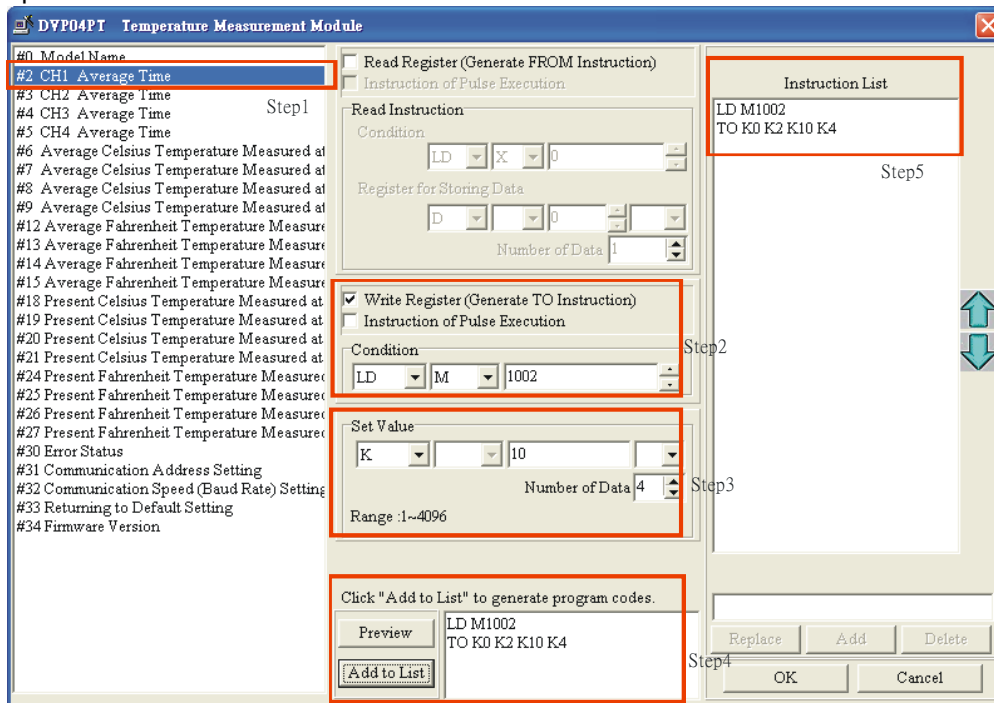

4 Temperature Measurement Module DVP04PT-E2

5. Setting up CR#6 ~ CR#9 is similar to the setup of CR#2 ~ CR#5.
 - Step 1: Select "#6 Average Celsius Temperature Measured at CH1"
 - Step 2: Check "Read Register" to generate FROM instruction. Set the condition as "LD M1000", register for storing data as "D20" and number of data as "4"
 - Step 3: Click "Preview" to check if the generated program codes are correct.
 - Step 4: Click "Add to List" to display the instruction codes in "Instruction List". The setup of CR#6 ~ CR#9 is completed.

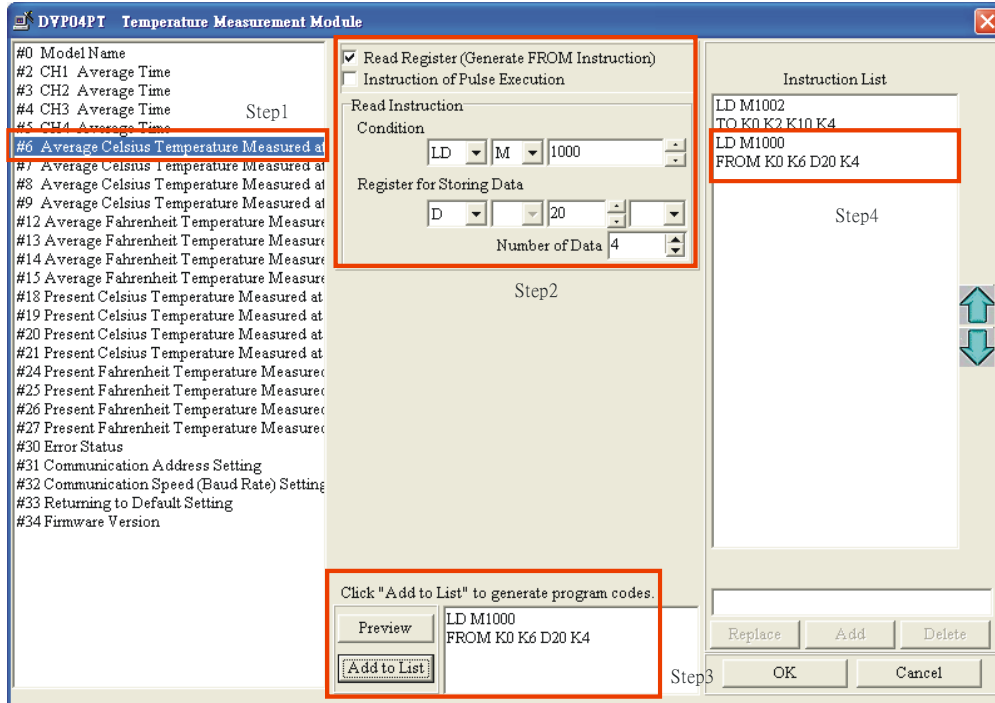

6. The setup of other CR# parameters can follow the steps illustrated above.
7. After you complete all the setups, click on "OK" to return to the "Auxiliary Design of Extension Module" window and continue to set up other modules.

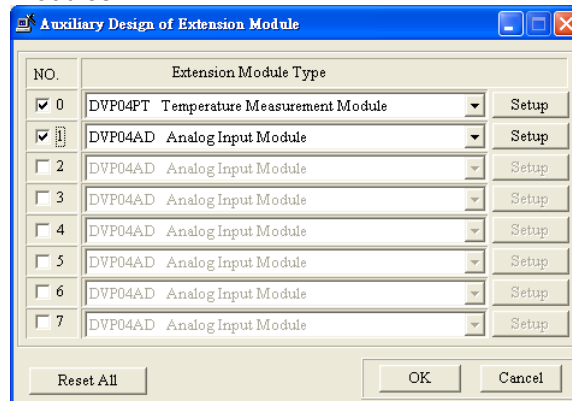

8. After you complete the setups of all the modules, click on "OK" to generate the program below.

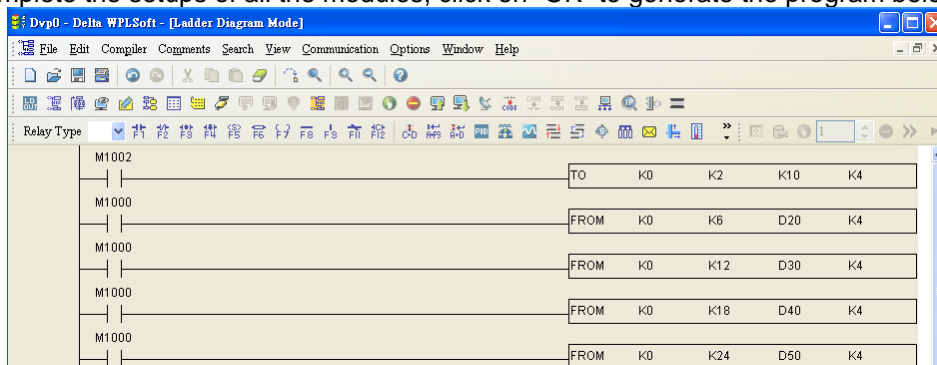

9. If you need to add in other control programs, you can edit the program directly in the ladder diagram window in WPLSoft.

4.9 PID Functions

4.9.1 Introduction to PID

- P (Proportional) Control

The proportional control refers to that the output is in proportional to the error. When the temperature is lower than the proportional band and the output is 100%, the control will enter the proportional band and the output will be gradually in smaller proportional to the error. When the set temperature value (SV) is consistent with the present temperature value (PV), i.e. no error, the output will be 0%. (Error = SV - PV)

In a heater: SV = 1,000 (100°C), $K_p = 100$ (10°C). See the figure below for the relation between temperature and output.

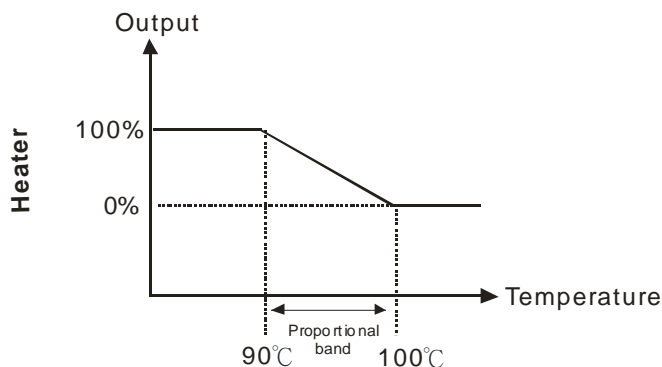

In a cooler: SV = 200 (20°C), $K_p = 100$ (10°C). See the figure below for the relation between temperature and output.

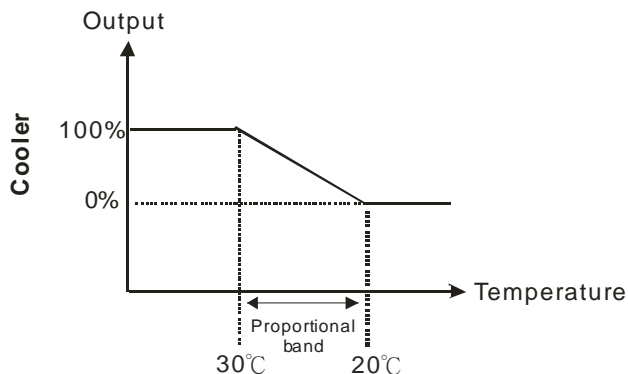

- I (Integral) Control

With only P control, the controlled temperature will be deviated in a certain level from the set temperature. Therefore, we adopt integral control with the proportional control. As time passes by, the deviation of value will disappear, and the controlled temperature will be consistent with the set temperature.

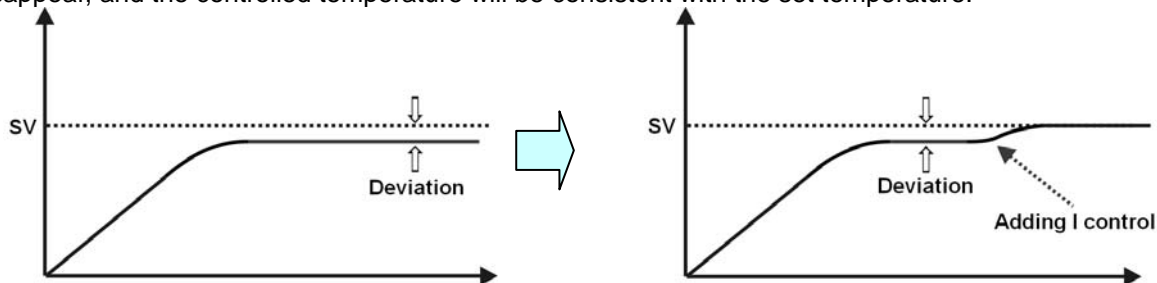

4 Temperature Measurement Module DVP04PT-E2

- D (Derivative) Control
The derivative control is capable of offering bigger output in response to strong interference and restoring the control to its original status.

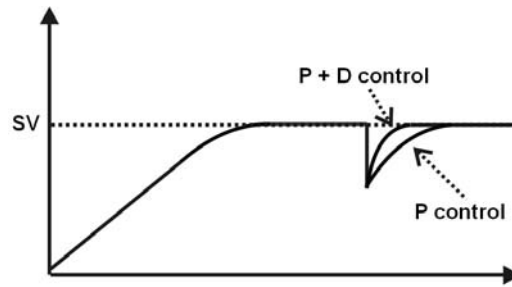

- Control Chart

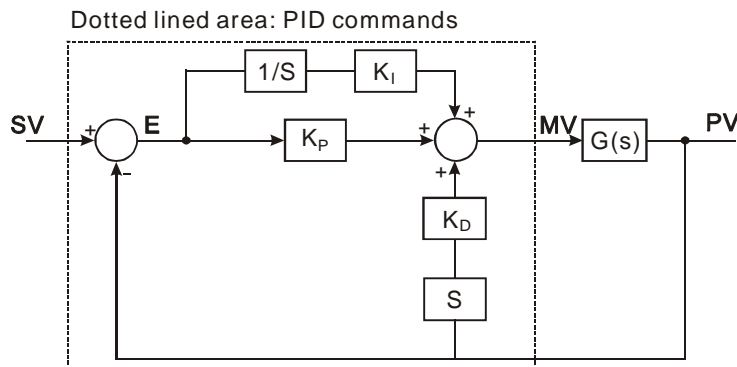

Symbol explanation:

MV : Output value

K_p : Proportional gain

$E(t)$: Error value

PV : Present measured value

SV : Target value

K_D : Differential gain

$PV(t)S$: Differential value of $PV(t)$

K_I : Integral gain

$E(t)\frac{1}{S}$: Integral value of $E(t)$

Basic PID Operation Formula

$$MV = \frac{1}{K_p} \left[E(t) + \frac{1}{K_I} \left(E(t) \frac{1}{S} \right) + K_D * PV(t)S \right]$$

In which the error is fixed to: $E = SV - PV$

To avoid the sudden derivative value that is too big caused by the activation of PID command for the first time, we therefore adopt the differentiation of PV .

4.9.2 PID Control Modes

DVP04PT-E2 offers 3 types of control modes for the PID control.

1. Percentage Control Mode (CR: output percentage)

Application 1:

If the heater or cooler you are using is controlled by a power switch (On/Off), you can read out the output percentage (0~100%) from DVP04PT-E2 and adopt GPWM instruction as a cyclic control. Please refer to the wiring method below:

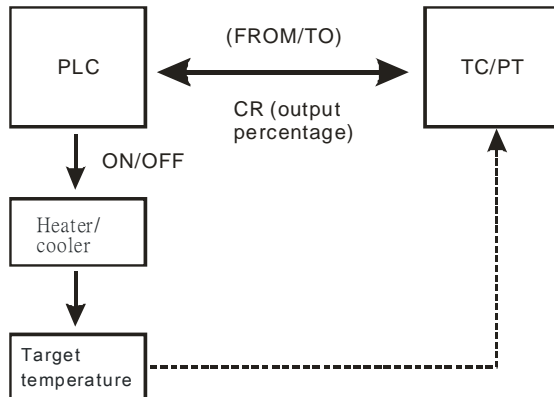

Example:

Connect the sensor to CH1 of DVP04PT-E2 and use FROM instruction to read the output percentage (CR#131). Connect the heater/cooler with Y0 and apply GPWM instruction to control the cyclic output.

PLC program description:

1. Read CR#131 (CH1 output percentage)
2. If output percentage D10=500 and output cycle D20=2000, width of output pulse D22 (t)=output cycle(T) × CR#131 / 1000 (unit: 0.1%) = D20 × D10 / 1000 = 2000 × 500/1000=1000
3. Apply GPWM instruction to control the output pulse width and output cycle so as to control the connected heater/cooler.
4. Program:

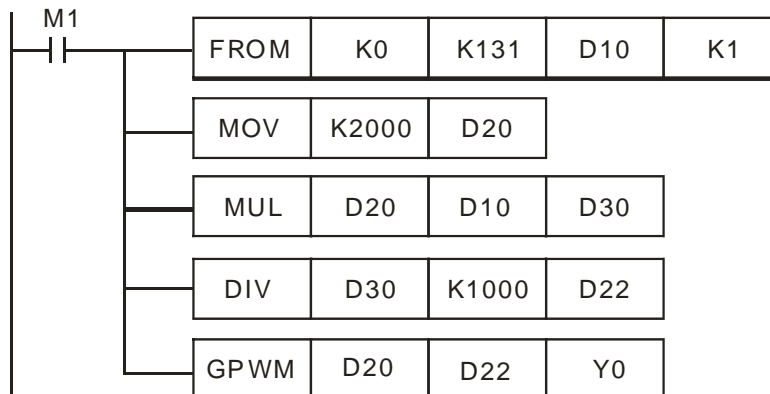

5. Diagram of output pulse:

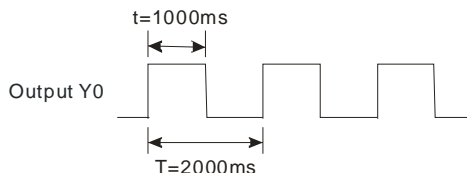

4 Temperature Measurement Module DVP04PT-E2

Application 2:

If the heater or cooler you are using is controlled by voltage or current, you can read out the output percentage (0~100%) from DVP04PT-E2 and adopt analog output function provided by DVP04DA-E2. Please refer to the wiring method below:

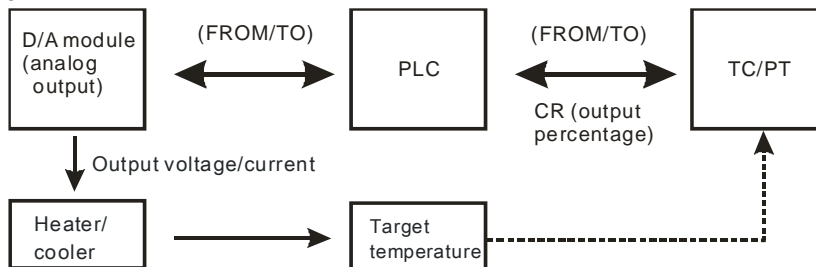

Example:

Connect the sensor to CH1 of DVP04PT-E2 and couple PLC with analog output module DVP04DA-E2. Connect the heater/cooler with voltage/current output channel of DVP04DA-E2. Output range of heater/cooler: 0V~10V (0~32000)

PLC program description :

1. Read CR#131 (CH1 output percentage)
2. Calculate the analog output value. Analog output value = $32000 \times CR\#131 / 1000$ (unit: 0.1%) = $32 \times D10$.
3. Sent the obtained value to D9910 for DVP04DA-E2 to control voltage/current output so as to control the heater/cooler.
4. Program:

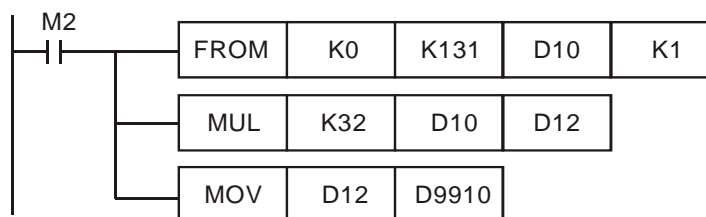

5. The relation between digital input and output voltage:

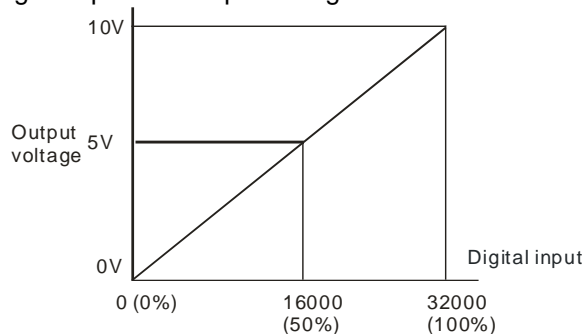

2. Cyclic Control Mode (CR: output width, output cycle)

If the heater or cooler you are using is controlled by a power switch (On/Off), other than percentage control mode you can also read two control registers (CR) from the DVP04PT-E2 module and adopt GPWM instruction as a cyclic control. Please refer to the wiring method below:

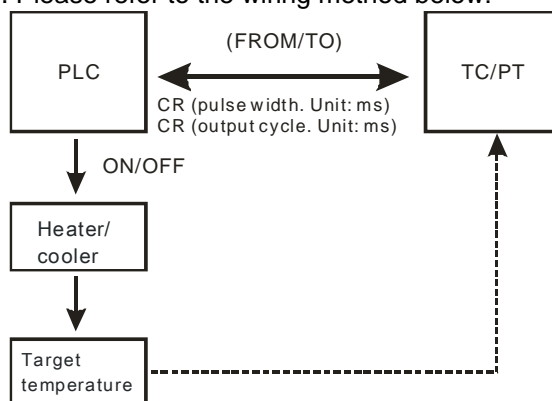

Example:

The sensor receives signals from CH1 of DVP04PT-E2. The output width of CH1 is read in CR#132, and the output cycle of CH1 is read in CR#133. Use FROM instruction to read CR#132 and CR#133 and conduct the cyclic control by the output width and cycle contained in GPWM instruction. Connect the heater/cooler with PLC Y0 to execute the output.

PLC program description:

1. Read CR#132 for output width of CH1 and CR#133 output cycle of CH1. Store the obtain value in D10 and D11.
2. Apply GPWM instruction to control the output pulse width (D10) and output cycle (D11) so as to control the connected heater/cooler.
3. Program:

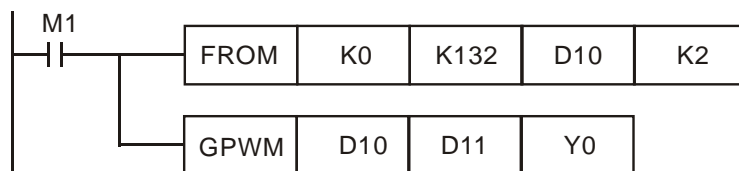

4. Assume the pulse width is 1,000 and output cycle is 2,000, the output pulse diagram will be:

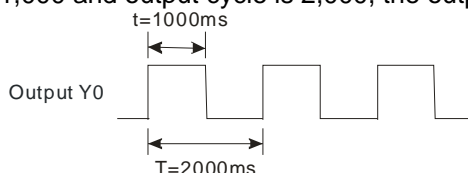

3. Analog Output Mode (CR: output volume)

If the heater or cooler you are using is controlled by voltage or current, you can read the CR which stores digital output volume of the specified channel from DVP04PT-E2 and adopt analog output function provided by DVP04DA-E2. Please refer to the wiring method below:

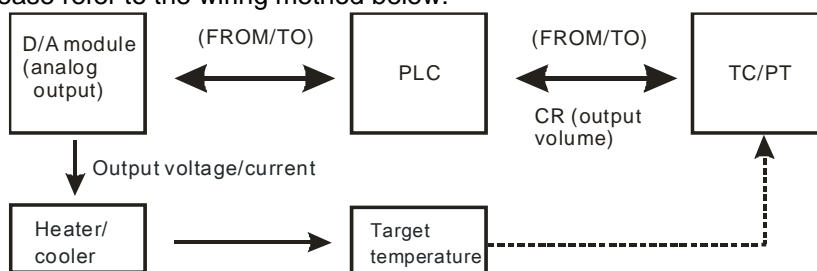

To control the heater or cooler by analog output mode, you have to set up the CR in DVP04PT-E2 which stores the range of digital output. In addition, use FROM instruction to read the CR which stores output volume and TO instruction to send the output volume to the analog output module.

Example:

Use the heater/cooler with DVP04DA-E2 to conduct analog output. The heater/cooler is connected to the current output channel of DVP04DA-E2. Output range of heater/cooler: 0 ~ 32,000 (4 ~ 20mA). We set up the upper limit (32,000) and lower limit (0) of output volume and use FROM instruction to read the digital output value from DVP04PT-E2 to D10 and sent the content in D10 to D9910 to conduct output from DVP04DA-E2.

PLC program description:

1. Before executing the program, set CR#129 (upper limit of output volume) as 32000; CR#130 (lower limit of output volume) as 0.
2. Read the content in CR#134 (output volume) to D10
3. Sent the value in D10 to D9910 to perform analog output.

4 Temperature Measurement Module DVP04PT-E2

4. Program:



5. The relation between digital input and output current:

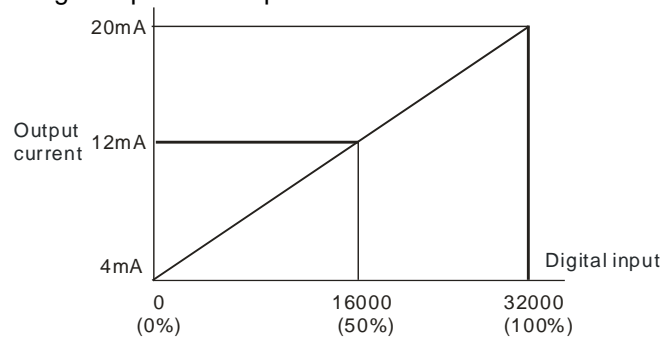

4.9.3 PID Application Example

Targets:

1. Set up target temperature.
2. Set up "auto-tuning", enable PID function and wait for the completion of "auto-tuning"
3. Once the "auto-tuning" is completed, you only need to enable manual PID for the next time.

Enable M100 to set up target temperature in D500.



Read average temperature at CH1 every 1 second.



Set up PID auto-tuning and PID RUN at M0.

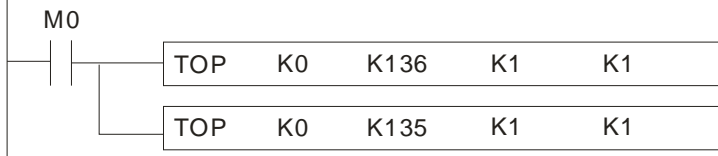

4 Temperature Measurement Module DVP04PT-E2

Set up PID in manual mode and PID RUN at M1.

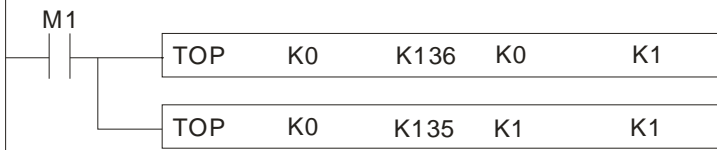

Read output width, output cycle and execute GPWM pulse width adjustment instruction.

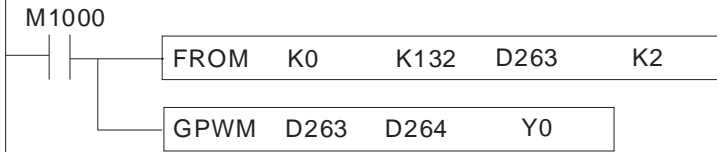

Auto-tuning: CR#136 = K0 indicates that the auto-tuning is completed. Once the auto-tuning is completed, read K_p , K_i and K_d .

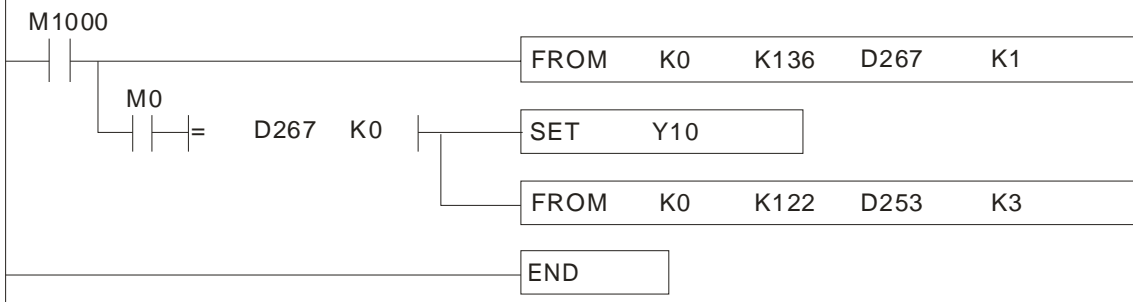

MEMO

5.1 The Thermocouple Temperature Sensor

The thermocouple is generated by Seebeck Effect. Generally, a thermocouple is composed of conductors of two different materials. When a temperature difference occurs at the two ends of the thermocouple, the thermocouple will generate a voltage signal in proportional to the temperature difference. The voltage signal ranges from tens of uV to thousands of uV; therefore, we need to magnify the voltage when using it.

The thermocouple temperature sensor indicates temperature by differential voltage, and it has already eliminated external interferences when two pairs of data are performing differential operation. Therefore, it is much more stable than a thermistor, resistive thermometer or thermal resistor and is widely applied in the industry.

The thermocouple is a loop constructed by two different metallic wires welded or twisted together (see the figure below). Different metals make two junctions in the loop. One junction is called “measuring junction” or “hot junction”, and the other is “reference junction” or “cold junction”. Placing the two junctions in different temperatures will cause a loop voltage (i.e. Seebeck Effect), and the loop voltage is in proportional to the temperature difference between the two junctions.

The loop voltage and the two junctions equate:

$$V = \int_{T_1}^{T_2} (Q_A - Q_B) dT \quad (A)$$

In which Q = the heat conduction coefficient of the metal

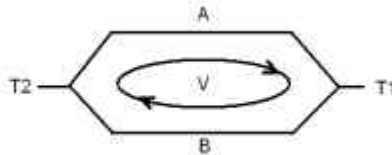

How a thermocouple works

In fact, the heat conduction coefficient of Q_A and Q_B have nothing to do with the temperature. Therefore, equation (A) can be simplified into equation (B), a more frequently used equation:

$$V = \alpha (T_2 - T_1) \quad (B)$$

There are two types of thermocouple thermometers, wrapped thermocouple and bare thermocouple. The wrapped thermocouple is wrapped with a layer of metal as protection, similar to an electrically-heated spoon. The wrapped thermocouple is used for measuring temperature of liquid and the bare thermocouple is for measuring gas temperature. Different thermocouples sense different temperature ranges and output signals, and the maximum temperature sensible varies with different materials and wires of different diameters.

5.2 Introduction

DVP04TC-E2 is able to receive 4 points of external thermocouple temperature sensors (J-type, K-type, R-type, S-type, T-type, E-type, N-type, $\pm 80\text{mV}$) and convert them into 16-bit digital signals. The data in DVP04TC-E2 can be read/written by using FROM/TO instructions or D9900 ~ D9999 in the program of DVP-PLC MPU. You can select temperatures in Celsius (resolution: 0.1°C) or Fahrenheit (resolution: 0.18°F).

5.3 Product Profile & Outline

5.3.1 DVP04TC-E2

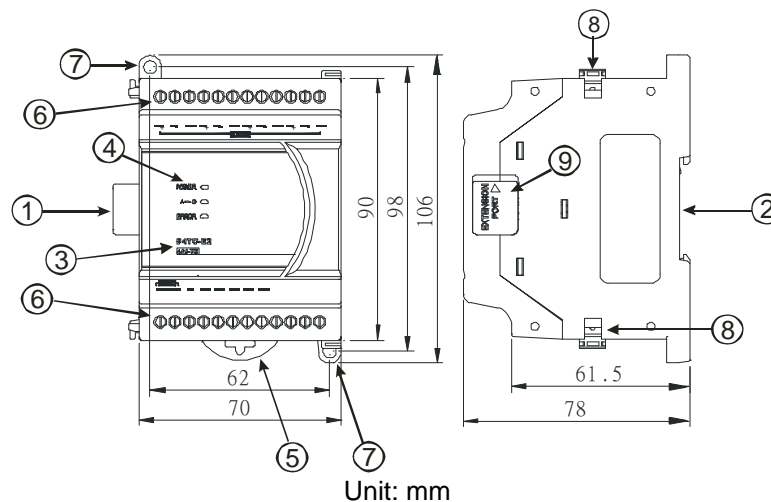

5 Temperature Measurement Module DVP04TC-E2

1. Connection port for extension unit/module	6. Terminals
2. DIN rail (35mm)	7. Mounting hole
3. Model name	8. Fixing clip for extension unit/module
4. POWER, ERROR, A→D indicators	9. Mounting port for extension unit/module
5. DIN rail clip	

I/O terminals



5.4 External Wiring

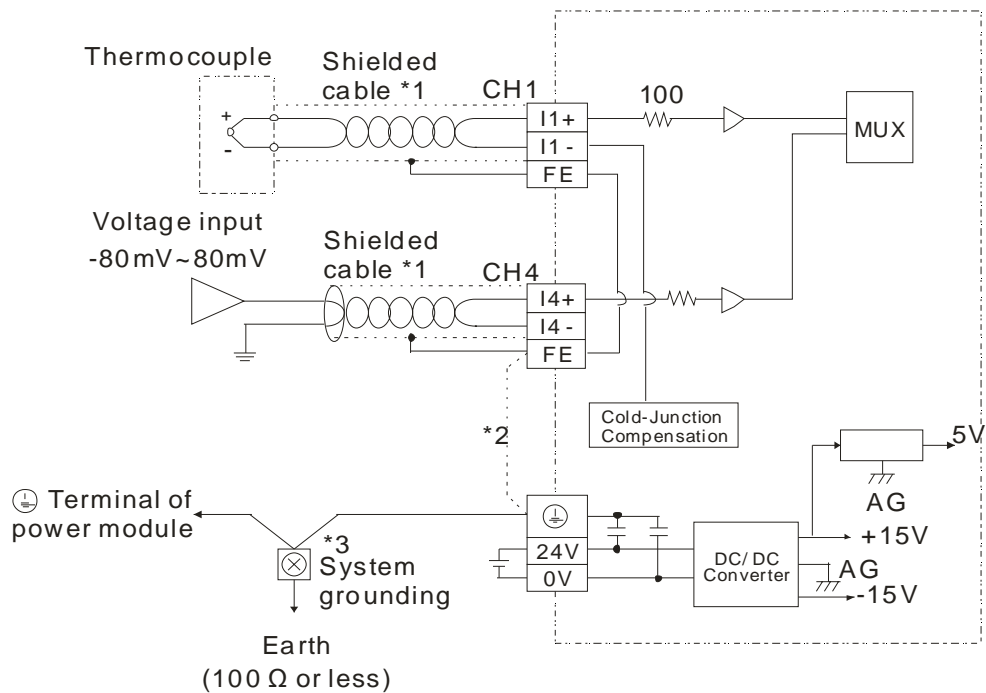

*1: Wiring for analog input should adopt the connection cable or shielding cable of thermocouple temperature sensor J-type, K-type, R-type, S-type, T-type, E-type and N-type and should be separated from other power cable or wirings that may cause interference.

*2: Connect FE with \oplus terminal for noise suppression..

*3: Connect the \oplus terminal on both power module and DVP04TC-E2 to the system grounding point then ground the point or connect it to the cover of power distribution cabinet.

5.5 Functions and Specifications

DVP04TC-E2	Celsius (°C)	Fahrenheit (°F)	Voltage input
Power supply voltage	24V DC (20.4V DC ~ 28.8V DC) (-15% ~ +20%)		
Connector	European standard fixed terminal block (Pin pitch: 5mm)		
Analog input channel	4 channels		
Applicable sensor types	J-type, K-type, R-type, S-type, T-type, E-type, N-type thermocouple; $\pm 80\text{mV}$ input impedance		
Range of input	J-type: -100°C ~ 1,150°C K-type: -100°C ~ 1,350°C R-type: 0°C ~ 1,750°C S-type: 0°C ~ 1,750°C T-type: -150°C ~ 390°C E-type: -150°C ~ 980°C N-type: -150°C ~ 1,280°C	J-type: -148°F ~ 2,102°F K-type: -148°F ~ 2,642°F R-type: 32°F ~ 3,182°F S-type: 32°F ~ 3,182°F T-type: -238°F ~ 734°F E-type: -238°F ~ 1,796°F N-type: -238°F ~ 2336°F	$\pm 80\text{mV}$

5 Temperature Measurement Module DVP04TC-E2

DVP04TC-E2	Celsius (°C)	Fahrenheit (°F)	Voltage input
Range of digital conversion	J-type: K-1000 ~ 1,1500 K-type: K-1000 ~ 1,3500 R-type: K0 ~ 1,7500 S-type: K0 ~ 1,7500 T-type: K-1500 ~ 3900 E-type: K-1500 ~ 9800 N-type: K-1500 ~ 1,2800	J-type: K-1480 ~ K2,1020 K-type: K-1480 ~ K26420 R-type: K320 ~ K3,1820 S-type: K320 ~ K3,1820 T-type: K-2380 ~K7340 E-type: K-2380 ~ K1,7960 N-type: K-2380 ~K23360	±8,000
Resolution	24 bits (0.1°C)	24 bits (0.18°F)	24 bits (0.01mV)
Overall accuracy	±0.3% when in full scale (25°C, 77°F) ±0.6% when in full scale within the range of 0 ~ 55°C (32 ~ 131°F)		
Response time	1s / all channels		
Isolation	Optical coupler isolation between digital circuits and analog circuits. Isolation between analog channels. 500VDC between digital circuits and Ground 500VDC between analog circuits and Ground 500VDC between analog circuits and digital circuits 500VDC between 24VDC and Ground 120VAC between analog channels		
Digital data format	16 significant bits are available; in 2's complement		
Average function	Supported. Available for setting up average times in CR#8 ~ CR#11. Range: K1 ~ K100.		
Self-diagnosis	Upper and lower bound detection in all channels		
Series connection to DVP-PLC MPU	The modules are numbered from 0 to 7 automatically by their distance from MPU. No.0 is the closest to MPU and No.7 is the furthest. Maximum 8 modules are allowed to connect to MPU and will not occupy any digital I/O points.		
Temperature/digital curve (Default: Mode 0)	Mode 0 (H'0000): J-type, °C (°F) Digital output 		Mode 1 (H'0001): K-type, °C (°F) Digital output
	Mode 2 (H'0002): R-type, °C (°F) Mode 3 (H'0003): S-type, °C (°F) Digital output 		Mode 4 (H'0004): T-type, °C (°F) Digital output
	Mode 5 (H'0005): E-type, °C (°F) Digital output 		Mode 6 (H'0006): N-type, °C (°F) Digital output

5 Temperature Measurement Module DVP04TC-E2

DVP04TC-E2	Celsius (°C)	Fahrenheit (°F)	Voltage input
Temperature/digital curve (Default: Mode 0)	Mode 7 (H'0007): -80mV~+80mV 		Mode -1 (H'FFFF): Channel unavailable. Average value and present value of input channels will be displayed as 32,767(H'7FFF)
Operation/storage	1. Operation: 0°C ~ 55°C (temperature), 50 ~ 95% (humidity), pollution degree 2 2. Storage: -25°C ~ 70°C (temperature), 5 ~ 95% (humidity)		
Vibration/shock immunity	International standards: IEC61131-2, IEC 68-2-6 (TEST Fc)/IEC61131-2 & IEC 68-2-27 (TEST Ea)		
Power Supply			
Max. rated power consumption	24V DC (20.4V DC ~ 28.8V DC) (-15% ~ +20%), 3W, supplied by external power		

5.6 CR (Control Register)

5.6.1 CR in DVP04TC-E2

DVP04TC-E2				Description
CR#	Save		Register content	
#0	YES	R	Model name	Set up by the system: DVP04TC-E2 model code = H'0083
#1	YES	R	Firmware version	Displaying the current firmware version in hex.
#2	YES	R/W	CH1 Input mode setting	Input mode: Default = H'0000. Take CH1 for example: Mode 0 (H'0000): J-type (-100°C ~ 1,150°C). Mode 1 (H'0001): K-type (-100°C ~ 1,350°C). Mode 2 (H'0002): R-type (0°C ~ 1,750°C). Mode 3 (H'0003): S-type (0°C ~ 1,750°C). Mode 4 (H'0004): T-type (-150°C ~ 390°C). Mode 5 (H'0005): E-type (-150°C ~ 980°C). Mode 6 (H'0006): N-type (-150°C ~ 1,280°C). Mode 7 (H'0007): -80mV~+80mV Mode -1(H'FFFF): Close.
#3	YES	R/W	CH2 Input mode setting	
#4	YES	R/W	CH3 Input mode setting	
#5	YES	R/W	CH4 Input mode setting	
#6			Reserved	
#7	YES	R/W	Temperature unit setting	Select the temperature unit (Celsius °C / Fahrenheit °F). Default = H0(°C)
#8	YES	R/W	CH1 average times	Set average times at CH1 ~ CH4 Range = K1 ~ K100 Default = K10
#9	YES	R/W	CH2 average times	
#10	YES	R/W	CH3 average times	
#11	YES	R/W	CH4 average times	
#12	NO	R	Average temperature measured at CH1	Average of temperature measured at CH1 ~ CH4. Temperature unit: set in CR#7
#13	NO	R	Average temperature measured at CH2	
#14	NO	R	Average temperature measured at CH3	
#15	NO	R	Average temperature measured at CH4	
#16 ~ #19			Reserved	
#20	NO	R	Present temperature measured at CH1	Present of temperature measured at CH1 ~ CH4. Temperature unit: set in CR#7
#21	NO	R	Present temperature measured at CH2	
#22	NO	R	Present temperature measured at CH3	
#23	NO	R	Present temperature measured at CH4	
#24 ~ #27			Reserved	

5 Temperature Measurement Module DVP04TC-E2

DVP04TC-E2				Description
CR#	Save	Register content		
#28	YES	R/W	Adjusted Offset value of CH1	Set the adjusted Offset value of Ch1 ~ Ch4. Default = K0 Range: K-400~K400. Temperature unit: set in CR#7 Definition of Offset at Ch1 ~ Ch4 in DVP04TC-E2: Deviation digital value from the target temperature/voltage
#29	YES	R/W	Adjusted Offset value of CH2	
#30	YES	R/W	Adjusted Offset value of CH3	
#31	YES	R/W	Adjusted Offset value of CH4	
#32 ~ #39				Reserved
#40	YES	R/W	Function: Set value changing prohibited	Prohibit set value changing in CH1 ~ CH4
#41	NO	R/W	Function: Save all the set values	Save all the set values, Default =H'0000
#42	NO	R/W	Function: Return to default setting	Set all values to default setting, Default = H'0000
#43	NO	R	Error status	Register for storing all error status. See the table of error status for more information.
#44 ~ #99				Reserved
#100	YES	R/W	Function: Enable/Disable limit detection	Enable/Disable the upper and lower bound detection function
#101	NO	R/W	Upper and lower bound status	Display the upper and lower bound value, Default =H'0000
#102	YES	R/W	Set value of CH1 upper bound	Set value of CH1~CH4 upper bound. Default = K32,000
#103	YES	R/W	Set value of CH2 upper bound	
#104	YES	R/W	Set value of CH3 upper bound	
#105	YES	R/W	Set value of CH4 upper bound	
#106 ~ #107				Reserved
#108	YES	R/W	Set value of CH1 lower bound	Set value of CH1~CH4 lower bound. Default = K-32,000
#109	YES	R/W	Set value of CH2 lower bound	
#110	YES	R/W	Set value of CH3 lower bound	
#111	YES	R/W	Set value of CH4 lower bound	
#112 ~ #119				Reserved

DVP04TC-E2						Description	
CR#				Save	Register content		
CH1	CH2	CH3	CH4				
#120	#140	#160	#180	YES	R/W	SV (Setpoint)	Please set the temperature value according to proper range of each sensor type. Default = K0
#121	#141	#161	#181	YES	R/W	Sampling time (s)	Range: K1 ~ K30 (s). Default = K2
#122	#142	#162	#182	YES	R/W	K _P	Proportional control constant. Default = K121
#123	#143	#163	#183	YES	R/W	K _I	Integral constant. Default = K2,098
#124	#144	#164	#184	YES	R/W	K _D	Derivative constant. Default = K-29.
#125	#145	#165	#185	YES	R/W	Upper limit of I value	Upper limit of I value. Default = K0
#126	#146	#166	#186	YES	R/W	Lower limit of I value	Lower limit of I value. Default = K0.
#127	#147	#167	#187	NO	R	I value	Current accumulated offset value.
#128	#148	#168	#188	YES	R/W	Heating/cooling	0: Heater, 1: Cooler. Default = K0
#129	#149	#169	#189	YES	R/W	Upper limit of output	Upper limit of output. Default = K32,000
#130	#150	#170	#190	YES	R/W	Lower limit of output	Lower limit of output. Default = K0
#131	#151	#171	#191	NO	R	Output percentage (%)	Output percentage (Unit: 0.1%).
#132	#152	#172	#192	NO	R	Output width (ms)	Width of control output. Unit: ms.
#133	#153	#173	#193	NO	R	Output cycle (ms)	Cycle of control output. Unit: ms.
#134	#154	#174	#194	NO	R	Output volume	Output volume
#135	#155	#175	#195	NO	R/W	PID_RUN/STOP	0: STOP, 1: RUN. Default = K0
#136	#156	#176	#196	NO	R/W	Auto-tuning	0: Disabled, 1: Auto-tuning. Default = K0

Symbols:
 YES: When CR#41 is set to H'5678, the set value of CR will be saved. NO: Set value will not be saved
 R: Able to read data by FROM instruction, W: Able to write data by using TO instructions

5.6.2 Explanation on CR

CR#0: Model name

[Explanation]

1. DVP04TC-E2 model code = H'0083.
2. You can read the model name in the program to see if the extension module exists.

CR#1: Firmware version

[Explanation]

Display the current firmware version in hex, e.g. version V1.00 is indicated as H'0100.

CR#2, 3, 4, 5: CH1 ~ CH4 input mode setting

[Explanation]

Set the working mode of the channels in the analog input module. There are 9 modes for each channel which can be set up separately.

When you set CH1 as mode 1 (H'0001) CR#2 has to be set as H'0001. The default setting = H'0000. Take CH1 as example:

Mode 0 (H'0000): J-type (-100°C ~1,150°C).

Mode 1 (H'0001): K-type (-100°C ~ 1,350°C).

Mode 2 (H'0002): R-type (0°C ~ 1,750°C).

Mode 3 (H'0003): S-type (0°C ~ 1,750°C).

Mode 4 (H'0004): T-type (-150°C ~ 390°C).

Mode 5 (H'0005): E-type (-150°C ~ 980°C).

Mode 6 (H'0006): N-type (-150°C ~ 1,280°C).

Mode 7 (H'0007): -80mV~+80mV

Mode-1 (H'FFFF): Channel 1 unavailable

CR#7: Temperature unit setting

[Explanation]

Select the temperature unit of average temperature and present temperature. (Celsius °C / Fahrenheit °F). Default = H'0000.

Mode 0 (H'0000): Celsius °C.

Mode 1 (H'0001): Fahrenheit °F.

CR#8, 9, 10, 11: CH1 ~ CH4 average times

[Explanation]

1. The average times of the signals at CH1 ~ CH4.
2. Setup range for DVP04TC-E2: K1 ~ K100. Default = K10. If the set value exceeds K100, the value will be set as K100; if the set value is lower than K1, the set value will be set as K1

CR#12, 13, 14, 15: Average temperature measured at CH1 ~ CH4

[Explanation]

The average temperature measured at CH1 ~ CH4 is calculated according to the average times set in CR#8 ~ CR#11. Temperature unit: set in CR#7. For example, if the average times is set as K10, the contents in CR#12 ~ CR#15 will be the average of the most recent 10 temperature signals in CH1 ~ CH4

CR#20, 21, 22, 23: Present temperature measured at CH1 ~ CH4

[Explanation]

Display the present temperature at CH1 ~ CH4. Temperature unit: set in CR#7.

CR#28, 29, 30, 31: Adjusted Offset value of CH1 ~ CH4

[Explanation]

1. Set the adjusted Offset value of CH1 ~ CH4.
2. Range: K-400~K400
3. Default setting = K0.

Definition of Offset in DVP04TC-E2:

Deviation digital value from the target temperature/voltage

- Mode 0 ~ Mode 6: $1_{SCALE} = 0.1^{\circ}$.

Equation:

$$Y = \left(\frac{X(^{\circ})}{0.1(^{\circ})} - Offset \right)$$

Y=Digital output, X= Measured input

- Mode 7: $1_{SCALE} = 80\text{mV}/8000=0.01 \text{ mV}$.

Equation:

$$Y = \left(\frac{X(\text{mV})}{0.01(\text{mV})} - Offset \right)$$

Y=Digital output, X= voltage input

CR#40: Function: Set value changing prohibited, Default = H'0000

[Explanation]

Description	
bit0	b0=0, CH1 changing allowed; b0=1, CH1 changing prohibited
bit1	b1=0, CH2 changing allowed; b1=1, CH2 changing prohibited
bit2	b2=0, CH3 changing allowed; b2=1, CH3 changing prohibited
bit3	b3=0, CH4 changing allowed; b3=1, CH4 changing prohibited
bit4 ~ bit15	Reserved
Relative Parameters	
CR#2 ~ CR#5	Input mode setting at CH1 ~ CH4
CR#8 ~ CR#11	Average times at CH1 ~ CH4
CR#28 ~ CR#31	Offset settings at CH1 ~ CH4
CR#42	Returning to default setting
CR#100	Function: Enable/Disable limit detection
CR#102~CR#105	Set value of CH1~CH4 upper bound
CR#108~CR#111	Set value of CH1~CH4 lower bound
CR#120~CR#196	PID relative settings

CR#41: Function: Save all the set values. Default=H'0000

[Explanation]

Save function setting. Save all the set values to the internal flash memory. When saving is completed, CR#41 will be set to H'FFFF.

Set value	Function
H0	No action
FFFF	Saving completed
H5678	Saving enabled.

Note: Default setting = H0. When set value = H'5678, saving will be enabled, and CR#41 will be set to H'FFFF when saving is completed. If the set value is not H'5678, the set value will remain H'0. For example, input K1 into CR#41, and the value will remain H'0.

CR#42: Function: Return to default setting, Default = H'0000

[Explanation]

Description	
bit0	b0=0, no action on CH1; b0=1, set CH1 to default setting
bit1	b1=0, no action on CH2; b1=1, set CH2 to default setting
bit2	b2=0, no action on CH3; b2=1, set CH3 to default setting
bit3	b3=0, no action on CH4; b3=1, set CH4 to default setting
bit4 ~ bit15	Reserved

Note: Set designated bit as 1 and the corresponding channel will be returned to default setting. When setting is completed, the value will be set to 0. If CR#40(Set value changing prohibited) is enabled, the default setting in CR#42 will be invalid, and all set values will remain unchanged. Error Code bit 12 of CR#43 will be set to 1.

Relative Parameters	
CR#2 ~ CR#5	Input mode setting at CH1 ~ CH4
CR#8 ~ CR#11	Average times at CH1 ~ CH4
CR#28 ~ CR#31	Offset settings at CH1 ~ CH4
CR#100	Function: Enable/Disable limit detection
CR#102~CR#105	Set value of CH1~CH4 upper bound
CR#108~CR#111	Set value of CH1~CH4 lower bound
CR#120~CR#196	PID relative settings

CR#43: Error status. Default=H'0000

[Explanation]

CR#43: error status value. See the table below:

Description		
bit0	K1 (H'1)	Power Supply error

5 Temperature Measurement Module DVP04TC-E2

Description		
bit1	K2 (H'2)	Hardware error
bit2	K4 (H'4)	Upper / lower limit error
bit3	K8 (H'8)	CH1 Conversion error
bit4	K16 (H'10)	CH2 Conversion error
bit5	K32 (H'20)	CH3 Conversion error
bit6	K64 (H'40)	CH4 Conversion error
bit7 ~ bit8		Reserved
bit9	K512(H'0200)	Mode setting error
bit10	K1024(H'0400)	Average times error
bit11	K2048(H'0800)	Upper / lower limit setting error
bit12	K4096(H'1000)	Set value changing prohibited
bit13	K8192(H'2000)	Communication breakdown on next module
bit14 ~ bit15		Reserved

 **Note:** Each error status is determined by the corresponding bit (b0 ~ b13) and there may be more than 2 errors occurring at the same time. 0 = normal; 1 = error

CR#100: Function: Enable/Disable limit detection. Default =H'0000

[Explanation]

Description	
bit0=1	Enable CH1 limit detection
bit1=1	Enable CH2 limit detection
bit2=1	Enable CH3 limit detection
bit3=1	Enable CH4 limit detection
bit4 ~ bit15	Reserved

CR#101: Upper and lower bound status. Default =H'0000

[Explanation]

Description	
bit0=1	CH1 exceeds lower bound
bit1=1	CH2 exceeds lower bound
bit2=1	CH3 exceeds lower bound
bit3=1	CH4 exceeds lower bound
bit4 ~ bit7	Reserved
bit8=1	CH1 exceeds upper bound
bit9=1	CH2 exceeds upper bound
bit10=1	CH3 exceeds upper bound
bit11=1	CH4 exceeds upper bound
bit12 ~ bit15	Reserved

CR#102, 103, 104, 105: Set value of CH1 ~ CH4 upper bound. Default =H'0000

[Explanation]

Set the upper bound value of CH1 ~ CH4

CR#108, 109, 110, 111: Set value of CH1 ~ CH4 lower bound. Default =H'0000

[Explanation]

Set the lower bound value of CH1 ~ CH4..

CR#120, 140, 160, 180: SV (Setpoint)

[Explanation]

1. Please set the temperature value (unit: 0.1 degree) according to proper range of each sensor type, i.e. suppose the target temperature is 100°C, write K1000 into the specified CR by using TO instruction.
2. Default =K0.

CR#121, 141, 161, 181: Sampling time (s)

[Explanation]

1. Set up the time interval between each action of sampling. If the temperature in the control environment does not vary significantly, set up longer sampling time; however if temperature varies quickly, set up shorter sampling time.
2. Setup range: 1 ~ 30, Default =K2. The conversion time of each channel in the temperature measurement module is approximately 1 second. Therefore, if the value is smaller than 1, 1 will be automatically written into the CR. If the value is bigger than 30, 30 will be written into the CR.
3. Output cycle time (ms) is equal to the setup sampling time (s), i.e. if the sampling time is set as 2, the output cycle will be 2,000 correspondingly.

CR#122, 142, 162, 182: K_P value, Default =K121

[Explanation]

K_P: The proportional control constant, i.e. proportional band. The proportional control refers to that the output is in proportional to the error. Please refer to the PID operation formula and set up an appropriate parameter.

$$\text{Output MV (\%)} = E / K_P \times 100\%$$

MV : Output value

K_P : Proportional gain

E(t) : Error value

Example:

Set up K_P = 10, E = 1, K_I = 0, K_D = 0 (Close K_I, K_D)

$$\text{MV (\%)} = 1 / 10 \times 100\% = 10\%$$

The output percentage displayed in CR#131, 151, 171, 191 will be 10%.

CR#123, 143, 163, 183: K_I value, Default = K2098

[Explanation]

K_I: Integral constant.

1. Suppose only proportional control is applied, there will be certain deviation between the set value and the actual temperature. If integral control is applied, the deviation will decrease gradually and the target temperature can be achieved.
2. Integral control function will be disabled if K_I is set to the CRs.
3. If the curve is too gradual, please adjust K_I. The closer the K_I to 0, the more abrupt the curve becomes.

CR#124, 144, 164, 184: K_D value, Default = K-29

[Explanation]

K_D: Derivative constant.

1. Derivative control enhances disturbance rejection and helps the control status get back to the target temperature quickly.
2. Derivative control function will be disabled if K_D is set to the CRs.
3. If the output percentage fluctuates too much, please adjust K_D. The closer K_D value to 0, the less fluctuating the output percentage will be.

CR#125, 145, 165, 185: Upper limit of I value, Default = K0**CR#126, 146, 166, 186: Lower limit of I value, Default = K0**

[Explanation]

1. When both upper limit and lower limit are 0, the upper/lower limit function for I value will be closed, which means there will be no upper/lower limit for I value.
2. When the upper limit is set to be smaller than the lower limit, the upper and lower limit will be set to the same value.

CR#127, 147, 167, 187: I value

[Explanation]

Current accumulated offset value.

CR#128, 148, 168, 188: Heating/cooling

[Explanation]

Select heating or cooling control. Set the CR to “0” if your control target is a heater. Set the CR to “1” if your control target is a cooler. The default setting = H'0000.

Mode 0 (H'0000): Heater.

Mode 1 (H'0001): Cooler.

CR#129, 149, 169, 189: Upper limit of output. Default = K32,000

CR#130, 150, 170, 190: Lower limit of output. Default = K0

[Explanation]

1. The output volume is calculated from the upper limit and lower limit.
2. For example, if the upper/lower limit is set to 0 ~ 32,000, when the output comes to 50%, the output volume will be 16,000. Please set up this CR according to the analog output you are using.

CR#131, 151, 171, 191: Output percentage (0.1%)

[Explanation]

The result obtained from the PID operation. Unit: 0.1%. For example, if the PID operating result is 100, the output percentage will be 10%.

CR#132, 152, 172, 192: Output width (ms)

CR#133, 153, 173, 193: Output cycle (ms)

[Explanation]

If you are using the cyclic control mode to control your target, please read the two CRs. For example, if the cycle is 2,000 and width 1,000, the output pulse will shape like below:

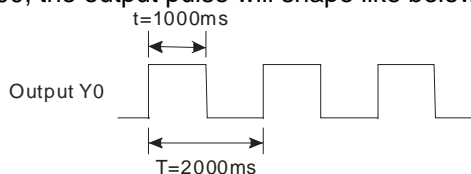

CR#134, 154, 174, 194: Output volume

[Explanation]

Formula of output volume:

$$\text{Output Volume} = (\text{Output Upper Limit} - \text{Output Lower Limit}) \times \text{Output \%} + \text{Output Lower Limit}$$

Example:

Control by current 4 ~ 20mA (0 ~ 32,000)

Output upper limit: 32,000

Output lower limit: 0

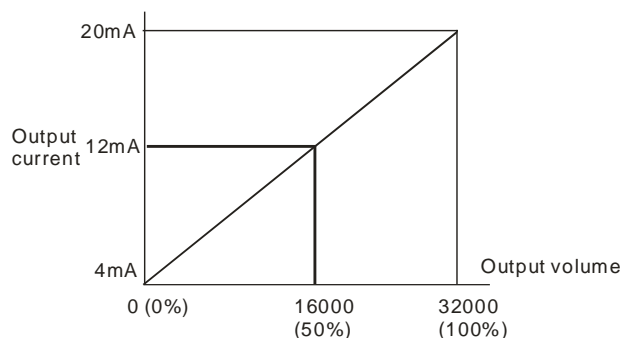

CR#135, 155, 175, 195: PID_RUN/STOP

[Explanation]

1. If you want to apply auto-tuning function, enable auto-tuning function before setting PID function as RUN. When auto-tuning is completed, CR#136, 156, 176, 196 will be cleared as 0, and the obtained value of K_P / K_I / K_D will be stored into corresponding CRs.
2. PID_RUN/STOP, K0: STOP, K1: RUN. Default = K0.

CR#136, 156, 176, 196: Auto-tuning

[Explanation]

1. If you want to apply auto-tuning function, set the auto-tuning CR to K1 to enable auto-tuning function before setting PID function as RUN. When auto-tuning is completed, CR#136, 156, 176, 196 will be cleared as 0, and the obtained value of $K_P / K_I / K_D$ will be stored into corresponding CRs.
2. Auto-tuning, K0: Disabled, K1: Auto-tuning. Default = K0.

Note:

1. Set K_P , K_I , and K_D to "0" to disable the PID function. If you want to use proportional control only, set K_I and K_D to "0".
2. If you do not know how to tune PID parameters in your control environment, use "auto-tuning" to generate K_P , K_I and K_D and further modify them into better K_P , K_I and K_D . To utilize the auto-tuning, set the auto-tuning CR to K1. After the auto-tuning is completed, the CR will automatically return to K0.
3. If you want to fill in your own K_P , K_I and K_D , please set up K_P first according to your experiences and set K_I and K_D to "0" to disable the integral and derivative control functions. When K_P is set, modify K_I and K_D . We recommend you to adjust K_I decreasingly and K_D downwards from 0.
4. If the output percentage fluctuates too much, please adjust K_D . The closer K_D value to 0, the less fluctuating the output percentage will be. Besides, if the curve is too gradual, please adjust K_I . The closer the K_I to 0, the more abrupt the curve becomes.

5.6.3 Explanation on Special Registers D9900~D9999

When ES2 MPU is connected with modules, registers D9900~D9999 will be reserved for storing values from modules. You can apply MOV instruction to operate values in D9900~D9999.

When ES2 MPU is connected with DVP04TC-E2, the configuration of special registers is as below:

Module#0	Module#1	Module#2	Module#3	Module#4	Module#5	Module#6	Module#7	Description
D1320	D1321	D1322	D1323	D1324	D1325	D1326	D1327	Model code
D9900	D9910	D9920	D9930	D9940	D9950	D9960	D9970	CH1 average temperature
D9901	D9911	D9921	D9931	D9941	D9951	D9961	D9971	CH2 average temperature
D9902	D9912	D9922	D9932	D9942	D9952	D9962	D9972	CH3 average temperature
D9903	D9913	D9923	D9933	D9943	D9953	D9963	D9973	CH4 average temperature

1. D9900~D9999 are average input values of CH1 ~ CH4 and the average times is K1~K100. When the average times is set to K1, the values displayed in D9900~D9999 are current values. You can use: 1. ES_AIO Configuration Function of WPLSoft (refer to **5.8 Applications** in this manual) or 2. FROM/TO instructions (CR#8~CR#11) to set the average times as K1

2. Example:

Ladder diagram:

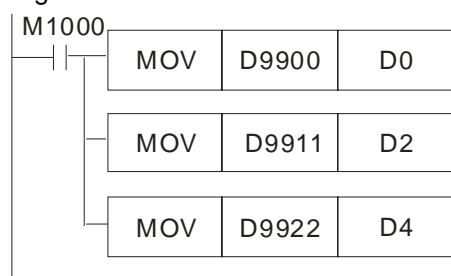

Explanation:

Save CH1 average temperature of Module#0 to D0

Save CH2 average temperature of Module#1 to D2

Save CH3 average temperature of Module#2 to D4

5.7 Temperature Conversion in DVP04TC-E2

The user can adjust the conversion curves according to the actual needs by changing the Offset value (CR#28 ~ CR#31).

Definition of Offset in DVP04TC-E2:

Deviation digital value from the target temperature/voltage

- For temperature measured Mode 0~6: $1_{SCALE} = 0.1^\circ$.

Equation:

$$Y = \left(\frac{X(^{\circ})}{0.1(^{\circ})} - Offset \right)$$

Y=Digital output, X= Measured input

5 Temperature Measurement Module DVP04TC-E2

- For voltage input Mode 7: $1_{SCALE} = 80\text{mV}/8000=0.01 \text{ mV}$.
Equation:

$$Y = \left(\frac{X(\text{mV})}{0.01(\text{mV})} - \text{Offset} \right)$$

Y=Digital output, X= voltage input

5.7.1 Conversion Curve

- Mode 0 (H'0000): J-type, °C (°F)

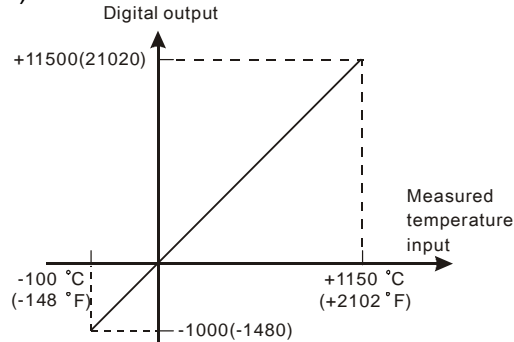

Mode 0 of CR#2~ CR#5	-100°C ~ 1150°C (-1000~11500) -148°F ~ 2102°F (-1480~21020)
Offset (CR#34 ~ CR#37)	Offset value

- Mode 1 (H'0001): K-type, °C (°F)

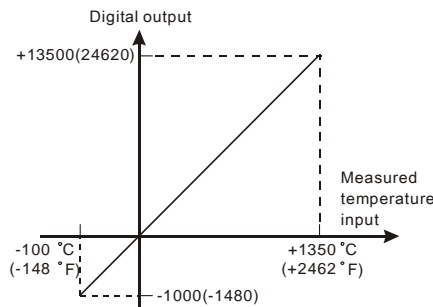

Mode 1 of CR#2~ CR#5	-100°C ~ 1350°C (-1000~13500) -148°F ~ 2462°F (-1480~24620)
Offset (CR#34 ~ CR#37)	Offset value

- Mode 2 (H'0002): R-type, °C (°F), Mode 3 (H'0003): S-type, °C (°F)

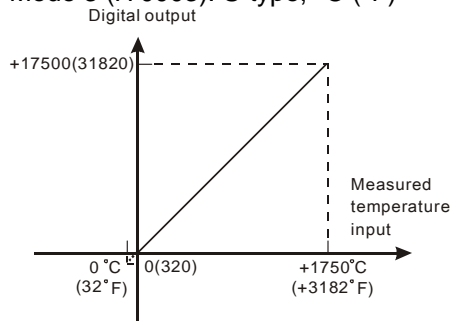

Mode 2, 3 of CR#2~ CR#5	0°C ~ 1750°C (0~17500) 32°F ~ 3182°F (320~31820)
Offset (CR#34 ~ CR#37)	Offset value

5 Temperature Measurement Module DVP04TC-E2

- Mode 4 (H'0004): T-type, °C (°F)

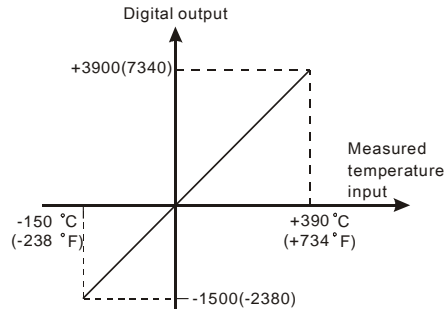

Mode 4 of CR#2~ CR#5	-150°C ~ 390°C (-1500~3900) -238°F ~ 734°F (-2380~7340)
Offset (CR#34 ~ CR#37)	Offset value

- Mode 5 (H'0005): E-type, °C (°F)

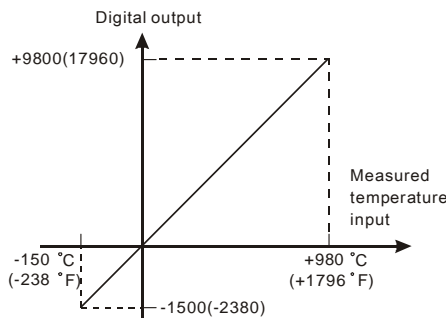

Mode 5 of CR#2~ CR#5	-150°C ~ 980°C (-1500~9800) -238°F ~ 1796°F (-2380~17960)
Offset (CR#34 ~ CR#37)	Offset value

- Mode 6 (H'0006): N-type, °C (°F)

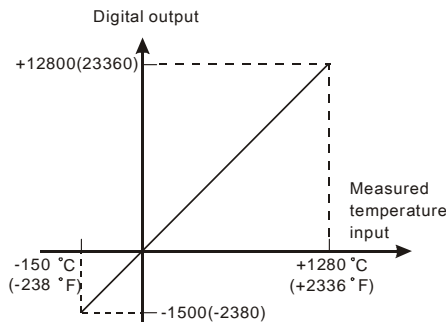

Mode 6 of CR#2~ CR#5	-150°C ~ 1280°C (-1500~12800) -238°F ~ 2336°F (-2380~23360)
Offset (CR#34 ~ CR#37)	Offset value

5 Temperature Measurement Module DVP04TC-E2

- Mode 7 (H'0007): -80mV~+80mV

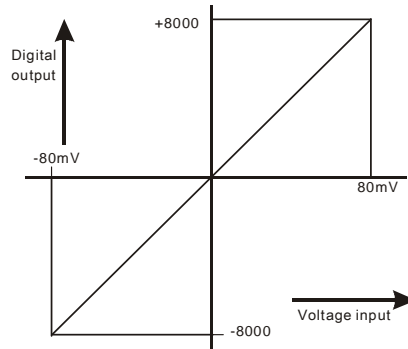

Mode 7 of CR#2~ CR#5	-80mV~+80mV (-8000~8000)
Offset (CR#34 ~ CR#37)	Offset value

5.7.2 Adjusting Conversion Curve

1. Description

- If there is certain deviation in the measurement results, you can make adjustments on the Offset value to modify the conversion curve according to your actual needs. For example, if the deviation temperature from the target temperature (measured temperature) is 2°C, set the Offset of CH1 as 20 (2°C / 0.1°C = 20).

$$Y = \left(\frac{X(^{\circ}\text{C})}{0.1(^{\circ}\text{C})} - \text{Offset} \right)$$

Y=Digital output, X= Measured input

Example: If X= 2°C, Y=?

$$Y = \left(\frac{2(^{\circ}\text{C})}{0.1(^{\circ}\text{C})} - 20 \right) = 0$$

- You only need to set up the PT conversion curve for once. Set up CR#40 (Set value changing prohibited) to prevent incorrect operations.

2. Adjusted Curve

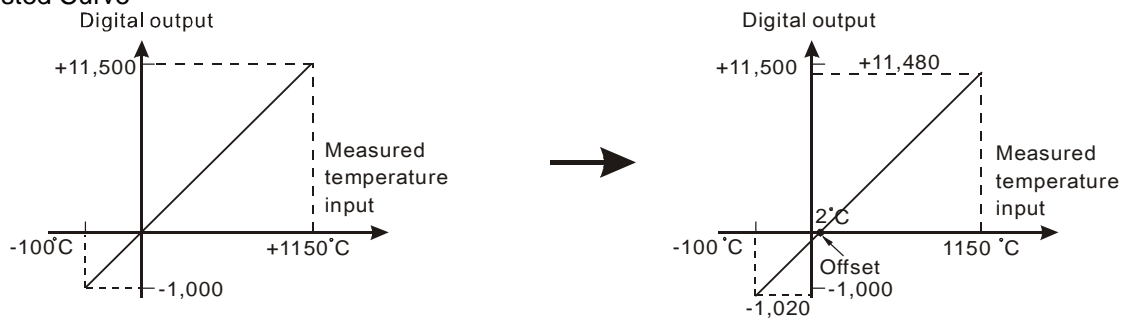

3. Devices

- X0 = On: Set the input mode of the signals at CH1 as mode 0.
- X1 = On: Set Offset value of CH1 as 20 (2°C).
- M0 = On: Disable CH1 set value changing.

4. Program explanation

- When X0 = On, set CR#2 as K0 (H'0000) and the signal input mode at CH1 as mode 0 (J-Type).
- When X1 = On, write K20 (Offset value of CH1) into CR#28.
- When X1 goes from On to Off, set M0 = On to disable the adjustment on TC conversion curve. Write K1 (H'1) into CR#40, b0=1 to disable CH1 set value changing.

5. Program example

Ladder diagram:

Explanation:

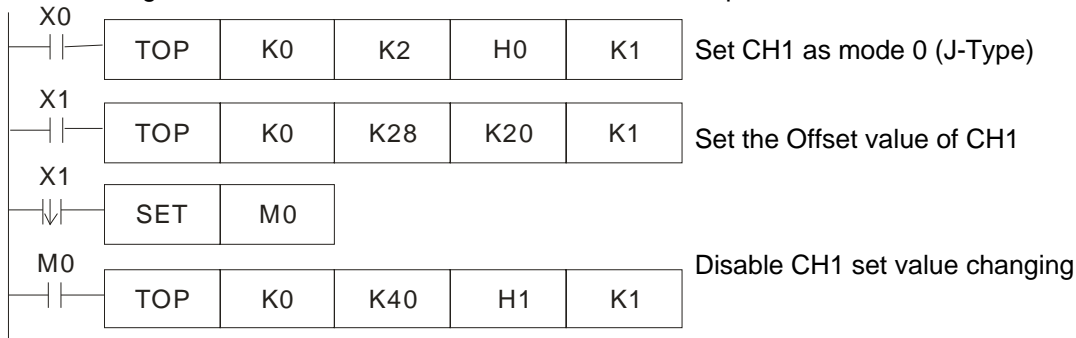

5.8 Applications

5.8.1 Thermocouple Temperature Measurement System

1. Description

- Measuring temperature by thermocouple temperature sensor.

2. Devices

- M0: set the average times.
- M1: switch the temperature unit of average and present temperature
- D20 ~ D23: average Celsius temperature at CH1 ~ CH4
- D30 ~ D33: average Fahrenheit temperature at CH1 ~ CH4
- D40 ~ D43: present Celsius temperature at CH1 ~ CH4
- D50 ~ D53: present Fahrenheit temperature at CH1 ~ CH4

3. Program explanation

- M0=Off, set the average times of input signals at CH1 ~ CH4 as 10, M0=On set the average times of input signals at CH1 as 1.
- M1=Off, temperature unit = °C; M1=On temperature unit = °F.
- M0=Off, M1=Off, Store the average Celsius temperature at CH1 ~ CH4 into D20 ~ D23.
- M0=Off, M1=On, Store the average Fahrenheit temperature at CH1 ~ CH4 into D30 ~ D33.
- M0=On, M1=Off, Store the present Celsius temperature at CH1 ~ CH4 into D40 ~ D43.
- M0=On, M1=On, Store the present Fahrenheit temperature at CH1 ~ CH4 into D50 ~ D53.
- DVP04TC-E2 stores the obtained temperature value to special registers. Therefore, you only need to read the content in the special registers to obtain the measured temperature. Unit of the temperature: 0.1°C or 0.1°F.

4. Program example

Ladder diagram:

Explanation:

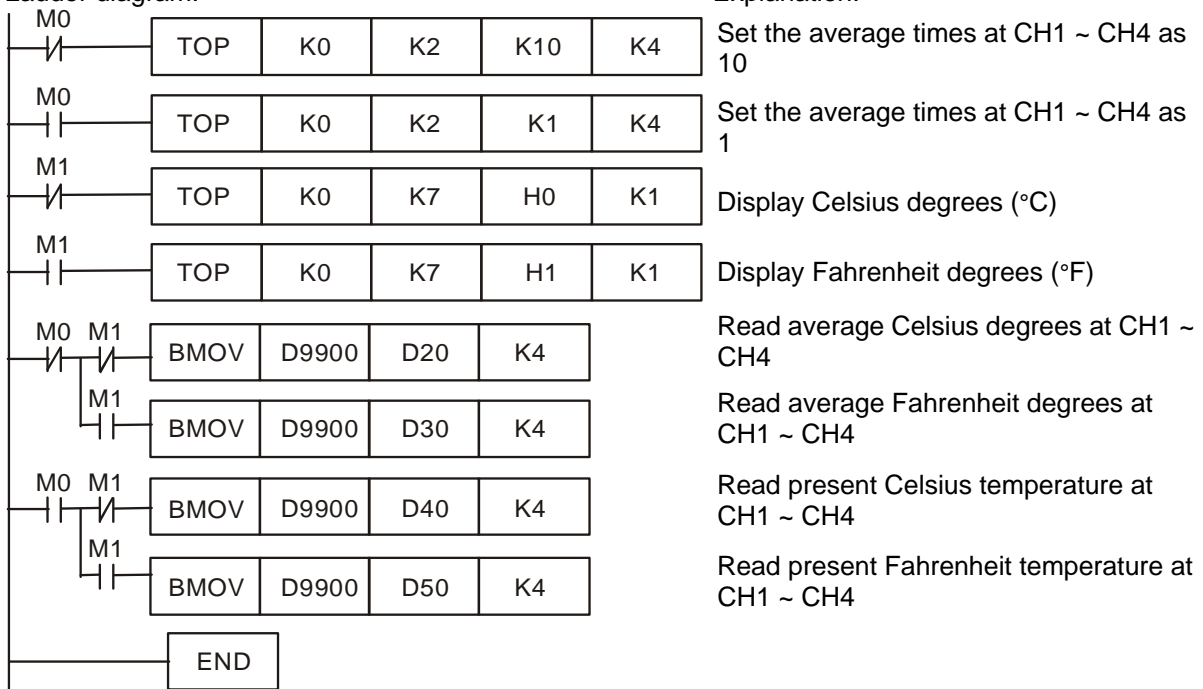

5 Temperature Measurement Module DVP04TC-E2

5.8.2 How to Set the Module Wizard in WPLSoft

1. Open WPLSoft and click on  .



2. You will see the “Auxiliary Design of Extension Module” window. Click on NO. “0” and select “DVP04TC-E2 Temperature Measurement Module”.

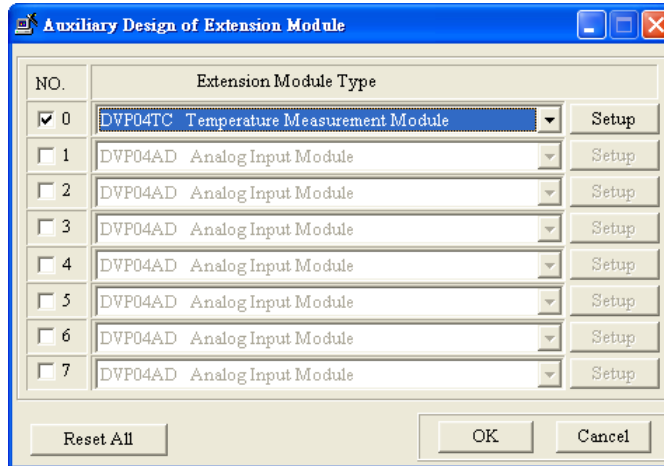

3. You will then see this window.

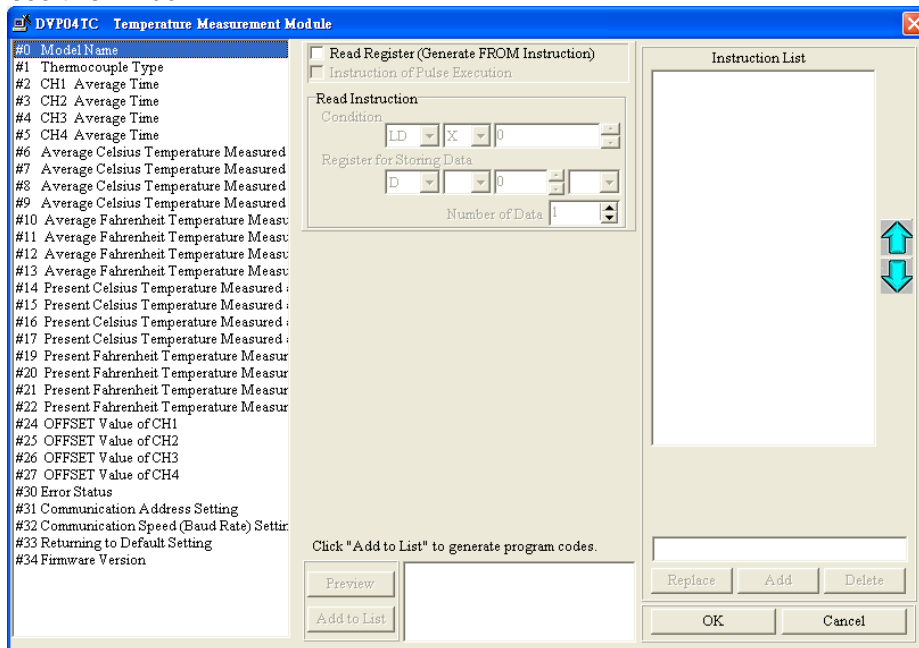

4. Next, let's take [5.8.1 Thermocouple temperature measurement system](#) as example.
 - Step 1: Select "#1 Thermocouple Type".
 - Step 2: Check "Write Register" to generate TO instruction. Set the condition as "LD M1002",
 - Step 3: Set CH1 ~ CH4 as "J Type"
 - Step 4: Click "Preview" to check if the generated program codes are correct.
 - Step 5: Click "Add to List" to display the instruction codes in "Instruction List". The setup of CR#1 is completed.

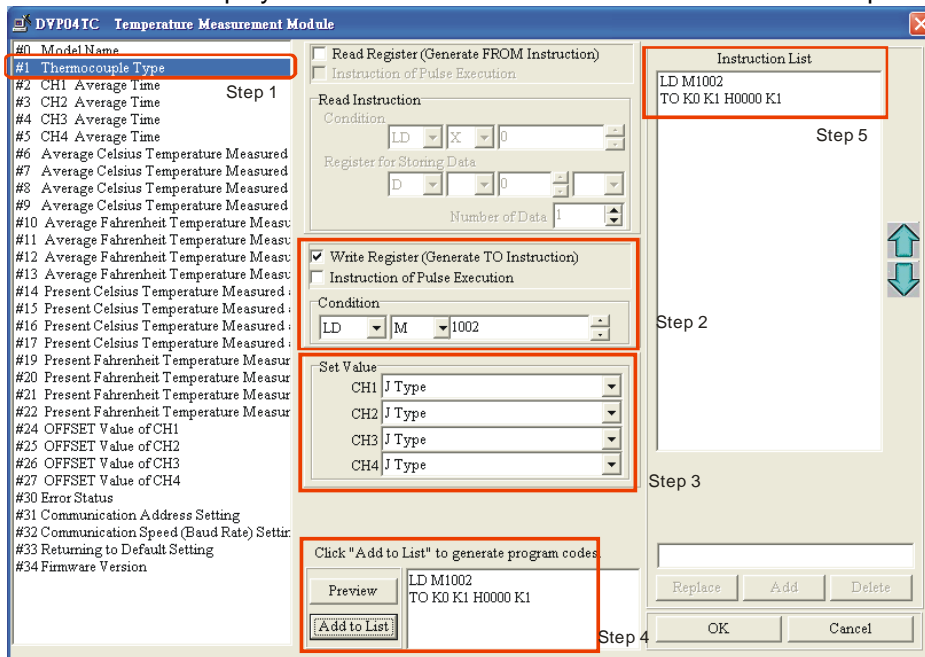

5. Setting up CR#2 is similar to the setup of CR#1.
 - Step 1: Select "#2 CH1 Average Time"
 - Step 2: Check "Write Register" to generate TO instruction. Set the condition as "LD M1000".
 - Step 3: Set the set value as "K10" and number of data as "1".
 - Step 4: Click "Preview" to check if the generated program codes are correct.
 - Step 5: Click "Add to List" to display the instruction codes in "Instruction List". The setup of CR#2 ~ CR#5 is completed.

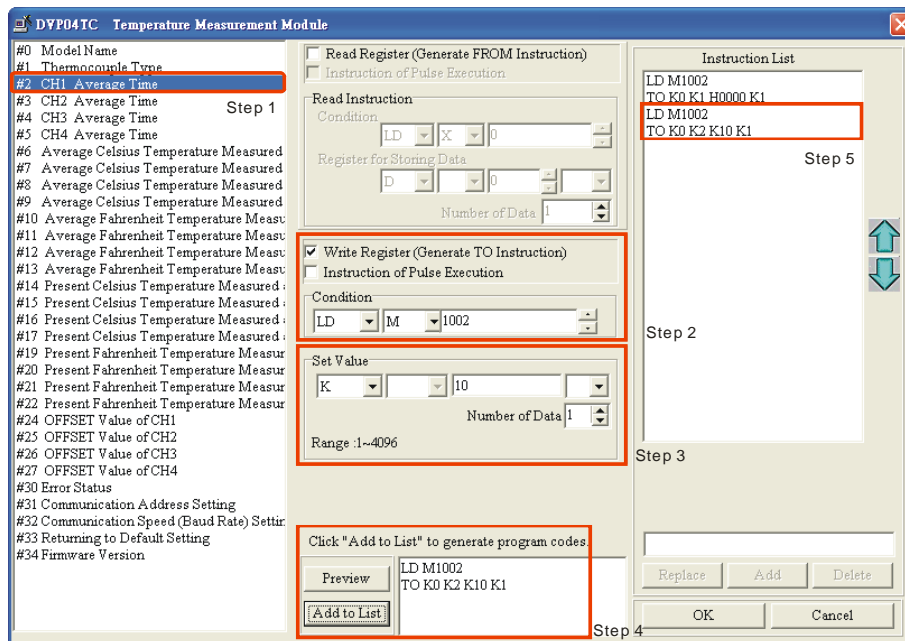

6. Setting up CR#6 ~ CR#9 is similar to the setup of CR#2 ~ CR#5.
 - Step 1: Select "#6 Average Celsius Temperature Measured at CH1"
 - Step 2: Check "Read Register" to generate FROM instruction. Set the condition as "LD M1000".
 - Step 3: Set the register for storing data as "D20" and number of data as "4".
 - Step 4: Click "Preview" to check if the generated program codes are correct.

5 Temperature Measurement Module DVP04TC-E2

Step 5: Click “Add to List” to display the instruction codes in “Instruction List”. The setup of CR#6 ~ CR#9 is completed.

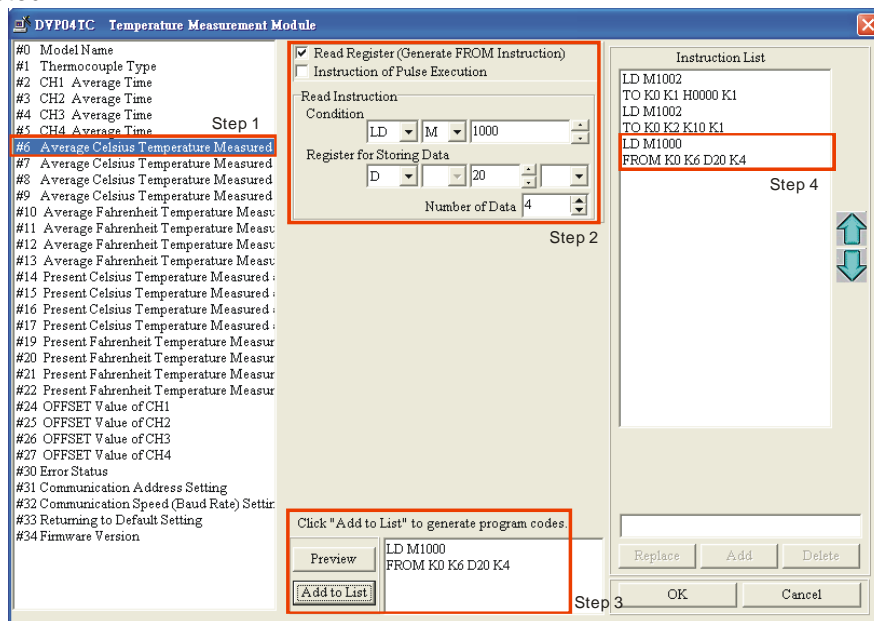

7. The setup of other CR parameters can follow the steps illustrated above.
8. After you complete all the setups, click on “OK” to return to the “Auxiliary Design of Extension Module” window and continue to set up other modules.

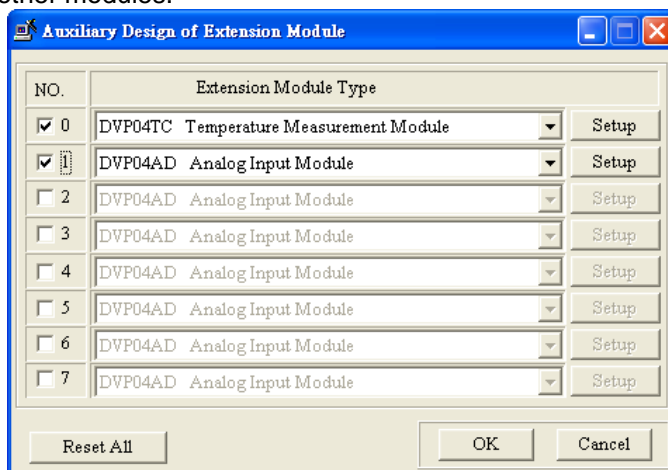

9. After you complete the setups of all the modules, click on “OK” to generate the program below.

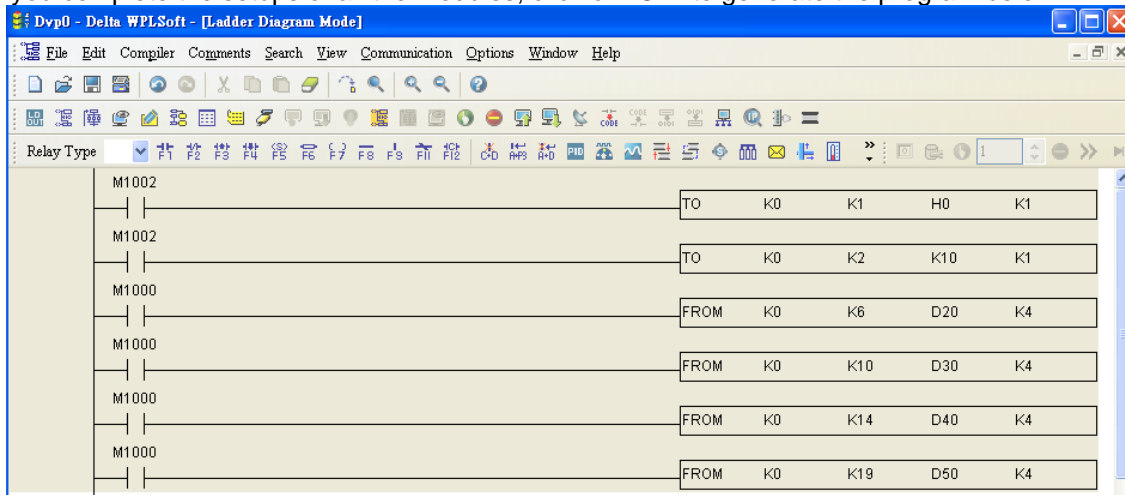

10. If you need to add in other control programs, you can edit the program directly in the ladder diagram window in WPLSoft.

5.9 PID Functions

5.9.1 Introduction to PID

- P (Proportional) Control

The proportional control refers to that the output is in proportional to the error. When the temperature is lower than the proportional band and the output is 100%, the control will enter the proportional band, and the output will be gradually in smaller proportional to the error. When the set temperature value (SV) is consistent with the present temperature value (PV), i.e. no error, the output will be 0%. (Error = SV - PV)

In a heater: SV = 1,000 (100°C), $K_P = 100$ (10°C). See the figure below for the relation between temperature and output.

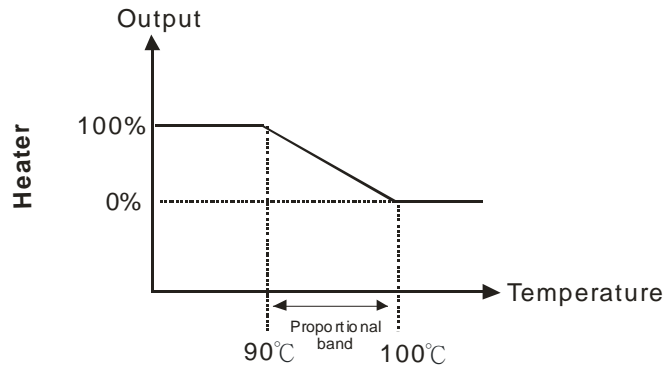

In a cooler: SV = 200 (20°C), $K_P = 100$ (10°C). See the figure below for the relation between temperature and output.

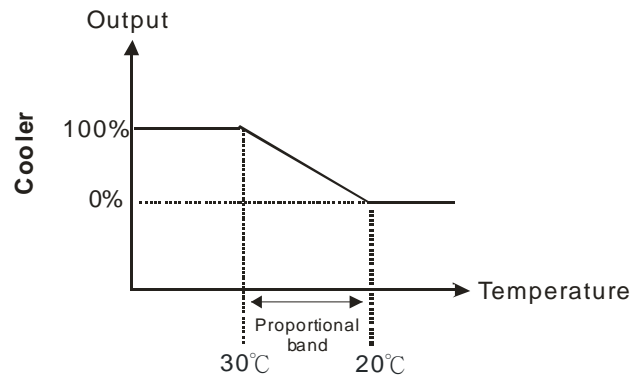

- I (Integral) Control

With only P control, the controlled temperature will be deviated in a certain level from the set temperature. Therefore, we adopt integral control with the proportional control. As time passes by, the deviation of value will disappear, and the controlled temperature will be consistent with the set temperature.

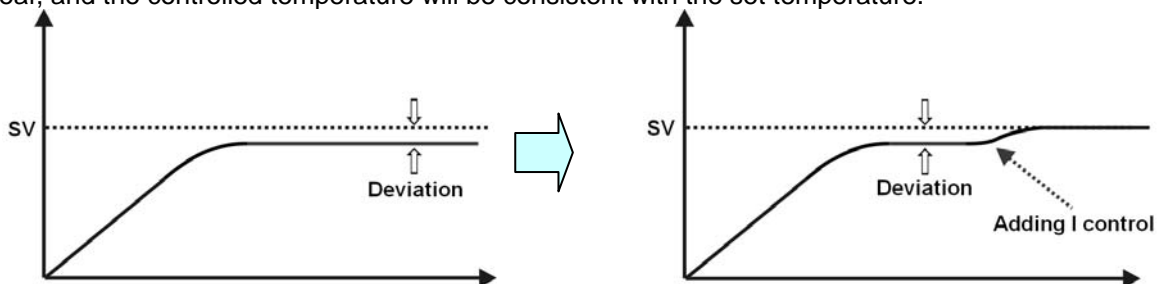

5 Temperature Measurement Module DVP04TC-E2

- D (Derivative) Control
The derivative control is capable of offering bigger output in response to strong interference and restoring the control to its original status.

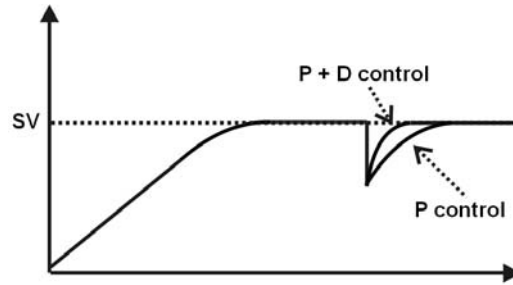

- Control Chart

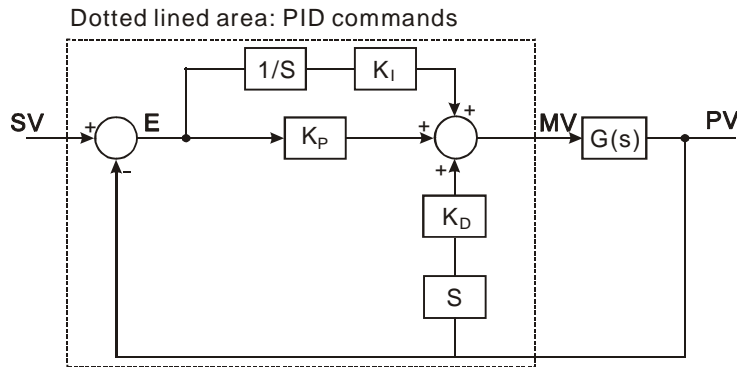

Symbol explanation:

MV : Output value

K_p : Proportional gain

$E(t)$: Error value

PV : Present measured value

SV : Target value

K_D : Differential gain

$PV(t)S$: Differential value of $PV(t)$

K_I : Integral gain

$E(t)\frac{1}{S}$: Integral value of $E(t)$

Basic PID Operation Formula

$$MV = \frac{1}{K_p} \left[E(t) + \frac{1}{K_I} \left(E(t) \frac{1}{S} \right) + K_D * PV(t)S \right]$$

In which the error is fixed to: $E = SV - PV$

To avoid the sudden derivative value that is too big caused by the activation of PID command for the first time, we therefore adopt the differentiation of PV.

5.9.2 PID Control Modes

DVP04TC-E2 offers 3 types of control modes for the PID control.

1. Percentage Control Mode (CR: output percentage)

Application 1:

If the heater or cooler you are using is controlled by a power switch (On/Off), you can read out the output percentage (0~100%) from DVP04TC-E2 and adopt GPWM instruction as a cyclic control. Please refer to the wiring method below:

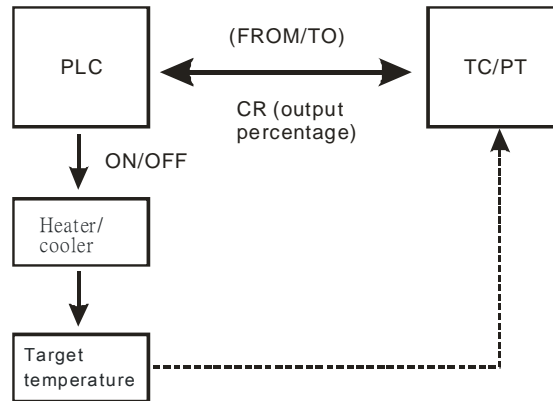

Example:

Connect the sensor to CH1 of DVP04TC-E2 and use FROM instruction to read the output percentage (CR#131). Connect the heater/cooler with Y0 and apply GPWM instruction to control the cyclic output.

PLC program description:

1. Read CR#131 (CH1 output percentage)
2. If output percentage D10=500 and output cycle D20=2000, width of output pulse D22 (t)=output cycle(T) × CR#131 / 1000 (unit: 0.1%) = D20 × D10 / 1000 = 2000 × 500/1000=1000
3. Apply GPWM instruction to control the output pulse width and output cycle so as to control the connected heater/cooler.
4. Program:

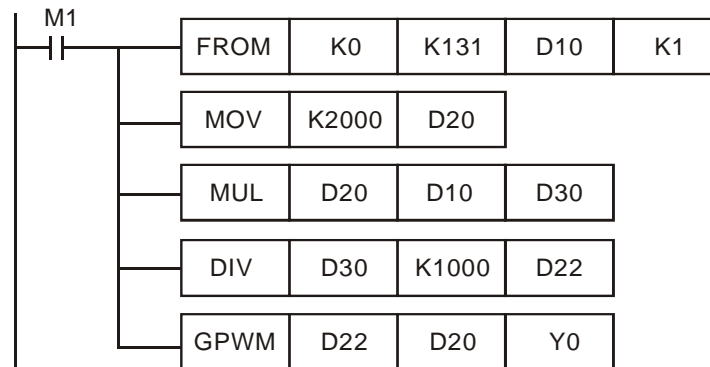

5. Diagram of output pulse:

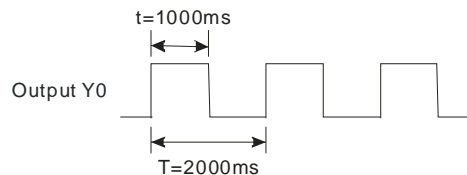

5 Temperature Measurement Module DVP04TC-E2

Application 2:

If the heater or cooler you are using is controlled by voltage or current, you can read out the output percentage (0~100%) from DVP04TC-E2 and adopt analog output function provided by DVP04DA-E2. Please refer to the wiring method below:

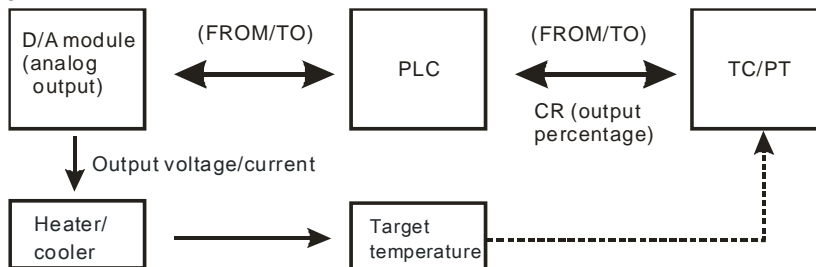

Example:

Connect the sensor to CH1 of DVP04TC-E2 and couple PLC with analog output module DVP04DA-E2. Connect the heater/cooler with voltage/current output channel of DVP04DA-E2. Output range of heater/cooler: 0V~10V (0~32000)

PLC program description :

1. Read CR#131 (CH1 output percentage)
2. Calculate the analog output value. Analog output value = $32000 \times CR\#131 / 1000$ (unit: 0.1%) = $32 \times D10$.
3. Sent the obtained value to D9910 for DVP04DA-E2 to control voltage/current output so as to control the heater/cooler.
4. Program:

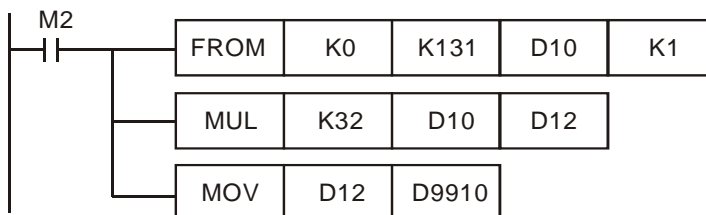

5. The relation between digital input and output voltage:

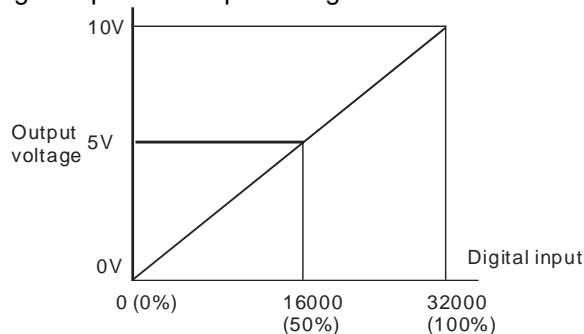

2. Cyclic Control Mode (CR: output width, output cycle)

If the heater or cooler you are using is controlled by a power switch (On/Off), other than percentage control mode you can also read two control registers (CR) from the DVP04TC-E2 module and adopt GPWM instruction as a cyclic control. Please refer to the wiring method below:

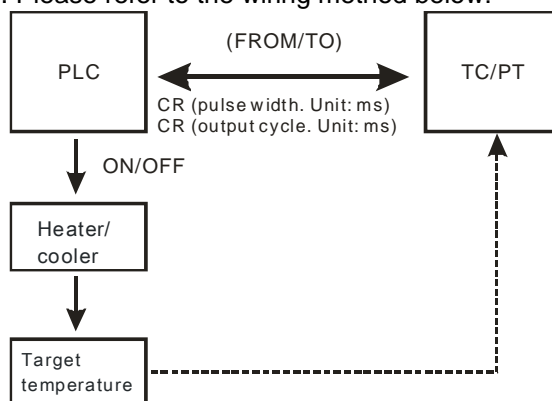

Example:

The sensor receives signals from CH1 of DVP04TC-E2. The output width of CH1 is read in CR#132, and the output cycle of CH1 is read in CR#133. Use FROM instruction to read CR#132 and CR#133 and conduct the cyclic control by the output width and cycle contained in GPWM instruction. Connect the heater/cooler with PLC Y0 to execute the output.

PLC program description:

1. Read CR#132 for output width of CH1 and CR#133 output cycle of CH1. Store the obtain value in D10 and D11.
2. Apply GPWM instruction to control the output pulse width (D10) and output cycle (D11) so as to control the connected heater/cooler.
3. Program:

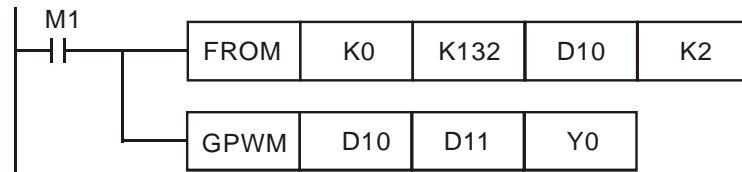

4. Assume the pulse width is 1,000 and output cycle is 2,000, the output pulse diagram will be:

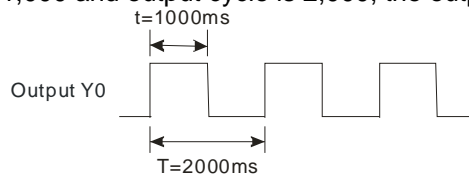

3. Analog Output Mode (CR: output volume)

If the heater or cooler you are using is controlled by voltage or current, you can read the CR which stores digital output volume of the specified channel from DVP04TC-E2 and adopt analog output function provided by DVP04DA-E2. Please refer to the wiring method below:

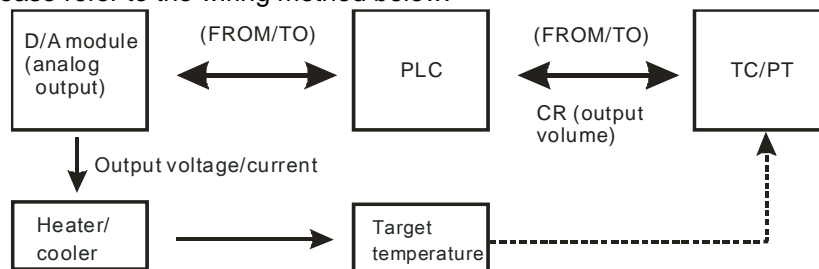

To control the heater or cooler by analog output mode, you have to set up the CR in DVP04TC-E2 which stores the range of digital output. In addition, use FROM instruction to read the CR which stores output volume and TO instruction to send the output volume to the analog output module.

Example:

Use the heater/cooler with DVP04DA-E2 to conduct analog output. The heater/cooler is connected to the current output channel of DVP04DA-E2. Output range of heater/cooler: 0 ~ 32,000 (4 ~ 20mA). We set up the upper limit (32,000) and lower limit (0) of output volume and use FROM instruction to read the digital output value from DVP04TC-E2 to D10 and sent the content in D10 to D9910 to conduct output from DVP04DA-E2.

PLC program description:

1. Before executing the program, set CR#129 (upper limit of output volume) as 32000; CR#130 (lower limit of output volume) as 0.
2. Read the content in CR#134 (output volume) to D10
3. Sent the value in D10 to D9910 to perform analog output.

5 Temperature Measurement Module DVP04TC-E2

4. Program:



5. The relation between digital input and output current:

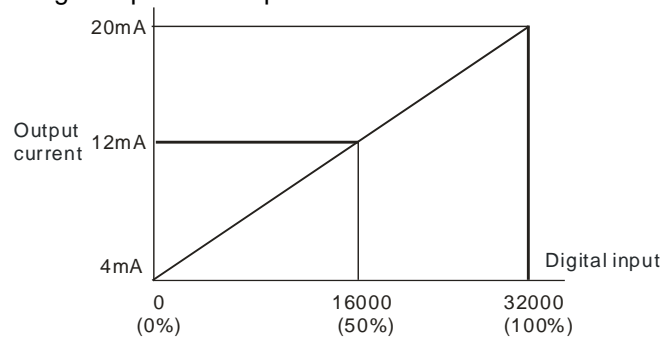

5.9.3 PID Application Example

Targets:

1. Set up target temperature.
2. Set up "auto-tuning", enable PID function and wait for the completion of "auto-tuning"
3. Once the "auto-tuning" is completed, you only need to enable manual PID for the next time.

Enable M100 to set up target temperature in D500.



Read average temperature at CH1 every 1 second.



Set up PID auto-tuning and PID RUN at M0.

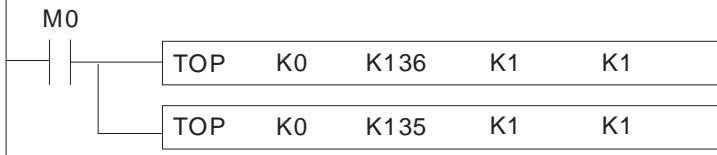

Set up PID in manual mode and PID RUN at M1.

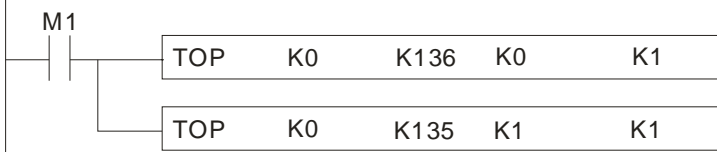

Read output width, output cycle and execute GPWM pulse width adjustment instruction.

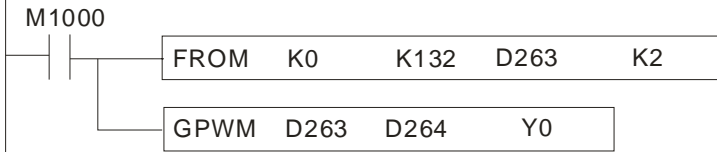

Auto-tuning: CR#136 = K0 indicates that the auto-tuning is completed. Once the auto-tuning is completed, read K_p , K_i and K_d .

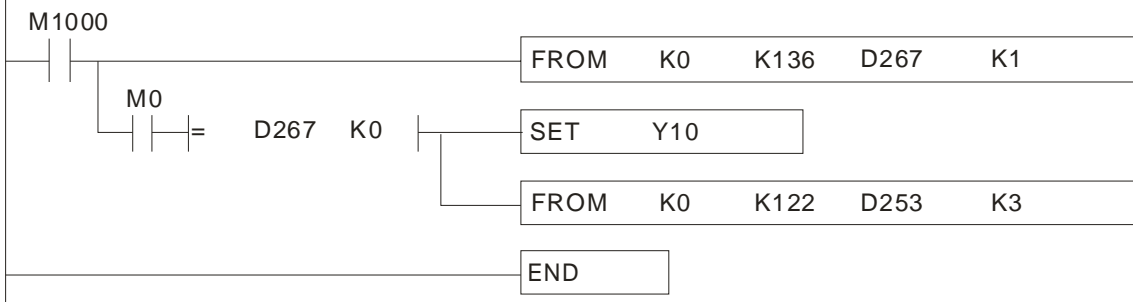

5.10 Hardware Properties of Temperature Controllers

- DVP04TC-E2 and temperature controllers of other brands need 20 ~ 30 minutes of warm-up time. The higher the ambient temperature, the longer warm-up time required.
- For ensuring hardware performance, each sensor channel can only be adjusted after the module is warmed up. The error in sensor varies upon different brands. We suggest you choose a high quality sensor for achieving higher accuracy on temperature measurement.
- Simple test can be conducted by users for checking the function of each channel.
 1. Short-circuit the channel you are using, and the measured temperature should be the temperature currently inside the module, i.e. the CJC temperature (CR#29). For instance, if the current temperature is 26 degree, connect the positive end of CH1 to the negative end (0v), i.e. short-circuit the channel, and the measured temperature should approach 26 degree.
 2. In addition, input 21.848mv to the channel and the measured temperature should be 400 degree plus the measured temperature in short circuit condition. For example, given the temperature measured in short circuit condition is 26 degree, when the channel receives input as 21.848mV, the measured temperature should be 426 degree.
 3. If the test results are consistent with the above description (the channel operates in good condition) but errors still exist, please check other factors which could possibly influence normal operation of the temperature controller.

MEMO