



Contactor AC 24 V 50/60 HZ AC3 7.5 kW 400 V AUX contacts 1 NC 3-pole, size S00 screw terminal

<b>product brand name</b>	SIRIUS
<b>product designation</b>	Power contactor
<b>product type designation</b>	3RT6
<b>General technical data</b>	
<b>size of contactor</b>	S00
product extension auxiliary switch	Yes
<b>power loss [W] for rated value of the current</b>	
• at AC in hot operating state per pole	2.2 W
• without load current share typical	1.42 W
<b>type of calculation of power loss current-dependent</b>	quadratic
<b>insulation voltage rated value</b>	690 V
<b>degree of pollution</b>	3
<b>surge voltage resistance rated value</b>	6 kV
maximum permissible voltage for protective separation between coil and main contacts according to EN 60947-1	400 V
<b>shock resistance at rectangular impulse</b>	
• at AC	7,3 g / 5 ms, 4,7 g / 10 ms
<b>shock resistance with sine pulse</b>	
• at AC	11,4 g / 5 ms, 7,3 g / 10 ms
<b>mechanical service life (operating cycles)</b>	
• of contactor typical	30 000 000
• of the contactor with added auxiliary switch block typical	10 000 000
<b>Substance Prohibition (day/month/year)</b>	05/01/2012
<b>Net Weight</b>	0.22 kg
<b>Ambient conditions</b>	
installation altitude at height above sea level maximum	2 000 m
<b>ambient temperature</b>	
• during operation	-25 ... +60 °C
• during storage	-55 ... +80 °C
<b>Main circuit</b>	
<b>number of poles for main current circuit</b>	3
<b>number of NO contacts for main contacts</b>	3
<b>number of NC contacts for main contacts</b>	0
<b>operating voltage</b>	
• at AC-3 rated value maximum	690 V
• at AC-3e rated value maximum	690 V
<b>operational current</b>	
• at AC-1 up to 690 V	
— at ambient temperature 40 °C rated value	22 A

<ul style="list-style-type: none"> <li>— at ambient temperature 60 °C rated value</li> </ul>	20 A
<ul style="list-style-type: none"> <li>● at AC-3 <ul style="list-style-type: none"> <li>— at 400 V rated value</li> <li>— at 690 V rated value</li> </ul> </li> </ul>	16 A 8.9 A
<ul style="list-style-type: none"> <li>● at AC-3e <ul style="list-style-type: none"> <li>— at 400 V rated value</li> <li>— at 690 V rated value</li> </ul> </li> </ul>	16 A 8.9 A
<b>connectable conductor cross-section in main circuit at AC-1</b>	
<ul style="list-style-type: none"> <li>● at 60 °C minimum permissible</li> <li>● at 40 °C minimum permissible</li> </ul>	2.5 mm <sup>2</sup> 4 mm <sup>2</sup>
<b>operational current for approx. 200000 operating cycles at AC-4</b>	
<ul style="list-style-type: none"> <li>● at 400 V rated value</li> <li>● at 690 V rated value</li> </ul>	5.5 A 4.4 A
<b>operating power</b>	
<ul style="list-style-type: none"> <li>● at AC-1 <ul style="list-style-type: none"> <li>— at 230 V rated value</li> <li>— at 230 V at 60 °C rated value</li> <li>— at 400 V at 60 °C rated value</li> <li>— at 690 V at 60 °C rated value</li> </ul> </li> <li>● at AC-3 <ul style="list-style-type: none"> <li>— at 230 V rated value</li> <li>— at 400 V rated value</li> <li>— at 690 V rated value</li> </ul> </li> <li>● at AC-3e <ul style="list-style-type: none"> <li>— at 230 V rated value</li> <li>— at 400 V rated value</li> <li>— at 690 V rated value</li> </ul> </li> </ul>	7.5 kW 7.5 kW 13 kW 22 kW 4 kW 7.5 kW 7.5 kW 4 kW 7.5 kW 7.5 kW
<b>operating power for approx. 200000 operating cycles at AC-4</b>	
<ul style="list-style-type: none"> <li>● at 400 V rated value</li> <li>● at 690 V rated value</li> </ul>	2.5 kW 3.5 kW
<b>no-load switching frequency</b>	
<ul style="list-style-type: none"> <li>● at AC</li> </ul>	10 000 1/h
<b>operating frequency</b>	
<ul style="list-style-type: none"> <li>● at AC-1 maximum</li> <li>● at AC-3 maximum</li> <li>● at AC-3e maximum</li> <li>● at AC-4 maximum</li> </ul>	1 000 1/h 750 1/h 750 1/h 250 1/h
<b>Control circuit/ Control</b>	
<b>type of voltage of the control supply voltage</b>	AC
<b>control supply voltage at AC</b>	
<ul style="list-style-type: none"> <li>● at 50 Hz rated value</li> <li>● at 60 Hz rated value</li> </ul>	24 V 24 V
<b>operating range factor control supply voltage rated value of magnet coil at AC</b>	
<ul style="list-style-type: none"> <li>● at 50 Hz</li> <li>● at 60 Hz</li> </ul>	0.8 ... 1.1 0.85 ... 1.1
<b>apparent pick-up power of magnet coil at AC</b>	
<ul style="list-style-type: none"> <li>● at 50 Hz</li> <li>● at 60 Hz</li> </ul>	37 VA 43 VA
<b>inductive power factor with closing power of the coil</b>	
<ul style="list-style-type: none"> <li>● at 50 Hz</li> <li>● at 60 Hz</li> </ul>	0.8 0.8
<b>apparent holding power of magnet coil at AC</b>	
<ul style="list-style-type: none"> <li>● at 50 Hz</li> <li>● at 60 Hz</li> </ul>	5.7 VA 6.5 VA
<b>inductive power factor with the holding power of the coil</b>	
<ul style="list-style-type: none"> <li>● at 50 Hz</li> </ul>	0.25

<ul style="list-style-type: none"> <li>at 60 Hz</li> </ul>	0.25
<b>Auxiliary circuit</b>	
number of NC contacts for auxiliary contacts instantaneous contact	1
number of NO contacts for auxiliary contacts instantaneous contact	0
operational current at AC-12 maximum	10 A
<b>operational current at AC-15</b>	
<ul style="list-style-type: none"> <li>at 230 V rated value</li> <li>at 400 V rated value</li> <li>at 690 V rated value</li> </ul>	10 A 3 A 1 A
<b>operational current at DC-12</b>	
<ul style="list-style-type: none"> <li>at 24 V rated value</li> <li>at 110 V rated value</li> <li>at 220 V rated value</li> </ul>	6 A 3 A 1 A
<b>operational current at DC-13</b>	
<ul style="list-style-type: none"> <li>at 24 V rated value</li> <li>at 110 V rated value</li> <li>at 220 V rated value</li> </ul>	6 A 1 A 0.3 A
<b>contact reliability of auxiliary contacts</b>	1 faulty switching per 100 million (17 V, 1 mA)
<b>UL/CSA ratings</b>	
yielded mechanical performance [hp] for 3-phase AC motor at 460/480 V rated value	10 hp
<b>Short-circuit protection</b>	
<b>design of the fuse link</b>	
<ul style="list-style-type: none"> <li>for short-circuit protection of the main circuit <ul style="list-style-type: none"> <li>with type of coordination 1 required</li> <li>with type of coordination 2 required</li> </ul> </li> <li>for short-circuit protection of the auxiliary switch required</li> </ul>	gL/gG LV HRC 3NA, DIAZED 5SB, NEOZED 5SE: 35 A gL/gG LV HRC 3NA, DIAZED 5SB, NEOZED 5SE: 20 A fuse gL/gG: 10 A
<b>Installation/ mounting/ dimensions</b>	
<b>mounting position</b>	+/-180° rotation possible on vertical mounting surface; can be tilted forward and backward by +/- 22.5° on vertical mounting surface
fastening method side-by-side mounting	Yes
<b>fastening method</b>	screw and snap-on mounting onto 35 mm DIN rail according to DIN EN 50022
<b>height</b>	57.5 mm
<b>width</b>	45 mm
<b>depth</b>	73 mm
<b>required spacing</b>	
<ul style="list-style-type: none"> <li>with side-by-side mounting <ul style="list-style-type: none"> <li>at the side</li> </ul> </li> </ul>	0 mm
<b>Connections/ Terminals</b>	
<b>type of electrical connection</b>	
<ul style="list-style-type: none"> <li>for main current circuit</li> <li>for auxiliary and control circuit</li> </ul>	screw-type terminals screw-type terminals
type of connectable conductor cross-sections for main contacts	
<ul style="list-style-type: none"> <li>solid or stranded</li> <li>finely stranded with core end processing</li> </ul>	2x (0,5 ... 1,5 mm <sup>2</sup> ), 2x (0,75 ... 2,5 mm <sup>2</sup> ), 2x 4 mm <sup>2</sup> 2x (0.5 ... 1.5 mm <sup>2</sup> ), 2x (0.75 ... 2.5 mm <sup>2</sup> )
<b>type of connectable conductor cross-sections</b>	
<ul style="list-style-type: none"> <li>for auxiliary contacts <ul style="list-style-type: none"> <li>solid or stranded</li> <li>finely stranded with core end processing</li> </ul> </li> <li>for AWG cables for auxiliary contacts</li> </ul>	2x (0.5 ... 1.5 mm <sup>2</sup> ), 2x (0.75 ... 2.5 mm <sup>2</sup> ), 2x 4 mm <sup>2</sup> 2x (0.5 ... 1.5 mm <sup>2</sup> ), 2x (0.75 ... 2.5 mm <sup>2</sup> ) 2x (20 ... 16), 2x (18 ... 14), 2x 12
<b>Safety related data</b>	
product function mirror contact according to IEC 60947-4-1	Yes
<b>Electrical Safety</b>	
<b>protection class IP on the front according to IEC 60529</b>	IP20
<b>touch protection on the front according to IEC 60529</b>	finger-safe, for vertical contact from the front
<b>Approvals Certificates</b>	
<b>General Product Approval</b>	



[Confirmation](#)



EG-Konf.

EMV	Maritime application	other	Environment
-----	----------------------	-------	-------------



[CCS \(China Classification Society\)](#)

[Confirmation](#)



[Environmental Confirmations](#)

**Further information**

Service&Support (Manuals, Certificates, Characteristics, FAQs,...)

<https://support.industry.siemens.com/cs/products?pnid=16027&lc=en-CN>

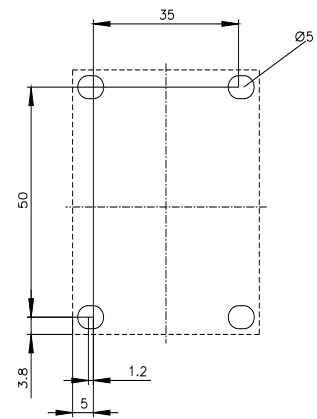
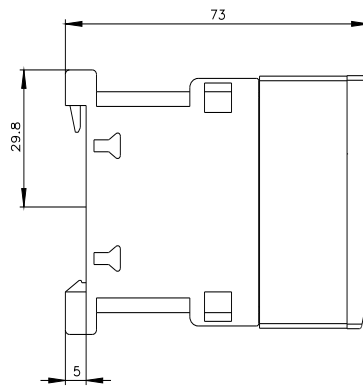
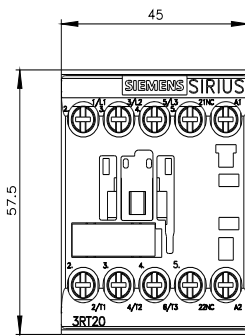

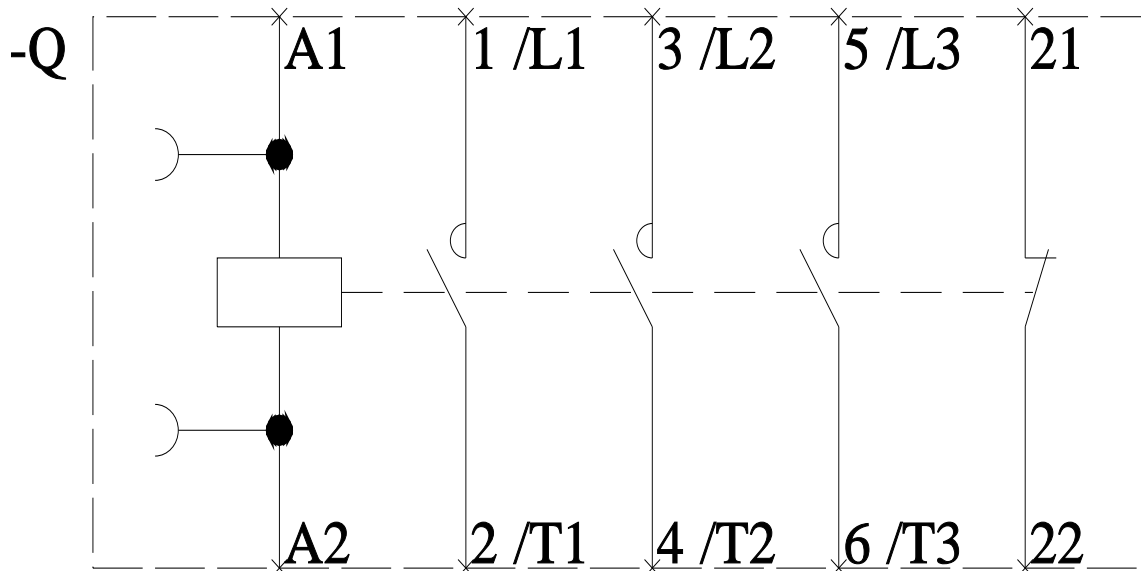

last modified:

4/4/2026 