

Product data sheet

Characteristics

XUM9APCNM8

photo-electric sensor - XUM - polarised - Sn 5m - 12..24VDC - M8

Product availability : Stock - Normally stocked in distribution facility

Price* : 67.20 USD



Main

Range of product	OsiSense XU
Series name	General purpose single mode
Electronic sensor type	Photo-electric sensor
Sensor name	XUM
Sensor design	Miniature
Detection system	Polarised reflex
Material	Plastic
Type of output signal	Discrete
Supply circuit type	DC
Wiring technique	3-wire
Discrete output type	PNP
Discrete output function	1 NO or 1 NC programmable
Electrical connection	1 male connector M8, 4 pins
Product specific application	-
Emission	Red polarised reflex
[Sn] nominal sensing distance	16.4 ft (5 m) polarised reflex need reflector XUZC50

Complementary

Enclosure material	PBT
Lens material	PMMA
Output type	Solid state
Wire insulation material	PVC
Status LED	1 LED (green) instability 1 LED (orange) output state
[Us] rated supply voltage	12...24 V DC with reverse polarity protection
Supply voltage limits	10...30 V DC
Switching capacity in mA	<= 100 mA (overload and short-circuit protection)
Switching frequency	<= 1000 Hz
Voltage drop	<= 2 V (closed state)
Current consumption	<= 10 mA (no-load)

Delay first up	< 100 ms
Delay response	< 1 ms
Delay recovery	0.5 ms
Setting-up	Sensitivity adjustment by potentiometer
Depth	0.79 in (20 mm)
Height	1.3 in (33 mm)
Length	0.43 in (11 mm)
Width	0.43 in (11 mm)
Product weight	0.04 lb(US) (0.02 kg)

Environment

Product certifications	CE cURus
Ambient air temperature for operation	-13...131 °F (-25...55 °C)
Ambient air temperature for storage	-22...158 °F (-30...70 °C)
Immunity to ambient light	3000 lux with natural light 3000 lux with incandescent light
Vibration resistance	20 gn, amplitude = +/- 1.5 mm (f = 10...500 Hz) conforming to IEC 60068-2-6
Shock resistance	50 gn (duration = 11 ms) conforming to IEC 60068-2-27
IP degree of protection	IP67 conforming to IEC 60529

Ordering and shipping details

Category	22415 - SENSORS, PHOTOELECTRIC, BASIC
Discount Schedule	DS2
GTIN	00785901590903
Nbr. of units in pkg.	1
Package weight(Lbs)	2.9999999999999999E-2
Returnability	N
Country of origin	TH

Offer Sustainability

RoHS (date code: YYWW)	Compliant - since 1152 - Schneider Electric declaration of conformity  Schneider Electric declaration of conformity
California proposition 65	WARNING: This product can expose you to chemicals including:
----- Substance 1	Diisononyl phthalate (DINP), which is known to the State of California to cause cancer, and
----- Substance 2	Di-isodecyl phthalate (DIDP), which is known to the State of California to cause birth defects or other reproductive harm.
----- More information	For more information go to www.p65warnings.ca.gov

Contractual warranty

Warranty period	18 months
-----------------	-----------

Dimensions

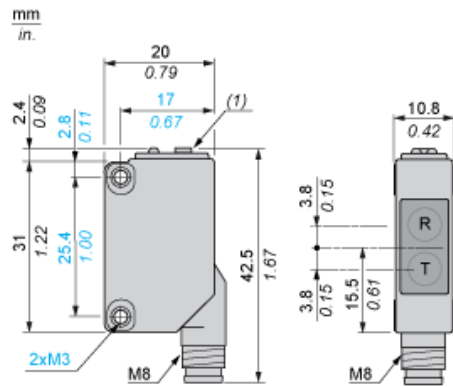

- R : Reception
- T : Transmission
- (1) Potentiometer

Mounting and Clearance

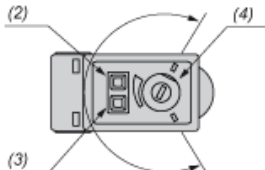
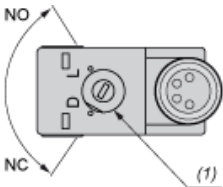

- (1) Configuration switch
- (2) Output state LED
- (3) Stability and power on LED
- (4) Adjustment potentiometer

Connections and Schemes

M8 Connector

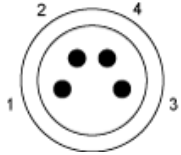

- 1 : (+)
- 3 : (-)
- 4 : OUT/Output

PNP

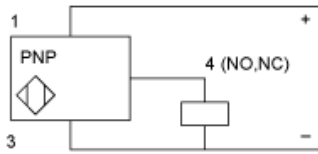

Detection Curves

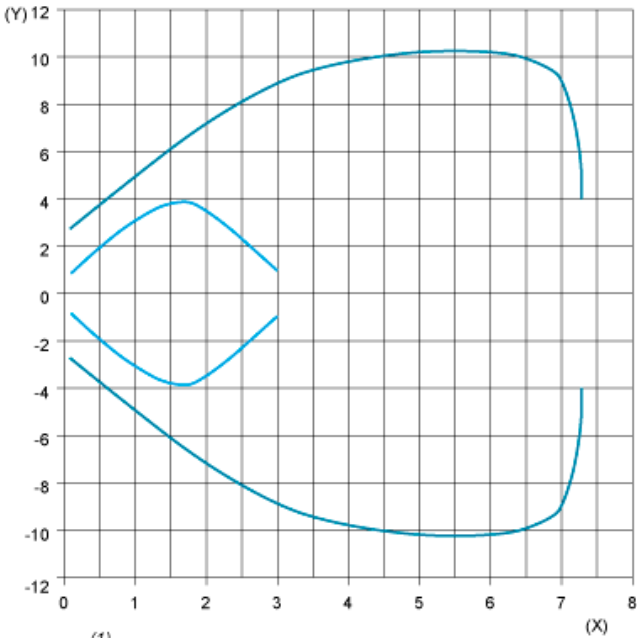

- (1) XUZC08
- (2) XUZC50
- (Y) Parallel movement (cm)
- (X) Distance (m)