



Contactor AC 36 V 50/60 HZ AC3 7.5 kW 400 V AUX contacts 1 NO 3-pole, size S00 screw terminal

product brand name	SIRIUS
product designation	Power contactor
product type designation	3RT6
General technical data	
size of contactor	S00
product extension auxiliary switch	Yes
power loss [W] for rated value of the current	
• at AC in hot operating state per pole	2.2 W
• without load current share typical	1.42 W
type of calculation of power loss current-dependent	quadratic
insulation voltage rated value	690 V
degree of pollution	3
surge voltage resistance rated value	6 kV
maximum permissible voltage for protective separation between coil and main contacts according to EN 60947-1	400 V
shock resistance at rectangular impulse	
• at AC	7,3 g / 5 ms, 4,7 g / 10 ms
shock resistance with sine pulse	
• at AC	11,4 g / 5 ms, 7,3 g / 10 ms
mechanical service life (operating cycles)	
• of contactor typical	30 000 000
• of the contactor with added auxiliary switch block typical	10 000 000
Substance Prohibition (day/month/year)	05/01/2012
Net Weight	0.22 kg
Ambient conditions	
installation altitude at height above sea level maximum	2 000 m
ambient temperature	
• during operation	-25 ... +60 °C
• during storage	-55 ... +80 °C
Main circuit	
number of poles for main current circuit	3
number of NO contacts for main contacts	3
number of NC contacts for main contacts	0
operating voltage	
• at AC-3 rated value maximum	690 V
• at AC-3e rated value maximum	690 V
operational current	
• at AC-1 up to 690 V	
— at ambient temperature 40 °C rated value	22 A

<ul style="list-style-type: none"> — at ambient temperature 60 °C rated value 	20 A
<ul style="list-style-type: none"> ● at AC-3 <ul style="list-style-type: none"> — at 400 V rated value — at 690 V rated value 	16 A 8.9 A
<ul style="list-style-type: none"> ● at AC-3e <ul style="list-style-type: none"> — at 400 V rated value — at 690 V rated value 	16 A 8.9 A
connectable conductor cross-section in main circuit at AC-1	
<ul style="list-style-type: none"> ● at 60 °C minimum permissible ● at 40 °C minimum permissible 	2.5 mm ² 4 mm ²
operational current for approx. 200000 operating cycles at AC-4	
<ul style="list-style-type: none"> ● at 400 V rated value ● at 690 V rated value 	5.5 A 4.4 A
operating power	
<ul style="list-style-type: none"> ● at AC-1 <ul style="list-style-type: none"> — at 230 V rated value — at 230 V at 60 °C rated value — at 400 V at 60 °C rated value — at 690 V at 60 °C rated value ● at AC-3 <ul style="list-style-type: none"> — at 230 V rated value — at 400 V rated value — at 690 V rated value ● at AC-3e <ul style="list-style-type: none"> — at 230 V rated value — at 400 V rated value — at 690 V rated value 	7.5 kW 7.5 kW 13 kW 22 kW 4 kW 7.5 kW 7.5 kW 4 kW 7.5 kW 7.5 kW
operating power for approx. 200000 operating cycles at AC-4	
<ul style="list-style-type: none"> ● at 400 V rated value ● at 690 V rated value 	2.5 kW 3.5 kW
no-load switching frequency	
<ul style="list-style-type: none"> ● at AC 	10 000 1/h
operating frequency	
<ul style="list-style-type: none"> ● at AC-1 maximum ● at AC-3 maximum ● at AC-3e maximum ● at AC-4 maximum 	1 000 1/h 750 1/h 750 1/h 250 1/h
Control circuit/ Control	
type of voltage of the control supply voltage	AC
control supply voltage at AC	
<ul style="list-style-type: none"> ● at 50 Hz rated value ● at 60 Hz rated value 	36 V 36 V
operating range factor control supply voltage rated value of magnet coil at AC	
<ul style="list-style-type: none"> ● at 50 Hz ● at 60 Hz 	0.8 ... 1.1 0.85 ... 1.1
apparent pick-up power of magnet coil at AC	
<ul style="list-style-type: none"> ● at 50 Hz ● at 60 Hz 	37 VA 43 VA
inductive power factor with closing power of the coil	
<ul style="list-style-type: none"> ● at 50 Hz ● at 60 Hz 	0.8 0.8
apparent holding power of magnet coil at AC	
<ul style="list-style-type: none"> ● at 50 Hz ● at 60 Hz 	5.7 VA 6.5 VA
inductive power factor with the holding power of the coil	
<ul style="list-style-type: none"> ● at 50 Hz 	0.25

<ul style="list-style-type: none"> • at 60 Hz 	0.25
Auxiliary circuit	
number of NC contacts for auxiliary contacts instantaneous contact	0
number of NO contacts for auxiliary contacts instantaneous contact	1
operational current at AC-12 maximum	10 A
operational current at AC-15	
<ul style="list-style-type: none"> • at 230 V rated value • at 400 V rated value • at 690 V rated value 	10 A 3 A 1 A
operational current at DC-12	
<ul style="list-style-type: none"> • at 24 V rated value • at 110 V rated value • at 220 V rated value 	6 A 3 A 1 A
operational current at DC-13	
<ul style="list-style-type: none"> • at 24 V rated value • at 110 V rated value • at 220 V rated value 	6 A 1 A 0.3 A
contact reliability of auxiliary contacts	1 faulty switching per 100 million (17 V, 1 mA)
UL/CSA ratings	
yielded mechanical performance [hp] for 3-phase AC motor at 460/480 V rated value	10 hp
Short-circuit protection	
design of the fuse link	
<ul style="list-style-type: none"> • for short-circuit protection of the main circuit <ul style="list-style-type: none"> — with type of coordination 1 required — with type of coordination 2 required • for short-circuit protection of the auxiliary switch required 	gL/gG LV HRC 3NA, DIAZED 5SB, NEOZED 5SE: 35 A gL/gG LV HRC 3NA, DIAZED 5SB, NEOZED 5SE: 20 A fuse gL/gG: 10 A
Installation/ mounting/ dimensions	
mounting position	+/-180° rotation possible on vertical mounting surface; can be tilted forward and backward by +/- 22.5° on vertical mounting surface
fastening method side-by-side mounting	Yes
fastening method	screw and snap-on mounting onto 35 mm DIN rail according to DIN EN 50022
height	57.5 mm
width	45 mm
depth	73 mm
required spacing	
<ul style="list-style-type: none"> • with side-by-side mounting <ul style="list-style-type: none"> — at the side 	0 mm
Connections/ Terminals	
type of electrical connection	
<ul style="list-style-type: none"> • for main current circuit • for auxiliary and control circuit 	screw-type terminals screw-type terminals
type of connectable conductor cross-sections for main contacts	
<ul style="list-style-type: none"> • solid or stranded • finely stranded with core end processing 	2x (0,5 ... 1,5 mm ²), 2x (0,75 ... 2,5 mm ²), 2x 4 mm ² 2x (0,5 ... 1,5 mm ²), 2x (0,75 ... 2,5 mm ²)
type of connectable conductor cross-sections	
<ul style="list-style-type: none"> • for auxiliary contacts <ul style="list-style-type: none"> — solid or stranded — finely stranded with core end processing • for AWG cables for auxiliary contacts 	2x (0,5 ... 1,5 mm ²), 2x (0,75 ... 2,5 mm ²), 2x 4 mm ² 2x (0,5 ... 1,5 mm ²), 2x (0,75 ... 2,5 mm ²) 2x (20 ... 16), 2x (18 ... 14), 2x 12
Safety related data	
product function mirror contact according to IEC 60947-4-1	Yes
Electrical Safety	
protection class IP on the front according to IEC 60529	IP20
touch protection on the front according to IEC 60529	finger-safe, for vertical contact from the front
Approvals Certificates	
General Product Approval	



[Confirmation](#)



EG-Konf.

EMV	Maritime application	other	Environment
-----	----------------------	-------	-------------



[CCS \(China Classification Society\)](#)

[Confirmation](#)



[Environmental Confirmations](#)

Further information

Service&Support (Manuals, Certificates, Characteristics, FAQs,...)
<https://support.industry.siemens.com/cs/products?pnid=16027&lc=en-CN>

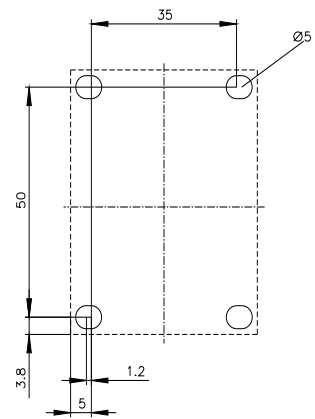
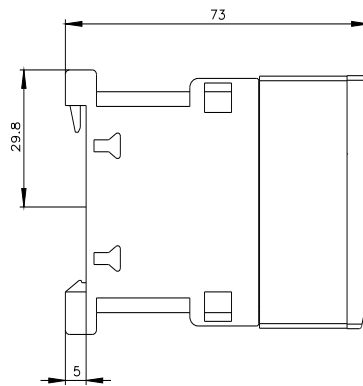
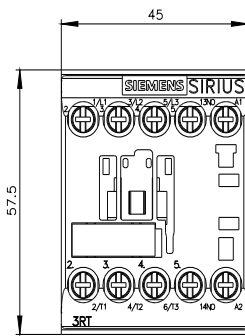

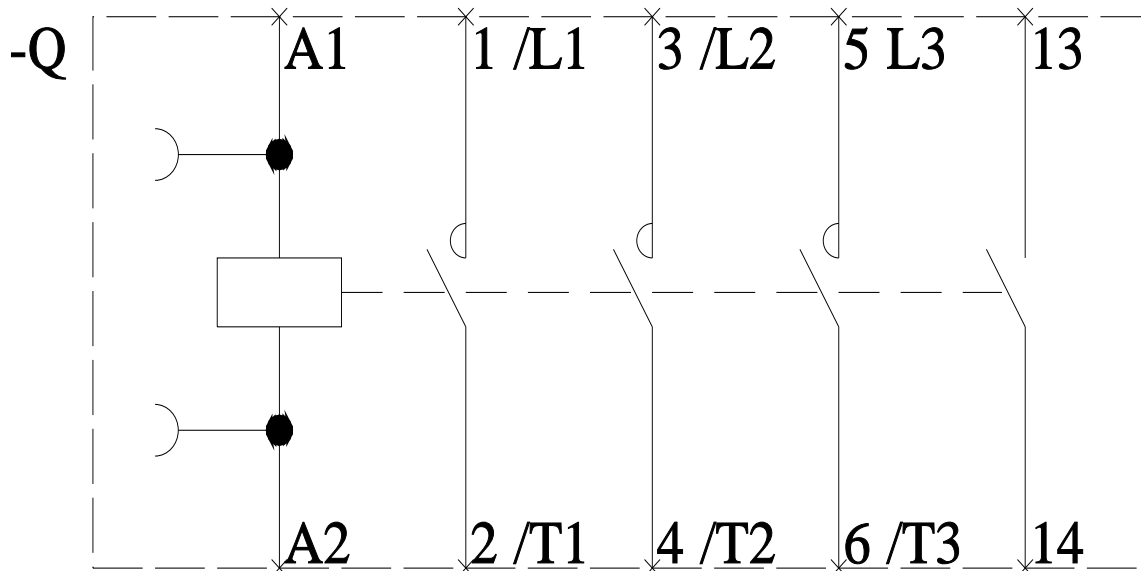
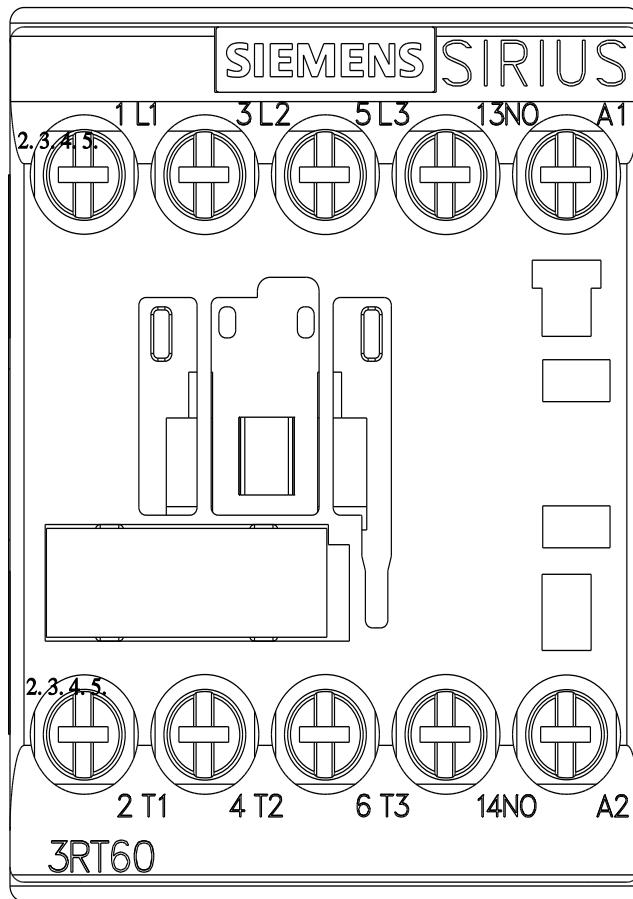

last modified:

4/4/2026 