

# Product data sheet

Specifications



variable speed drive, Altivar Machine ATV350, application I/O, fieldbus safety, 0.75kW, 1hp, 400 to 480V, IP54

ATV350U07N4FS

**Product availability: Stock - Normally stocked in distribution facility**

## Main

<b>Range of Product</b>	Altivar Machine ATV350
<b>Product Specific Application</b>	Material handling
<b>Product or Component Type</b>	Variable speed drive
<b>Device short name</b>	ATV350
<b>Variant</b>	Safety
<b>Product destination</b>	Asynchronous motors Synchronous motors
<b>Mounting Mode</b>	Wall mounted
<b>EMC filter</b>	Class C2 EMC filter integrated EN 61508 32.8 ft (10 m) Class C2 EMC filter integrated EN 61800-5-1 32.8 ft (10 m) Class C2 EMC filter integrated EN 61800-5-2 32.8 ft (10 m) Class C2 EMC filter integrated IEC 60529 32.8 ft (10 m) Class C2 EMC filter integrated UL 50E 32.8 ft (10 m) Class C2 EMC filter integrated machinery directive 2006/42/EC 32.8 ft (10 m)
<b>IP degree of protection</b>	IP54 conforming to EN 61508 IP54 conforming to EN 61800-5-1 IP54 conforming to EN 61800-5-2 IP54 conforming to IEC 60529 IP54 conforming to UL 50E IP54 conforming to machinery directive 2006/42/EC
<b>Type of cooling</b>	AN (air natural)
<b>Supply frequency</b>	45...65 Hz
<b>Phase</b>	3 phase with current derating of 2.5 % per °C
<b>[Us] rated supply voltage</b>	400...480 V +/-5 %
<b>Motor power kW</b>	0.75 kW conveying applications
<b>Maximum Horse Power Rating</b>	1 hp heavy duty
<b>Line current</b>	3.8 A 400...480 V conveying applications)
<b>Apparent power</b>	17.9 kVA 400...480 V conveying applications)
<b>Continuous output current</b>	3.8 A 2...16 kHz conveying applications
<b>Maximum transient current</b>	7.6 A 3 s conveying applications) 5.7 A 60 s conveying applications)
<b>Asynchronous motor control profile</b>	U/F vector control Sensorless vector control (SVC) Energy saving control Closed-loop control with encoder
<b>Synchronous motor control profile</b>	Permanent magnet control in open loop Permanent magnet control in close loop
<b>Output frequency</b>	1...599 Hz

Price is "List Price" and may be subject to a trade discount – check with your local distributor or retailer for actual price.

Nominal switching frequency	12 kHz
Switching frequency	2...16 kHz with current derating of 0.5 % per additional 100 m
number of preset speeds	16 preset speeds
Communication Port Protocol	EtherNet/IP EtherCAT IO-Link Modbus TCP PROFINET

## Complementary

Output voltage	460 V
Output Current	3.8 A
Motor slip compensation	Adjustable
Acceleration and deceleration ramps	2 customized adjustable ramps for acceleration and deceleration
Protection type	Line supply phase loss drive Motor phase loss motor Line supply overvoltage and undervoltage drive Overheating protection drive Overload motor With PTC probes motor Short-circuit between motor phases drive Overcurrent between output phases and earth drive
Frequency resolution	Motor 0.1 Hz
Electrical connection	2 connectors
Connector type	M12 I/O on base)EtherCAT M12 I/O on base)EtherNet/IP M12 I/O on base)Modbus TCP M12 I/O on base)PROFINET
Physical interface	2 Ethernet ports 100BASE-FX EtherNet/IP
Method of access	IO scanner
Supply	Internal supply for logic inputs 24 V DC
Local signalling	LEDs (red) for status
Discrete input number	8
Discrete input type	discrete input, 12 V DC
Input compatibility	1 incremental encoder (24 V)
Discrete input logic	Programmable digital input digital I/O, 0...0.8 V, 11...24 V
Isolation	Between power and control terminals
Safety Function	STO (safe torque off)
Width	20.6 in (522 mm)
Height	12.2 in (310 mm)
Depth	9.2 in (233 mm)
Product Weight	7.05 lb(US) (3.2 kg)

## Environment

Operating position	Horizontal
Pollution degree	2
Vibration resistance	1 mm (f= 5...13 Hz) conforming to DNVGL-GC-0339 0.7 gn (f= 13...100 Hz) conforming to DNVGL-GC-0339

<b>Relative humidity</b>	5...95 % without condensation EN/IEC 60068-2-3
<b>Ambient air temperature for operation</b>	-22...140 °F (-30...60 °C) (with current derating of 2.5 % per °C above 40 °C)
<b>Ambient Air Temperature for Storage</b>	-22...140 °F (-30...60 °C)
<b>Operating altitude</b>	3280.84 ft (1000 m) with current derating of 0.5 % per additional 100 m
<b>Standards</b>	IEC 61800-5-1 IEC 61800-3 UL 508C IEC 61800-3 environments 1 category C2 IEC 61800-3 environments 2 category C3 IEC 60721-3 IEC 61508 IEC 13849-1
<b>Product Certifications</b>	UL 508
<b>Marking</b>	CE UL CULus IEC UKCA

## Ordering and shipping details

<b>Category</b>	US1CP4B22182
<b>Discount Schedule</b>	CP4B
<b>GTIN</b>	3606487900306
<b>Returnability</b>	Yes
<b>Country of origin</b>	US

## Packing Units

<b>Unit Type of Package 1</b>	PCE
<b>Nbr. of units in pkg.</b>	1
<b>Package 1 Height</b>	9.500 in (24.130 cm)
<b>Package 1 Width</b>	12.600 in (32.004 cm)
<b>Package 1 Length</b>	21.500 in (54.610 cm)
<b>Package weight(Lbs)</b>	13.940 lb(US) (6.323 kg)



## Environmental Data

Schneider Electric aims to achieve Net Zero status by 2050 through supply chain partnerships, lower impact materials, and circularity via our ongoing “Use Better, Use Longer, Use Again” campaign to extend product lifetimes and recyclability.

[Environmental Data explained >](#)

[How we assess product sustainability >](#)

### Use Better

<b>Materials and Substances</b>	
Packaging made with recycled cardboard	Yes
Packaging without single use plastic	No
SCIP Number	Cc8e48eb-111a-43b0-b192-f59e8d006c75
EU RoHS Directive	<a href="#">Compliant By Exemption</a>
REACH Regulation	<a href="#">Reference contains Substances of Very High Concern above the threshold</a>
California proposition 65	<b>WARNING:</b> This product can expose you to chemicals including: Lead and lead compounds, which is known to the State of California to cause cancer and birth defects or other reproductive harm. For more information go to <a href="http://www.P65Warnings.ca.gov">www.P65Warnings.ca.gov</a>

### Use Longer

<b>Lifetime extension</b>	
Repair	No

### Use Again

<b>Repack and remanufacture</b>	
Take-back	No

Dimensions Drawings

Dimensions

mm  
in.

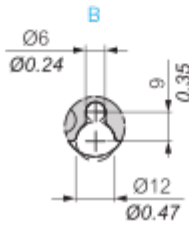
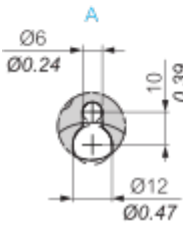
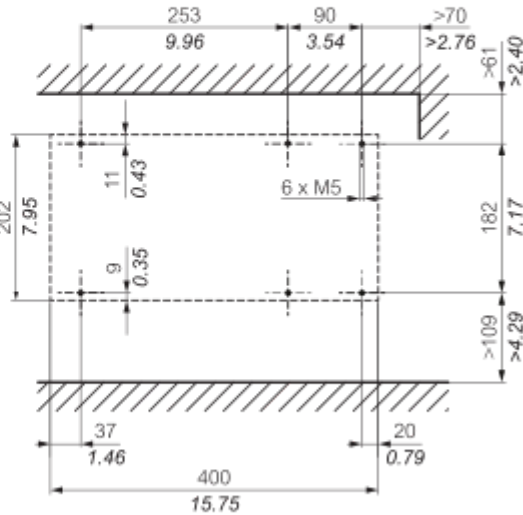
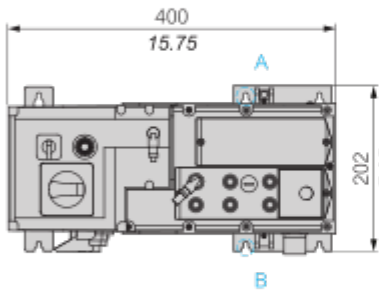
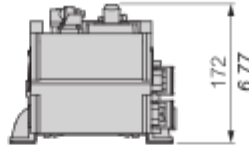
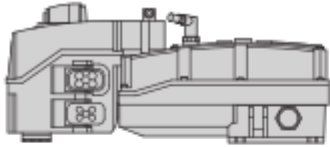

Connections and Schema

Wiring Diagram

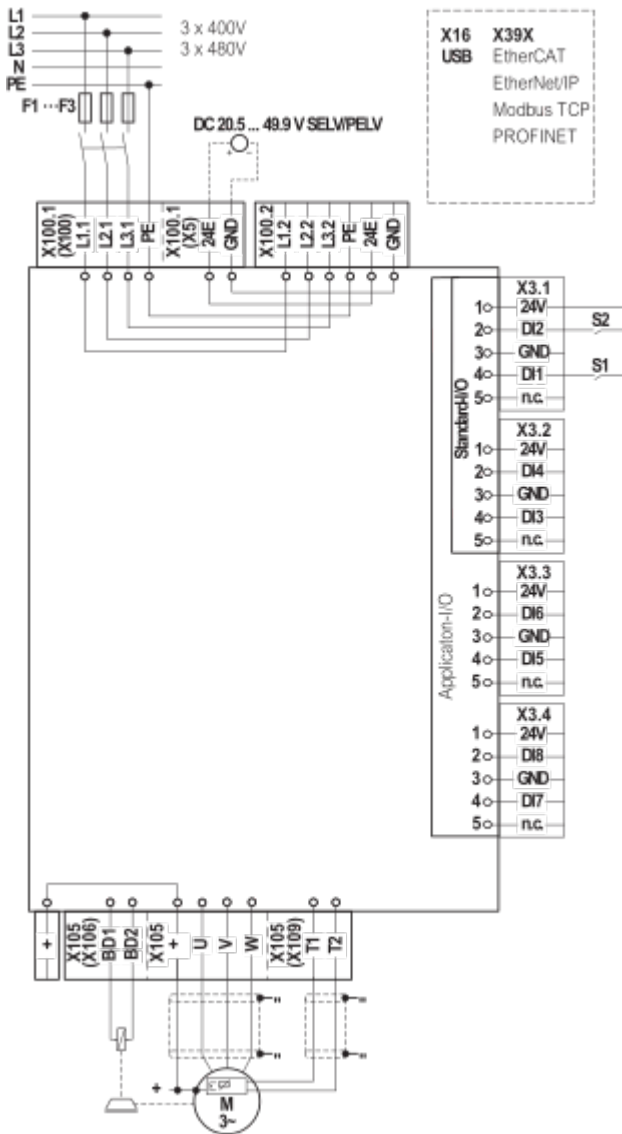

For the mains connection, the drive is equipped with Han-Q4/2 connectors.



Technical Illustration

Wiring diagram

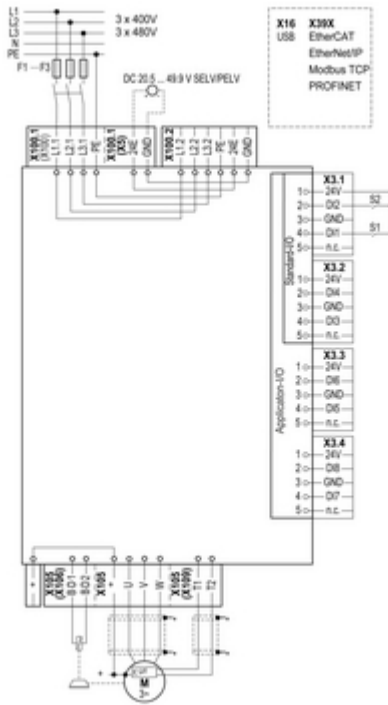

For the mains connection, the drive is equipped with Han-Q4/2 connectors.

Image of product / Alternate images

Alternative

---

