



High color • Wide screen •
User-friendly
No.18, Xinglong Rd., Taoyuan City
33068, Taiwan

DOP-110DS

Instruction Sheet

(1) General precautions

Thank you for purchasing this product. This DOP-107DV instruction sheet provides information for the DOP-107DV series HMI. Before using this product, read through this instruction sheet carefully to ensure the correct use of the product. Keep this sheet handy for quick reference whenever needed. Before finishing reading this sheet, follow the instructions below:

- Install the product in an indoor location, which is free of vapor and corrosive and inflammable gas.
- Refer to the wiring diagram when connecting the wires.
- Ensure this product is correctly grounded. The grounding method must comply with the national electrical standard guidelines (refer to NFPA 70: National Electrical Code, 2005 Ed.).
- Do not disassemble the HMI or change the wiring when power is on.
- Do not touch the power supply when power is on, or it may cause electric shock.
- When the HMI displays a low power notification and requires a battery change, contact Delta or local distributors for the replacement. Do not change the batteries by yourself.
- This product can be used with other industrial automation equipment. Read through this sheet carefully and install the product according to the instructions to avoid danger.
- Cleaning method: use a dry cloth to clean the product.
- This product must be used at an altitude below 2,000 m (6561.68 ft).
- If the equipment is used in a manner not specified by the manufacturer, the protection function provided by the equipment may be impaired.
- For repair and maintenance, contact Delta Electronics, Inc. Address: No.18, Xinglong Rd., Taoyuan City, Taiwan. TEL: +886-3-3626301.

If you have any inquiry during operation, contact our local distributors or Delta Customer Service Center. The instruction sheet may be revised without prior notice. Contact our distributors or download the latest version from the Delta website (<http://www.deltaww.com.tw/ia>).

(1) Précautions générales (FR)

Merci d'avoir acheté ce produit. Cette fiche d'instructions fournit des informations pour les IHM de la série DOP-103DQ. Avant d'utiliser ce produit, lisez attentivement cette fiche d'instructions pour assurer une utilisation correcte du produit. Gardez cette fiche à portée de main pour pouvoir vous y référer rapidement en cas de besoin. Avant de terminer la lecture de cette fiche, suivez ces instructions :

- Installez le produit dans un environnement exempt de vapeur, de gaz corrosifs et de gaz inflammables.
- Reportez-vous au schéma de câblage pour le raccordement des fils.
- Assurez-vous que ce produit est correctement mis à la terre. La méthode de mise à la terre doit être conforme aux directives des normes électriques nationales (voir NFPA 70 : National Electrical Code (Code électrique national), 2005 Ed.).
- Ne démontez pas l'IHM et ne changez pas le câblage, lorsque l'appareil est sous tension.
- Ne touchez pas à l'alimentation électrique lorsque l'appareil est sous tension, cela pourrait provoquer un choc électrique.
- Lorsque l'IHM affiche une information d'alimentation faible et nécessite un changement de batterie, contactez votre distributeur local ou le centre de service clientèle Delta pour le remplacement. Ne changez pas vous-même les batteries.
- Ce produit peut être utilisé avec d'autres équipements d'automatisation industrielle. Lisez attentivement cette fiche et installez le produit conformément aux instructions pour éviter tout danger.
- Méthode de nettoyage : nettoyez le produit à l'aide d'un chiffon sec.
- Utiliser ce produit à une altitude inférieure à 2 000 m (6,561.68 ft).
- Si l'équipement est utilisé d'une manière non spécifiée par le fabricant, la protection fournie par l'équipement risque d'être compromise.
- Pour les réparations et l'entretien, contactez Delta Electronics, Inc. Adresse : No. 18, Xinglong Rd., Taoyuan City, Taiwan. TÉL : +886-3-3626301.

Si vous avez des questions concernant le fonctionnement du programme, contactez nos distributeurs locaux ou le centre de service clientèle Delta. La fiche d'instructions peut être révisée sans préavis. Contactez nos distributeurs ou téléchargez la dernière version sur le site web de Delta à l'adresse <https://www.deltaww.com/>.

(2) Communication port pin assignment

DOP-110DS COM1

COM Port	Pin	MODE1		MODE2		MODE3	
		COM1	COM2	COM1	COM2	COM1	COM2
		RS-232	RS-485	RS-485	RS-485	RS-232	RS-422
	1	-	-	D+	-	-	TXD+
	2	RXD	-	-	-	RXD	-
	3	TXD	-	-	-	TXD	-
	4	-	D+	-	D+	-	RXD+
	5	GND		GND		GND	
	6	-	-	D-	-	-	TXD-
	7	RTS	-	-	-	RTS	-
	8	CTS	-	-	-	CTS	-
	9	-	D-	-	D-	-	RXD-

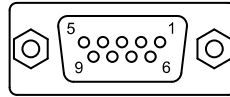

Note: the mark "-" means connection is not required.

(3) Description of each part

DOP-110DS (front view)

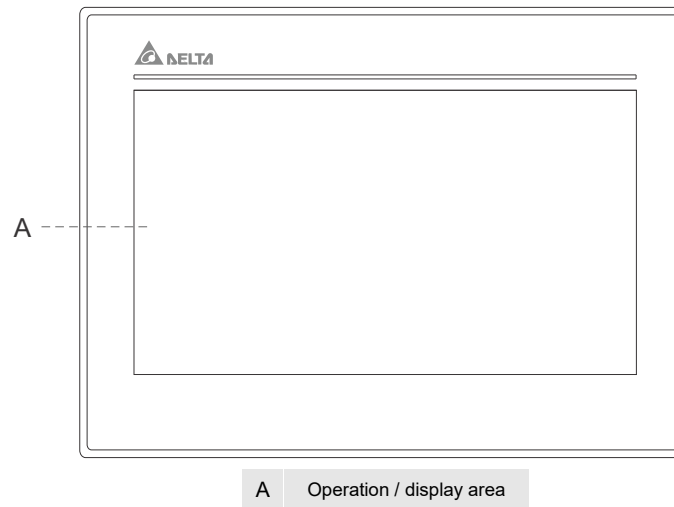

A Operation / display area

DOP-110DS (rear view)

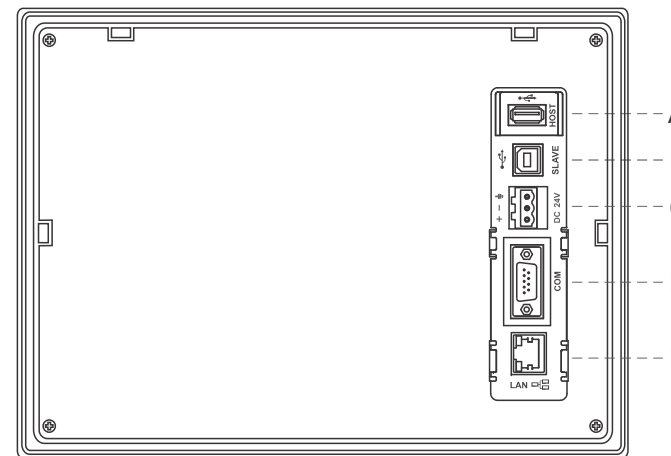

A	USB Host	B	USB Slave
C	Power input connector (24AWG wire min.)	D	COM
E	Ethernet (LAN)	-	-

(4) Mounting dimensions

DOP-110DS

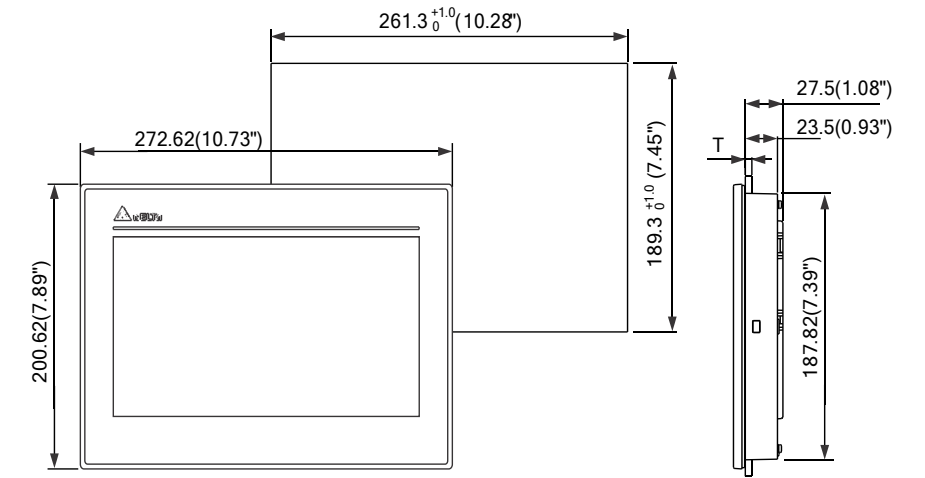

Note:
T=1.6 mm~6 mm(0.063"~0.24")

Operation temperature: 0°C to 50°C (32°F to 122°F)
Storage temperature: -20°C to 60°C (-4°F to 140°F)

Unit: mm (inch)

(5) Installation and wiring

Precautions:

- Mount the HMI according to the following illustration. Incorrect installation direction may result in malfunction.
- To ensure the HMI is well ventilated, make sure there is sufficient space between the HMI and the adjacent objects or walls.
- This product should be used on a case or platform which conforms to enclosure Type 4X standard (for indoor use only).
- The maximum panel thickness for mounting must be no greater than 5 mm (0.2 inches).
- Use copper wires.

(5) Installation et câblage (FR)

Précautions :

- Un sens d'installation incorrect peut entraîner un dysfonctionnement.
- Pour une bonne ventilation et un refroidissement optimal, laissez un espace suffisant entre l'IHM et les objets ou les parois adjacentes, une surchauffe peut entraîner un dysfonctionnement de l'appareil.
- Ce produit doit être utilisé sur des boîtiers de type 4X fabriqués pour une utilisation en intérieur.
- L'épaisseur maximale du panneau pour le montage ne doit pas dépasser 5 mm (0,2 pouce).
- Utilisez des fils de cuivre.

Installation diagram:

Step 1:
Put the waterproof gasket onto the HMI and then insert the HMI into the panel cutout.

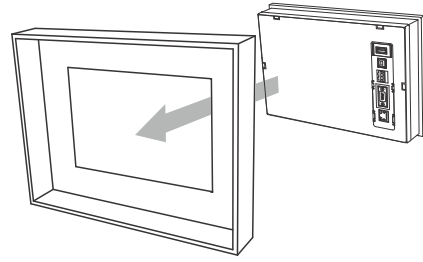

Step 2:
Place the fasteners into the slots and tighten the screws until reaching the panel cutouts.

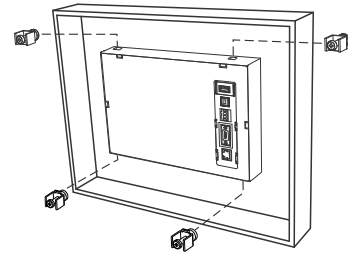

Step 3:
Tighten the screws with the torque between 0.5 N-M and 0.7 N-M to avoid damage to the plastic case.
DOP-110DS torque: 6.17 lb-inch (0.7 N-M)

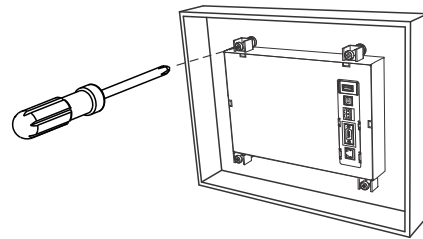

Step 4:
For heat dissipation, keep a minimum clearance of 60 mm (2.36 inches) and 45 mm (1.77 inches) respectively on the rear and bottom of the HMI.

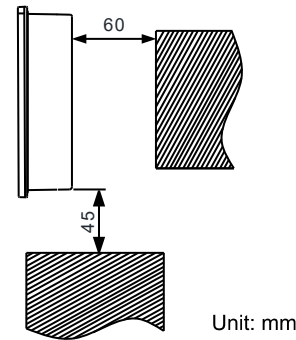

Unit: mm

Wiring:

Type	Wire gauge (AWG)	Stripped length	Torque
Solid	24 - 12	7 - 8 mm (0.28 - 0.31 inches)	5 kg-cm (4.3 lb-in)
Stranded	24 - 12	7 - 8 mm (0.28 - 0.31 inches)	5 kg-cm (4.3 lb-in)



Refer to the following diagram when wiring the power connector. The temperature rating of the cable must be greater than 75°C (167°F).

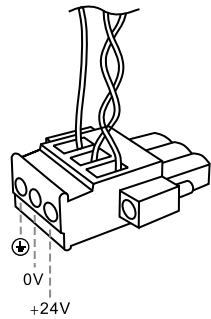

(6) Hardware specifications

Model		DOP-110DS
Display	Panel type	10.1" TFT LCD (24 bits colors)
	Resolution	1024 x 600 pixels
	Backlight	LED back light (half-life under room temperature 25°C > 30,000 hours) ¹
	Display range	222.72 mm * 125.28 mm
	Brightness	350 cd / m ² (Typ.)
CPU		ARM Cortex-A8 (800 MHz)
Flash ROM		256 Mbytes
RAM		256 Mbytes
Touchscreen		4-wire resistive touchscreen > 1,000,000 operated
Buzzer		Multi-tone frequency (2 - 4 kHz) / 80 dB
Network interface		1 port, 10/100 Mbps auto-detection (with built-in isolated power circuit) ²
USB		1 USB Slave Ver 2.0; 1 USB Host Ver 2.0
SD		N/A
Serial communication port	COM1	RS-232 (supports flow control) / RS-485 ²
	COM2	RS-422 / RS-485 ²
	COM3	N/A
Auxiliary function key		N/A
Calendar		Built-in
Cooling method		Natural cooling
Approvals		CE / UL (use shielding network cable and magnetic ring with the filter of 300 ohm / 100 MHz)
Panel waterproof level		IP65 / NEMA4 / UL TYPE 4X (indoor use only)
Operation voltage ²		DC +24V (-15% to +15%) (use an isolated power supply) Supplied by Class 2 or SELV circuit (isolated from MAINS by double insulation)
Leakage current		500 V _{AC} for 1 minute (between DC24V terminal and FG terminal)
Power consumption ³		7.14 W (Max) ³
Backup battery		3V lithium battery CR2032 x 1
Backup battery life		About 3 years or more at 25°C (77°F) (subject to operation temperature and condition)
Operation temperature		0°C to 50°C (32°F to 122°F)
Storage temperature		-20°C to +60°C (-4°F to 140°F)
Operating environment		10% to 90% RH [0 to 40°C (32°F to 104°F)], 10% to 55% RH [41 to 50°C (105.8°F to 122°F)], pollution degree: 2
Vibration resistance		Conforms to IEC61131-2: continuous vibration 5 Hz - 8.3 Hz with amplitude 3.5 mm; 8.3 Hz - 150 Hz with amplitude 1G
Shock resistance		Conforms to IEC60068-2-27: 11 ms, 15 G Peak, in X, Y, Z directions each for 6 times
Dimensions (W) x (H) x (D) mm		272.6 x 200.6 x 27.5
Mounting dimensions (W) x (H) mm		261.3 x 189.3
Weight		Approx. 1415 g

Note:

- The half-life of the backlight is defined as the maximum luminance being reduced by 50% when the maximum drive current is supplied to the HMI. The life of LED backlight shown here is estimated at the room temperature of 25°C (77°F) with ambient humidity.
- The withstand voltage of the isolated power circuit is 1500V peak for 1 minute.
- The HMI power consumption is the power consumed when the HMI is not connecting with other peripheral devices. To ensure normal operation of the HMI, the recommended capacity of the power supply is 1.5 to 2 times of the specified power consumption.
- Isolated power supply is recommended.
- For the programming software DOPSoft of DOP-100 series and its user manual, you can download them at <http://www.delta.com.tw/ia>.
- DOP-100 series can be used with other industrial automation equipment. Read through this sheet carefully and install the product according to the instructions to avoid danger.



High color • Wide screen •
User-friendly
No.18, Xinglong Rd., Taoyuan City
33068, Taiwan

DOP-110DS

Bilgi Dokümanı

(1) Önsöz

Bu ürünü satın aldığınız için teşekkür ederiz. Bu bilgi dokümanı DOP-100DV serisi için bilgiler sağlar. Ürünü kullanmadan önce, doğru şekilde kullanım sağlamak için lütfen dokümanı tamamen okuyunuz. Ayrıca daha sonra ihtiyaç duyulduğunda kullanabilmek için bu dokümanı iyi muhafaza ediniz. Bu dokümanı okumayı bitirdikten sonra lütfen aşağıda yazılı olan talimatları uygulayınız.

- Ürünün kurulumunu aşındırıcı, yanıcı gaz veya sıvılardan uzak, temiz ve kuru yerlere yapınız. Sadece iç mekânda kullanınız
- Tüm bağlantıların dokümanda belirtildiği gibi olduğuna emin olunuz.
- HMI toprak bağlantısının doğru olduğuna emin olunuz. Topraklama metodu uluslararası elektrik standardına uyumlu olmalıdır (NFPA 70: National Electrical Code, 2005 Ed).
- Ürün enerjili iken HMI'ı sökmezsiniz ve bağlantılara müdahale etmeyiniz.
- Çalışma sırasında güç kaynağına dokunmayınız. Aksi halde elektrik çarpması meydana gelebilir.
- HMI düşük pil uyarısı gösterirse ve pil değişimi gerekirse lütfen firmamız ile temasa geçiniz, kendiniz değiştirmeyiniz.
- DOP-100 serisi endüstriyel otomasyon ekipmanı olarak kullanılır. Lütfen bu dokümanı dikkatli okuyun ve tehlikeli durumları önlemek için ürünü belirtilen direktiflere uygun kurunuz.
- Temizleme metodu: Ürünü temizlemek için kuru bir bez kullanınız.
- Ürün 2000m altında bir rakımda kullanılmalıdır.
- Eğer ürün imalatçı tarafından belirtilmeyen bir şekilde kullanılıyorsa, ürün tarafından sağlanan koruma bozulabilir.
- Ürünle ilgili sorularınız için firmamız ile kontak kurabilirsiniz.

Ürünün kullanımı ile ilgili sorularınız için teknik servisimizle kontak kurabilirsiniz. Bu bilgi dokümanının içeriği herhangi bir bildirim gerek duyulmadan değiştirilebilir. Dokümanın son versiyonunu internetten indirebilirsiniz. <http://www.delta.com.tw/ia>.

(2) Haberleşme Pinleri

DOP-110DS COM1

COM Port	Pin	MOD 1		MOD 2		MOD 3	
		COM1	COM2	COM1	COM2	COM1	COM2
	1	-	-	D+	-	-	TXD+
	2	RXD	-	-	-	RXD	-
	3	TXD	-	-	-	TXD	-
	4	-	D+	-	D+	-	RXD+
	5	GND		GND		GND	
	6	-	-	D-	-	-	TXD-
	7	RTS	-	-	-	RTS	-
	8	CTS	-	-	-	CTS	-
	9	-	D-	-	D-	-	RXD-

Not: "-" olarak yazılan pinlere bağlantı yapılmaz.

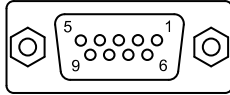

(3) Parça Açıklamaları

DOP-110DS (Ön Görünüm)

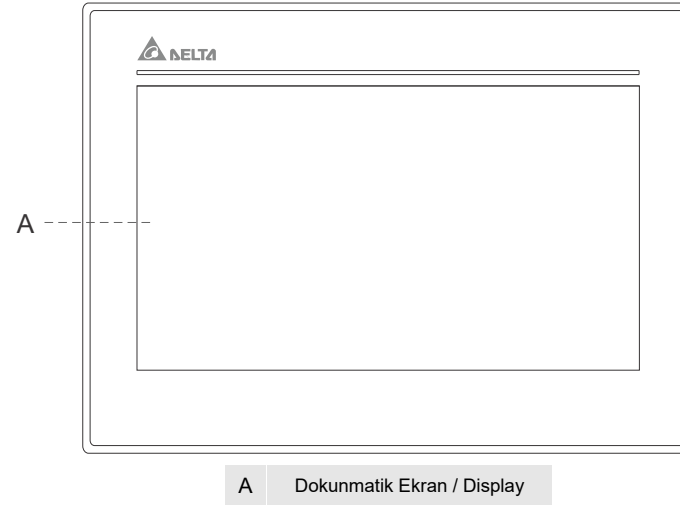

A Dokunmatik Ekran / Display

DOP-110DS (Arka Görünüm)

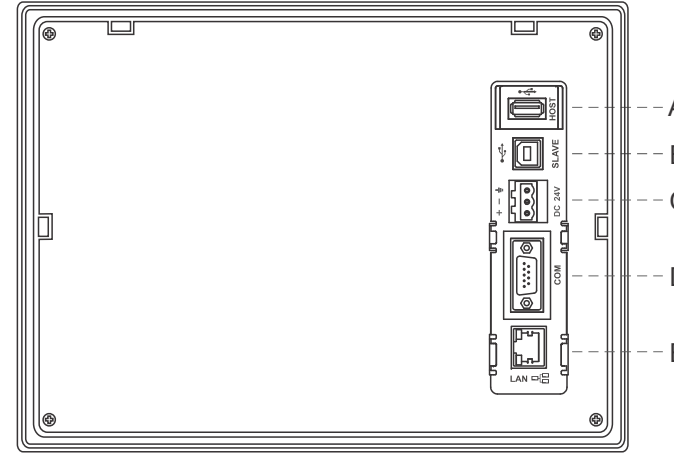

A	USB Host	B	USB Slave
C	Güç Giriş Soketi (24AWG kablo min.)	D	COM
E	Ethernet (LAN)	-	-

(4) Montaj Ölçüleri

DOP-110DS

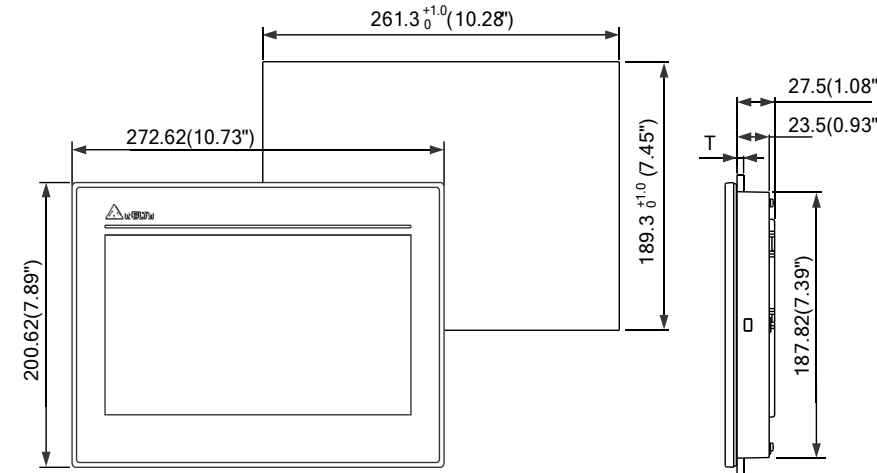

Note:
T=1.6 mm~6 mm(0.063"~0.24")

Çalışma Sıcaklığı: 0°C ~ 50°C (32°F ~ 122°F)

Depolama Sıcaklığı: -20°C ~ 60°C (-4°F ~ 140°F)

Birim: mm (inç)

(5) Montaj ve Kablolama

Önlemler:

- Yanlış kurulum arızalara sebep olabilir.
- HMI'ın iyi havalandırıldığından emin olmak için, HMI ile yakın objeler veya duvarlar arasında yeterli boşluk olduğundan emin olun.
- Bu ürün, 4X standartına uygun bir kasa / platform (sadece kapalı alanda kullanım) üzerinde kullanılmalıdır.
- Montaj için kullanılan panelin kalınlığı 5 mm'den az olmalıdır.

Montaj Adımları:

Adım 1:
HMI içine su geçirmez contanın takıldığına emin olunuz ve sonra pano boşluğuna yerleştiriniz.

Adım 2:
Montaj aparatlarını HMI'ın yuvalarına yerleştiriniz ve sonra panoya değene kadar vidaları sıkınız.

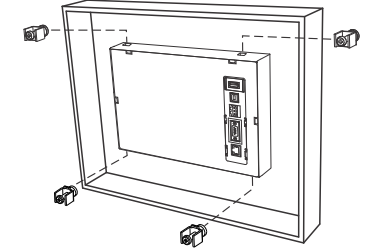
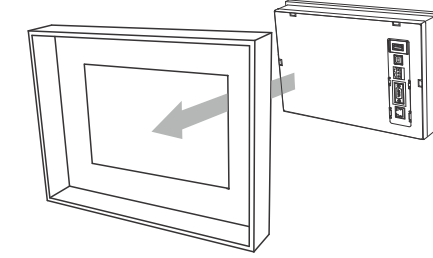

Adım 3:
Plastik kasaya zarar vermemek için vidayı 0.5 N-M'den fazla 0.7 N-M'den az tork ile sıkınız. DOP-110DS Tork: 6.17 lb-inç (0.7N-M)

Adım 4:
Isı dağılımı sağlanabilmesi için HMI arka paneli ile duvar, kurulum yüzeyi veya başka kontrol cihazı ile arasında en ez 60 mm boşluk bırakınız.

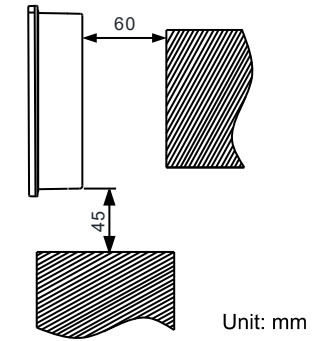
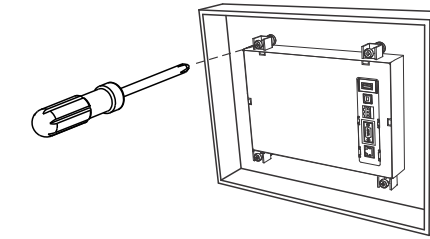

Unit: mm

Kablolama:

Tip	Kablo Ölçüsü (AWG)	Soyma Uzunluğu	Tork
Tek Damarlı	24 - 12	7 - 8 mm (0.28 - 0.31 inches)	5 kg-cm (4.3 lb-in)
Çok Damarlı	24 - 12	7 - 8 mm (0.28 - 0.31 inches)	5 kg-cm (4.3 lb-in)



Besleme konektörü bağlantısının aşağıdaki şekilde gösterildiği gibi yapıldığına emin olunuz. Kablo sıcaklık dayanım derecesi 75°C (167°F)'den yüksek olmalıdır.

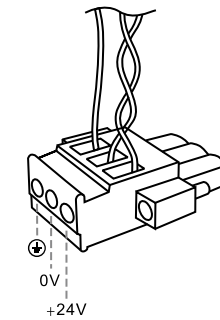

(6) Donanımsal Özellikler

Model		DOP-110DS
Ekan	Panel Tipi	7" TFT LCD (24 bits Renk)
	Çözünürlük	1024 x 600 Piksel
	Aydınlatma	LED Aydınlatma (Yarım ömürde 25°C'de 30,000 saatten az) ¹
	Ekran Ölçüsü	222.72 mm x 125.28 mm
	Parlaklık	350 cd / m ² (Tipik)
CPU		ARM Cortex-A8 (800 MHz)
Flash ROM		256 Mbytes
RAM		256 Mbytes
Dokunmatik		4 kablolu Rezistif Dokunmatik Ekran > 1,000,000 dokunma
Buzzer		Multi-tone frequency (2 - 4 kHz) / 80 dB
Ethernet Arabirimi		1 Port, 10 / 100 Mbps oto tanıma (Dâhili izolasyon devresi) ²
USB		1 USB Slave Ver 2.0; 1 USB Host Ver 2.0
SD		Yok
Seri Haberleşme Portu	COM1	RS-232 (Flow Kontrol Destekler) ²
	COM2	RS-232 (Flow Kontrol Destekler) / RS-485 ²
	COM3	Yok
Fonksiyon Tuşları		Yok
Takvim		Dâhili
Soğutma Metodu		Doğal Soğutma
Sertifikalar		CE / UL (Lütfen ekranlı Ethernet kablosu ve 300 ohm/100 MHz filtre ile manyetik halka kullanınız)
Su Geçirmezlik Seviyesi		IP65 / NEMA4 / UL TYPE 4X
Çalışma Voltajı ²		DC +24V (-15% ~ +15%) (Lütfen dâhili filtreli güç kaynağı kullanınız.) SELV ile beslenir. (Şebeke hattından çift yalıtım ile izole edilmiştir)
Kaçak Akım Dayanımı		1 dakika için 500 V _{AC} (DC24V terminal ve FG terminalleri arası)
Güç Tüketimi ²		7.14 W (Max) ³
Yedekleme Pili		3V lityum pil CR2032 × 1
Yedekleme Pil Ömrü		Normal koşullarda 25°C'de 3 yıl veya daha fazla.
Çalışma Sıcaklığı		0°C ~ 50°C (32°F ~ 122°F)
Depolama Sıcaklığı		-20°C ~ +60°C (-4°F ~ 140°F)
Çalışma Ortamı		10% ~ 90% RH [0°C - 40°C], 10% ~ 55% RH [41°C - 50°C]; Kirlenme Derecesi: 2
Titreşim Direnci		IEC61131-2 ile uyumlu; Sürekli: 5 Hz ~ 8.3 Hz 3.5 mm, 8.3 Hz ~ 150 Hz 1 G
Şok Direnci		IEC60068-2-27 ile uyumlu: 11 ms, 15 G Pik, X, Y, Z yönünde 6 kere
Ölçüleri (G) x (Y) x (D) mm		272.6 x 200.6 x 27.5
Kesim Ölçüleri (G) x (Y) mm		261.3 x 189.3
Ağırlık		Yaklaşık 1415 g

Not:

- Arka ışık yarı-ömrü maksimum besleme akımı HMI'ya uygulandığında orijinal parlaklığın %50 oranında azaltılmış olması olarak tanımlanır. Burada gösterilen LED aydınlatma ömrü 25°C normal sıcaklık ve nem koşullarında tahmini bir değerdir.
- İzoleli güç devresi dayanma voltajı 1 dakika için 1500 V pik.
- HMI güç tüketimi herhangi bir cihaza bağlı değil iken tükettiği güçtür. Normal çalışma için tavsiye edilen güç kaynağı tüketilen gücün 1.5 ~ 2 katıdır.
- İzoleli güç kaynağı kullanılması tavsiye edilir.
- DOP-100 serisi ürünlerin program editörü olan DOPSoft programı ve kullanıcı manuel'i web sayfamızdan indirilebilirsiniz. <http://www.delta.com.tw/ia>
- DOP-100 serisi endüstriyel otomasyon donanımı olarak kullanılabilir. Tehlikeleri önlemek için bu bilgi dokümanını dikkatlice okuyun ve belirtilen direktiflere göre kurulumu gerçekleştirin.

Delta Greentech Elektronik San. Ltd. Şti.

Şerifali Mahallesi, Hendem Caddesi, Kule Sokak, No:16,
A Blok Ümraniye / İstanbul, Türkiye
TEL: +90 216 499 99 10 Fax: + 90 216 499 80 70
Website: www.delta-turkey.com

Factory information:

Delta Electronics, Inc.
Taiwan China
31-1 Xingbang Road, 1688 Jiangding East Road,
Gulshan Industrial Zone, Wujiang Economic Development Zone
Taoyuan County 33370, Wujiang City, Jiang Su Province,
Taiwan People's Republic of China (Post code: 215200)
TEL: 886-3-362-6301 TEL: 86-512-6340-3008
FAX: 886-3-362-7267 FAX: 86-769-6340-7290



高彩・寬螢幕・友善人機介面
Delta Electronics, Inc,
No.18, Xinglong Rd., Taoyuan City
33068, Taiwan

DOP-110DS

安裝說明

(1) 一般注意事項

感謝您使用本產品。本人機介面安裝說明書提供 DOP-110DS 系列人機介面的相關資訊。在使用之前，請您仔細詳讀本說明書以確保能正確使用本產品。此外，請妥善將本說明書放置在明顯的地點以便隨時查閱。在您尚未讀完本說明書前，請務必遵守下列事項：

- 安裝的環境必須為沒有水氣、腐蝕性氣體及可燃性氣體之室內安裝環境 (indoor use only)。
- 接線時，請依接線圖說明施工。
- 接地工程必須確實實施，接地時須遵照國家現行相關電工法規之規定施行 (請參考 NFPA 70: National Electrical Code, 2005 Ed.)。
- 通電時，請勿拆解人機介面或更改配線。
- 通電運作時，請勿接觸電源處，以免觸電。
- 當程式顯示電量不足時須更換電池，請聯絡台達電子或當地經銷商，請勿自行更換。
- 此產品適用於工業自動化設備，請詳細閱讀此說明，並依指示安裝避免產生危險。
- 清潔方式：請以乾布擦拭清潔。
- 適用之海拔高度為 2000(6561.68 英尺)米以下。
- 若使用本設備時未遵循製造商所訂定之規格，將導致本設備所提供的保護功能受損。
- 維修請聯絡：台達電子工業股份有限公司，台灣桃園市興隆路 18 號，TEL: 03-3626301。

如果您在使用上仍有問題，請洽詢經銷商或者本公司客服中心。由於產品精益求精，當內容規格有所修正時，請洽詢代理商或至台達網站(<http://www.deltaww.com/ia>)下載最新版本。

(2) 通訊腳位定義

DOP-110DS COM1 定義

COM Port 示意圖	腳位	MODE1		MODE2		MODE3	
		COM1	COM2	COM1	COM2	COM1	COM2
		RS-232	RS-485	RS-485	RS-485	RS-232	RS-422
	1	-	-	D+	-	-	TXD+
	2	RXD	-	-	-	RXD	-
	3	TXD	-	-	-	TXD	-
	4	-	D+	-	D+	-	RXD+
	5	GND		GND		GND	
	6	-	-	D-	-	-	TXD-
	7	RTS	-	-	-	RTS	-
	8	CTS	-	-	-	CTS	-
	9	-	D-	-	D-	-	RXD-

註：“-”表示不需連接。

(3) 各部位說明

DOP-110DS (正面)

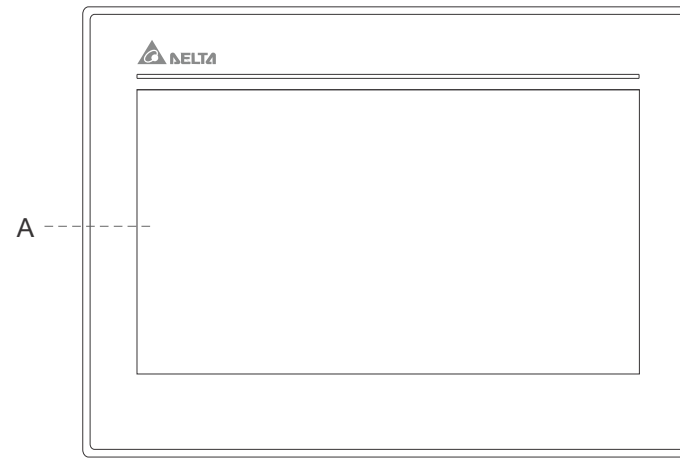

A 操作 / 顯示區域

DOP-110DS (背面)

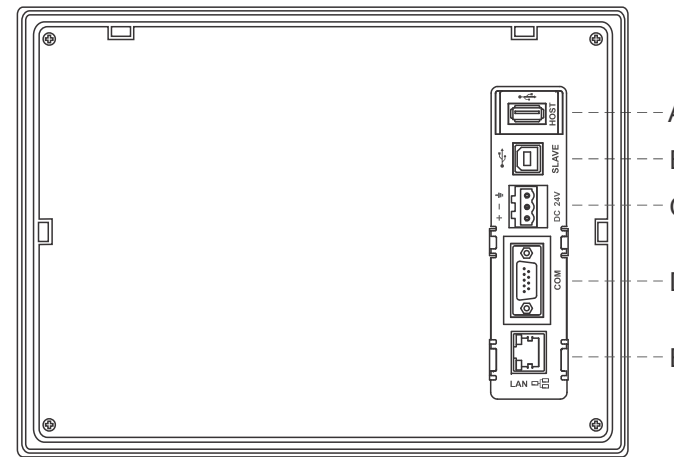

A	USB Host	B	USB Slave
C	電源輸入端子 (24 AWG wire min.)	D	COM
E	網路埠 (LAN)	-	-

(4) 開孔尺寸

DOP-110DS

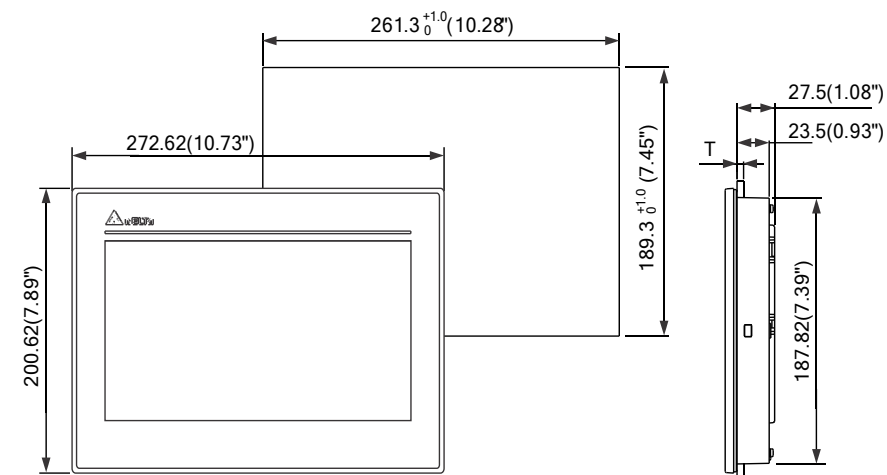

Note:
T=1.6 mm~6 mm(0.063"~0.24")

單位：mm (inch)

操作溫度為 0°C ~ 50°C；儲存溫度為 -20°C ~ +60°C

(5) 安裝方向與配線

注意事項：

- 安裝方向必須依圖面所示，否則會造成故障。
- 為了使冷卻循環效果良好，安裝人機介面時，其上下左右與相鄰的物品和擋板(牆)必須保持足夠的空間，否則會造成散熱不良。
- 使用於 Type 4X 室內用等級之外殼平面。
- 安裝面板最大板厚請勿超過 5 mm (0.2 inches)。
- 請用銅製導線。

安裝示意圖：

步驟一：

請確實套上防水墊圈，然後再安裝人機介面。

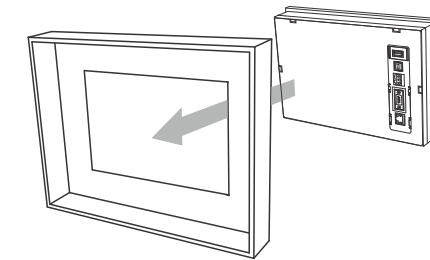

步驟二：

請確實將固定片螺絲組裝入內，然後下方鉤住前蓋螺絲頂住控制箱內側。

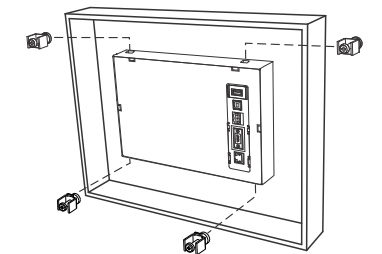

步驟三：

請以 0.5 N-M ~ 0.7 N-M 的扭力鎖緊螺絲，請勿超過此扭力，否則將損壞塑膠外殼。

DOP-110DS 扭力：6.17 lb-inch (0.7N-M)

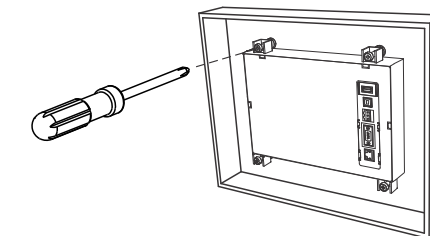

步驟四：

安裝時，請再人機後方及下方各預留 60 mm(2.36 inches)及 45 mm (1.77 inches) 的散熱空間。

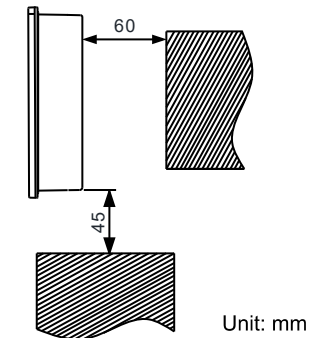

Unit: mm

配線：

種類	電源配線(AWG)	剝線長度	扭力
單芯線	24 ~ 12	7 ~ 8 mm (0.28 ~ 0.31 inches)	5 kg-cm (4.3 lb-in)
多芯線	24 ~ 12	7 ~ 8 mm (0.28 ~ 0.31 inches)	5 kg-cm (4.3 lb-in)



請參考下圖電源接頭端子進行配線，安裝與配線要求至少使用耐溫等級 75°C (167°F) 以上之線材：

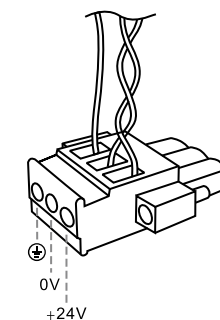

(6) 硬體規格

型號		DOP-110DS
顯示器	面板種類	10.1" TFT LCD (24 bits)
	解析度	1024 x 600 pixels
	背光燈	LED back light (常溫 25°C 下半衰期 > 3 萬小時) ¹
	顯示範圍	222.72 mm * 125.28 mm
	亮度	350 cd / m ² (Typ.)
中央處理器		ARM Cortex-A8 (800 MHz)
Flash ROM		256 Mbytes
RAM		256 Mbytes
觸控面板		四線電阻式 > 1,000,000 operated
蜂鳴器		Multi-tone frequency (2 k ~ 4 kHz) / 80 dB
網路介面		1 Port, 10/100 Mbps 自動偵測 (內建隔離電路) ²
USB		1 USB Slave Ver 2.0 ; 1 USB Host Ver 2.0
SD		N/A
串列通訊埠	COM1	RS-232 (支援流量控制) / RS485 ¹²
	COM2	RS-422 / RS-485 ¹²
	COM3	N/A
輔助鍵		N/A
萬年曆		內建
冷卻方式		自然冷卻
安規認證		CE / UL (請使用 shielding 網路線與使用磁環 300 ohm / 100 MHz 濾波)
面板防水等級		IP65 / NEMA4 / UL TYPE 4X (僅限用於室內環境)
工作電壓 ²		DC +24V (-15% ~ +15%) (請使用隔離式電源供應器) Supplied by Class 2 or SELV circuit (isolated from MAINS by double insulation)
絕緣耐力		DC24V 端子與 FG 端子間：AC500V, 1 分鐘
消耗功率 ³		7.14 W (Max) ¹³
記憶體備份電池		3V 鋰電池 CR2032 × 1
備份電池壽命		依使用環境溫度及使用條件而不同・常溫 25°C(77°F)下壽命約三年以上
操作溫度		0°C ~ 50°C (32°F ~ 122°F)
儲存溫度		-20°C ~ +60°C (-4°F ~ 140°F)
工作環境		10% ~ 90% RH [0 ~ 40°C (32°F ~ 104°F)] · 10% ~ 55% RH [41 ~ 50°C (105.8°F ~ 122°F)] · 污染等級 2
耐震動		IEC61131-2 規定連續震動 5 Hz ~ 8.3 Hz 3.5 mm, 8.3 Hz ~ 150 Hz 1G
耐衝擊		IEC60068-2-27 規定耐衝擊 11 ms, 15G Peak, X, Y, Z 方向各 6 次
尺寸 (W) x (H) x (D) mm		272.6 x 200.6 x 27.5
開孔尺寸 (W) x (H) mm		261.3 x 189.3
重量		約 1415 g

註：

- 背光模組半衰期的定義：最大驅動電流下，背光亮度衰退到最大亮度的一半時，即為半衰期。所標示之壽命時間為 25°C(77°F)常溫常濕工作環境下之預估值。
- 隔離電路耐受規格：可承受 1 分鐘 1500 V 高壓突波。
- 消耗功率為無外接週邊設備時，人機本體所消耗的功率。建議選用的電源供應器容量為標示消耗功率之 1.5 ~ 2 倍，以確保人機工作正常。
- 建議使用隔離式電源供應器。
- DOP-100 系列編輯軟體 DOPSoft 系列及其使用操作手冊，可由台達網站下載取得，網址為 <http://www.delta.com.tw/ia>。
- DOP-100 系列適用於工業自動化設備，請詳細閱讀此說明，並依指示安裝避免產生危險。



DOP-110DS

高彩·宽屏幕·友善人机接口
Delta Electronics, Inc,
No.18, Xinglong Rd., Taoyuan City
33068, Taiwan

安装说明

(1) 一般注意事项

感谢您使用本产品。本人机接口安装说明书提供 DOP-107DV 系列人机接口的相关信息。在使用之前，请您仔细阅读本说明书以确保能正确使用本产品。此外，请妥善将本说明书放置在明显的地点以便随时查阅。在您尚未读完本说明书前，请务必遵守下列事项：

- 安装的环境必须为没有水气、腐蚀性气体及可燃性气体之室内安装环境 (indoor use only)。
- 接线时，请依接线图说明施工。
- 接地工程必须确实实施，接地时须遵照国家现行相关电工法规之规定施行 (请参考 NFPA 70: National Electrical Code, 2005 Ed.)。
- 通电时，请勿拆解人机接口或更改配线。
- 通电运作时，请勿接触电源处，以免触电。
- 当程序显示电量不足时须更换电池，请联络台达电子或当地经销商，请勿自行更换。
- 此产品适用于工业自动化设备，请仔细阅读此说明，并依指示安装避免产生危险。
- 清洁方式：请以干布擦拭清洁。
- 适用之海拔高度为 2000(6561.68 英尺)米以下。
- 若使用本设备时未遵循制造商所订定之规格，将导致本设备所提供的保护功能受损。
- 维修请联络：台达电子工业股份有限公司，台湾桃园市兴隆路 18 号，TEL: 03-3626301。

如果您在使用上仍有问题，请洽询经销商或者本公司客服中心。由于产品精益求精，当内容规格有所修正时，请洽询代理商或至台达网站(<http://www.delta.com.tw/ia>)下载最新版本。

(2) 通讯脚位定义

DOP-110DS COM1 定义

COM Port 示意图	脚位	MODE1		MODE2		MODE3	
		COM1	COM2	COM1	COM2	COM1	COM2
		RS-232	RS-485	RS-485	RS-485	RS-232	RS-422
	1	-	-	D+	-	-	TXD+
	2	RXD	-	-	-	RXD	-
	3	TXD	-	-	-	TXD	-
	4	-	D+	-	D+	-	RXD+
	5	GND		GND		GND	
	6	-	-	D-	-	-	TXD-
	7	RTS	-	-	-	RTS	-
	8	CTS	-	-	-	CTS	-
	9	-	D-	-	D-	-	RXD-

注：“-”表示不需连接。

(3) 各部位说明

DOP-110DS (正面)

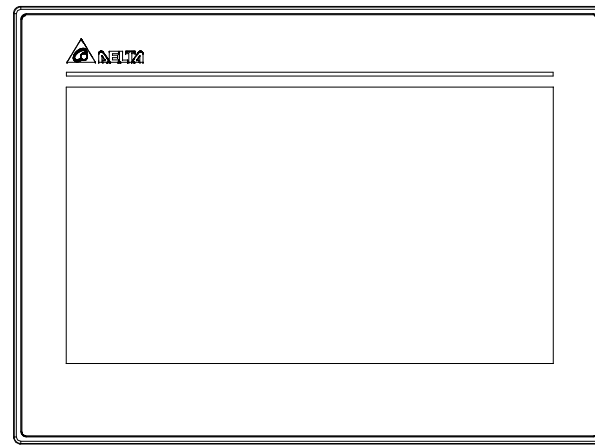

A 操作 / 显示区域

DOP-110DS (背面)

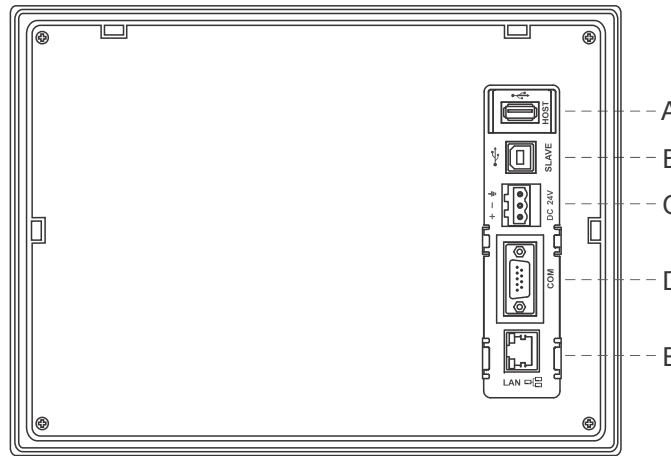

A	USB Host	B	USB Slave
C	电源输入端子 (24 AWG wire min.)	D	COM
E	网络端口 (LAN)	-	-

(4) 开孔尺寸

DOP-110DS

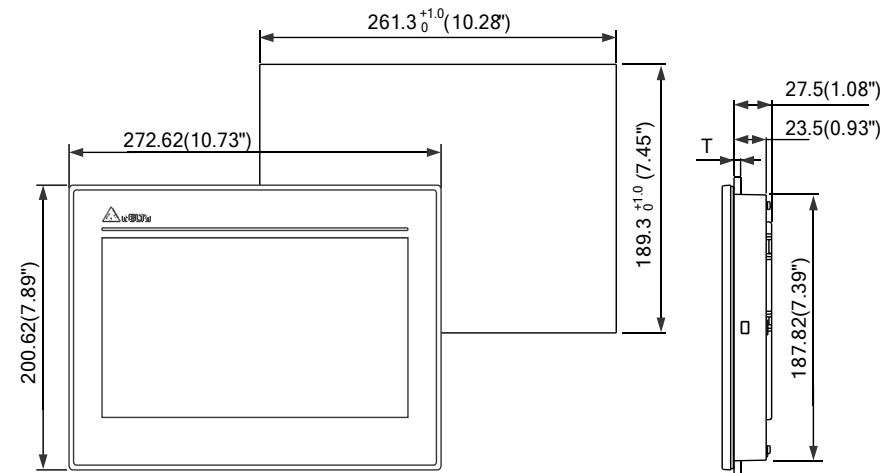

Note:
T=1.6 mm~6 mm(0.063"~0.24")

单位：mm (inch)

操作温度为 0°C ~ 50°C；储存温度为 -20°C ~ +60°C

(5) 安装方向与配线

注意事项：

- 安装方向必须依图面所示，否则会造成故障。
- 为了使冷却循环效果良好，安装人机接口时，其上下左右与相邻的物品和挡板(墙)必须保持足够的空间，否则会造成散热不良。
- 使用于 Type 4X 室内用等级之外壳平面。
- 安装面板最大板厚请勿超过 5 mm (0.2 inches)。
- 请用铜制导线。

安装示意图：

步骤一：

请确实套上防水垫圈，然后再安装人机接口。

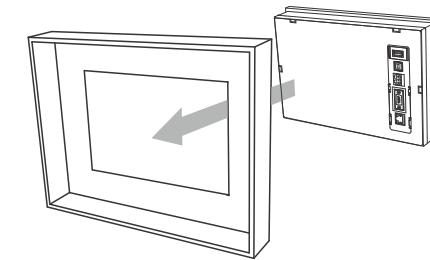

步骤二：

请确实将固定片螺丝组装入内，然后下方钩住前盖螺丝头顶住控制箱内侧。

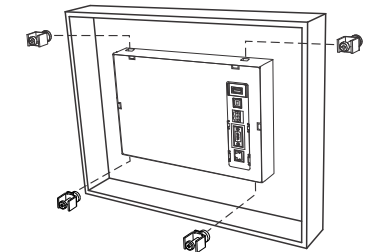

步骤三：

请以 0.5 N-M ~ 0.7 N-M 的扭力锁紧螺丝，请勿超过此扭力，否则将损坏塑料外壳。

DOP-110DS 扭力：6.17 lb-inch (0.7N-M)

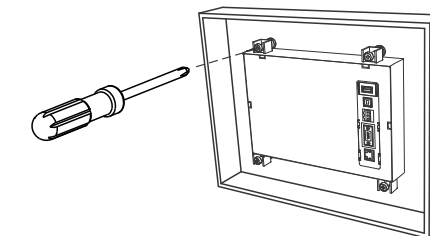

步骤四：

安装时，请再人机后方及下方各预留 60 mm(2.36 inches)及 45 mm (1.77 inches) 的散热空间。

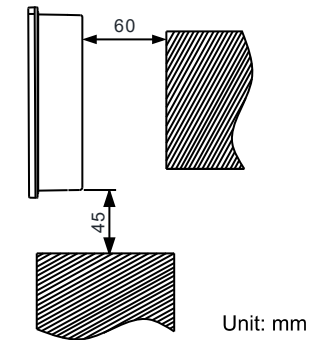

Unit: mm

配线：

种类	电源配线(AWG)	剥线长度	扭力
单芯线	24 ~ 12	7 ~ 8 mm (0.28 ~ 0.31 inches)	5 kg-cm (4.3 lb-in)
多芯线	24 ~ 12	7 ~ 8 mm (0.28 ~ 0.31 inches)	5 kg-cm (4.3 lb-in)



请参考下图电源接头端子进行配线，安装与配线要求至少使用耐温等级 75°C (167°F)以上之线材：

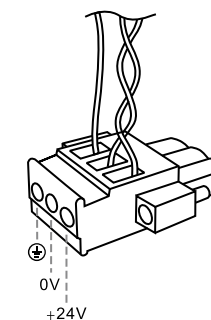

(6) 硬件规格

型号		DOP-110DS
显示器	面板种类	10.1" TFT LCD (24 bits)
	分辨率	1024 x 600 pixels
	背光灯	LED back light (常温 25°C 下半衰期 > 3 万小时) ¹
	显示范围	222.72 mm * 125.28 mm
	亮度	350 cd / m ² (Typ.)
中央处理器		ARM Cortex-A8 (800 MHz)
Flash ROM		256 Mbytes
RAM		256 Mbytes
触控面板		四线电阻式 > 1,000,000 operated
蜂鸣器		Multi-tone frequency (2 k ~ 4 kHz) / 80 dB
网络接口		1 Port, 10/100 Mbps 自动侦测 (内建隔离电路) ²
USB		1 USB Slave Ver 2.0 ; 1 USB Host Ver 2.0
SD		N/A
串行通讯端	COM1	RS-232 (支持流量控制) / RS485 ¹²
	COM2	RS-422 / RS-485 ¹²
	COM3	N/A
辅助键		N/A
万年历		内建
冷却方式		自然冷却
安规认证		CE / UL (请使用 shielding 网络线与使用磁环 300 ohm / 100 MHz 滤波)
面板防水等级		IP65 / NEMA4 / UL TYPE 4X (仅限用于室内环境)
工作电压 ²		DC +24V (-15% ~ +15%) (请使用隔离式电源供应器) Supplied by Class 2 or SELV circuit (isolated from MAINS by double insulation)
绝缘耐力		DC24V 端子与 FG 端子间 : AC500V, 1 分钟
消耗功率 ³		7.14 W (Max) ¹³
内存备份电池		3V 锂电池 CR2032 x 1
备份电池寿命		依使用环境温度及使用条件而不同 · 常温 25°C(77°F)下寿命约三年以上
操作温度		0°C ~ 50°C (32°F ~ 122°F)
储存温度		-20°C ~ +60°C (-4°F ~ 140°F)
工作环境		10% ~ 90% RH [0 ~ 40°C (32°F ~ 104°F)] · 10% ~ 55% RH [41 ~ 50°C (105.8°F ~ 122°F)] · 污染等级 2
耐震动		IEC61131-2 规定连续震动 5 Hz ~ 8.3 Hz 3.5 mm, 8.3 Hz ~ 150 Hz 1G
耐冲击		IEC60068-2-27 规定耐冲击 11 ms, 15G Peak, X, Y, Z 方向各 6 次
尺寸 (W) x (H) x (D) mm		272.6 x 200.6 x 27.5
开孔尺寸 (W) x (H) mm		261.3 x 189.3
重量		約 1415 g

注：

- 背光模块半衰期的定义：最大驱动电流下，背光亮度衰退到最大亮度的一半时，即为半衰期。所标示之寿命时间为 25°C(77°F)常温常湿工作环境下之预估值。
- 隔离电路耐受规格：可承受 1 分钟 1500 V 高压突波。
- 消耗功率为无外接外围设备时，人机本体所消耗的功率。建议选用的电源供应器容量为标示消耗功率之 1.5 ~ 2 倍，以确保人机工作正常。
- 建议使用隔离式电源供应器。
- DOP-100 系列编辑软件 DOPSoft 系列及其使用操作手册，可由台达网站下载取得，网址为 <http://www.delta.com.tw/ia>。
- DOP-100 系列适用于工业自动化设备，请仔细阅读此说明，并依指示安装避免产生危险。

部件名称 Part Name	有毒物质 -Hazardous Substances					
	铅(Pb)	汞(Hg)	镉(Cd)	六价铬 (Cr Vi)	多溴联苯 (PBB)	多溴二苯醚 (PBDE)
金属部件 Metal Part	X	O	O	O	O	O
塑料部件 Plastic Part	O	O	O	O	O	O
电子件 Electronic	X	O	O	O	O	O
触点 Contacts	O	O	X	O	O	O
线缆和线缆附件 Cable & Cabling accessories	X	O	O	O	O	O
电池 Bttery	O	O	O	O	O	O

本表格依据 SJ/T 11364 的规定编制。

O：表示该有害物质在该部件所有均质材料中的含量均在 GB/T 26572 规定的限量要求以下。

X：表示该有害物质至少在该部件的某一均质材料中的含量超出 GB/T 26572 规定的限量要求。



5014052100

This table is made according to SJ/T 11364.

O: Indicates that the concentration of hazardous substance in all of the homogeneous materials for this part is below the limit as stipulated in GB/T 26572.

X: Indicates that concentration of hazardous substance in at least one of the homogeneous materials used for this part is above the limit as stipulated in GB/T 26572.