



power contactor, AC-3e/AC-3, 16 A, 7.5 kW / 400 V, 3-pole, 24 V DC, with integrated varistor, auxiliary contacts: 1 NC, screw terminal, size: S00















product brand name	SIRIUS
product designation	Power contactor
product type designation	3RT2
General technical data	
size of contactor	S00
product extension	
• function module for communication	No
• auxiliary switch	Yes
power loss [W] for rated value of the current	
• at AC in hot operating state	3 W
• at AC in hot operating state per pole	1 W
• without load current share typical	4 W
type of calculation of power loss current-dependent	quadratic
insulation voltage	
• of main circuit with degree of pollution 3 rated value	690 V
• of auxiliary circuit with degree of pollution 3 rated value	690 V
surge voltage resistance	
• of main circuit rated value	6 kV
• of auxiliary circuit rated value	6 kV
maximum permissible voltage for protective separation between coil and main contacts according to EN 60947-1	400 V
shock resistance at rectangular impulse	
• at DC	7.3 g / 5 ms, 4.7 g / 10 ms
shock resistance with sine pulse	
• at DC	11,4 g / 5 ms, 7,3g / 10 ms
mechanical service life (operating cycles)	
• of contactor typical	30 000 000
• of the contactor with added electronically optimized auxiliary switch block typical	5 000 000
• of the contactor with added auxiliary switch block typical	10 000 000
reference code according to IEC 81346-2	Q
Substance Prohibitance (day/month/year)	10/01/2009
Net Weight	0.31 kg
Ambient conditions	
installation altitude at height above sea level maximum	2 000 m
ambient temperature	
• during operation	-25 ... +60 °C
• during storage	-55 ... +80 °C
relative humidity minimum	10 %
relative humidity at 55 °C according to IEC 60068-2-30	95 %

maximum	
Main circuit	
number of poles for main current circuit	3
number of NO contacts for main contacts	3
number of NC contacts for main contacts	0
operating voltage	
• at AC-3 rated value maximum	690 V
• at AC-3e rated value maximum	690 V
operational current	
• at AC-1 at 400 V at ambient temperature 40 °C rated value	22 A
• at AC-1	
— up to 690 V at ambient temperature 40 °C rated value	22 A
— up to 690 V at ambient temperature 60 °C rated value	20 A
• at AC-3	
— at 400 V rated value	16 A
— at 500 V rated value	12.4 A
— at 690 V rated value	8.9 A
• at AC-3e	
— at 400 V rated value	16 A
— at 500 V rated value	12.4 A
— at 690 V rated value	8.9 A
• at AC-4 at 400 V rated value	11.5 A
• at AC-5a up to 690 V rated value	19.4 A
• at AC-5b up to 400 V rated value	13.2 A
• at AC-6a	
— up to 230 V for current peak value n=20 rated value	9.6 A
— up to 400 V for current peak value n=20 rated value	9.6 A
— up to 500 V for current peak value n=20 rated value	9.6 A
— up to 690 V for current peak value n=20 rated value	8.9 A
• at AC-6a	
— up to 230 V for current peak value n=30 rated value	6.6 A
— up to 400 V for current peak value n=30 rated value	6.4 A
— up to 500 V for current peak value n=30 rated value	6.4 A
— up to 690 V for current peak value n=30 rated value	6.4 A
minimum cross-section in main circuit at maximum AC-1 rated value	4 mm ²
operational current for approx. 200000 operating cycles at AC-4	
• at 400 V rated value	5.5 A
• at 690 V rated value	4.4 A
operational current	
• at 1 current path at DC-1	
— at 24 V rated value	20 A
— at 60 V rated value	20 A
— at 110 V rated value	2.1 A
— at 220 V rated value	0.8 A
— at 440 V rated value	0.6 A
— at 600 V rated value	0.6 A
• with 2 current paths in series at DC-1	
— at 24 V rated value	20 A
— at 60 V rated value	20 A
— at 110 V rated value	12 A
— at 220 V rated value	1.6 A
— at 440 V rated value	0.8 A
— at 600 V rated value	0.7 A
• with 3 current paths in series at DC-1	
— at 24 V rated value	20 A

— at 60 V rated value	20 A
— at 110 V rated value	20 A
— at 220 V rated value	20 A
— at 440 V rated value	1.3 A
— at 600 V rated value	1 A
● at 1 current path at DC-3 at DC-5	
— at 24 V rated value	20 A
— at 60 V rated value	0.5 A
— at 110 V rated value	0.15 A
● with 2 current paths in series at DC-3 at DC-5	
— at 24 V rated value	20 A
— at 60 V rated value	5 A
— at 110 V rated value	0.35 A
● with 3 current paths in series at DC-3 at DC-5	
— at 24 V rated value	20 A
— at 60 V rated value	20 A
— at 110 V rated value	20 A
— at 220 V rated value	1.5 A
— at 440 V rated value	0.2 A
— at 600 V rated value	0.2 A
operating power	
● at AC-2 at 400 V rated value	7.5 kW
● at AC-3	
— at 230 V rated value	4 kW
— at 400 V rated value	7.5 kW
— at 500 V rated value	7.5 kW
— at 690 V rated value	7.5 kW
● at AC-3e	
— at 230 V rated value	4 kW
— at 400 V rated value	7.5 kW
— at 500 V rated value	7.5 kW
— at 690 V rated value	7.5 kW
operating power for approx. 200000 operating cycles at AC-4	
● at 400 V rated value	2.5 kW
● at 690 V rated value	3.5 kW
operating apparent power at AC-6a	
● up to 230 V for current peak value n=20 rated value	3.8 kVA
● up to 400 V for current peak value n=20 rated value	6.6 kVA
● up to 500 V for current peak value n=20 rated value	8.3 kVA
● up to 690 V for current peak value n=20 rated value	10.6 kVA
operating apparent power at AC-6a	
● up to 230 V for current peak value n=30 rated value	2.5 kVA
● up to 400 V for current peak value n=30 rated value	4.4 kVA
● up to 500 V for current peak value n=30 rated value	5.5 kVA
● up to 690 V for current peak value n=30 rated value	7.6 kVA
short-time withstand current in cold operating state up to 40 °C	
● limited to 1 s switching at zero current maximum	300 A; Use minimum cross-section acc. to AC-1 rated value
● limited to 5 s switching at zero current maximum	169 A; Use minimum cross-section acc. to AC-1 rated value
● limited to 10 s switching at zero current maximum	128 A; Use minimum cross-section acc. to AC-1 rated value
● limited to 30 s switching at zero current maximum	92 A; Use minimum cross-section acc. to AC-1 rated value
● limited to 60 s switching at zero current maximum	74 A; Use minimum cross-section acc. to AC-1 rated value
no-load switching frequency	
● at DC	10 000 1/h
operating frequency	
● at AC-1 maximum	1 000 1/h
● at AC-2 maximum	750 1/h
● at AC-3 maximum	750 1/h

<ul style="list-style-type: none"> ● at AC-3e <ul style="list-style-type: none"> — maximum ● at AC-4 maximum 	<p>750 1/h</p> <p>250 1/h</p>
Control circuit/ Control	
type of voltage of the control supply voltage	DC
control supply voltage at DC rated value	24 V
operating range factor control supply voltage rated value of magnet coil at DC	
<ul style="list-style-type: none"> ● initial value ● full-scale value 	<p>0.8</p> <p>1.1</p>
design of the surge suppressor	with varistor
closing power of magnet coil at DC	4 W
holding power of magnet coil at DC	4 W
closing delay	
<ul style="list-style-type: none"> ● at DC 	30 ... 100 ms
opening delay	
<ul style="list-style-type: none"> ● at DC 	7 ... 13 ms
arcing time	10 ... 15 ms
control version of the switch operating mechanism	Standard A1 - A2
Auxiliary circuit	
number of NC contacts for auxiliary contacts instantaneous contact	1
number of NO contacts for auxiliary contacts instantaneous contact	0
operational current at AC-12 maximum	10 A
operational current at AC-15	
<ul style="list-style-type: none"> ● at 230 V rated value ● at 400 V rated value ● at 500 V rated value ● at 690 V rated value 	<p>10 A</p> <p>3 A</p> <p>2 A</p> <p>1 A</p>
operational current at DC-12	
<ul style="list-style-type: none"> ● at 24 V rated value ● at 48 V rated value ● at 60 V rated value ● at 110 V rated value ● at 125 V rated value ● at 220 V rated value ● at 600 V rated value 	<p>10 A</p> <p>6 A</p> <p>6 A</p> <p>3 A</p> <p>2 A</p> <p>1 A</p> <p>0.15 A</p>
operational current at DC-13	
<ul style="list-style-type: none"> ● at 24 V rated value ● at 48 V rated value ● at 60 V rated value ● at 110 V rated value ● at 125 V rated value ● at 220 V rated value ● at 600 V rated value 	<p>10 A</p> <p>2 A</p> <p>2 A</p> <p>1 A</p> <p>0.9 A</p> <p>0.3 A</p> <p>0.1 A</p>
contact reliability of auxiliary contacts	1 faulty switching per 100 million (17 V, 1 mA)
UL/CSA ratings	
full-load current (FLA) for 3-phase AC motor	
<ul style="list-style-type: none"> ● at 480 V rated value ● at 600 V rated value 	<p>14 A</p> <p>11 A</p>
yielded mechanical performance [hp]	
<ul style="list-style-type: none"> ● for single-phase AC motor <ul style="list-style-type: none"> — at 110/120 V rated value — at 230 V rated value ● for 3-phase AC motor <ul style="list-style-type: none"> — at 200/208 V rated value — at 220/230 V rated value — at 460/480 V rated value — at 575/600 V rated value 	<p>1 hp</p> <p>2 hp</p> <p>3 hp</p> <p>5 hp</p> <p>10 hp</p> <p>10 hp</p>

contact rating of auxiliary contacts according to UL	A600 / Q600
Short-circuit protection	
design of the miniature circuit breaker for short-circuit protection of the auxiliary circuit up to 230 V	C characteristic: 10 A; 0.4 kA
design of the fuse link	
<ul style="list-style-type: none"> ● for short-circuit protection of the main circuit <ul style="list-style-type: none"> — with type of coordination 1 required — with type of coordination 2 required ● for short-circuit protection of the auxiliary switch required 	gG: 50 A (690 V, 100 kA), aM: 25 A (690 V, 100 kA), BS88: 50 A (415 V, 80 kA) gG: 25 A (690 V, 100 kA), aM: 20 A (690 V, 100 kA), BS88: 25 A (415 V, 80 kA) gG: 10 A (500 V, 1 kA)
Installation/ mounting/ dimensions	
mounting position	+/-180° rotation possible on vertical mounting surface; can be tilted forward and backward by +/- 22.5° on vertical mounting surface
fastening method side-by-side mounting	Yes
fastening method	screw and snap-on mounting onto 35 mm DIN rail according to DIN EN 60715
height	58 mm
width	45 mm
depth	73 mm
required spacing	
<ul style="list-style-type: none"> ● with side-by-side mounting <ul style="list-style-type: none"> — forwards — upwards — downwards — at the side ● for grounded parts <ul style="list-style-type: none"> — forwards — upwards — at the side — downwards ● for live parts <ul style="list-style-type: none"> — forwards — upwards — downwards — at the side 	10 mm 10 mm 10 mm 0 mm 10 mm 10 mm 6 mm 10 mm 10 mm 10 mm 10 mm 6 mm
Connections/ Terminals	
type of electrical connection	
<ul style="list-style-type: none"> ● for main current circuit ● for auxiliary and control circuit ● at contactor for auxiliary contacts ● of magnet coil 	screw-type terminals screw-type terminals Screw-type terminals Screw-type terminals
type of connectable conductor cross-sections	
<ul style="list-style-type: none"> ● for main contacts <ul style="list-style-type: none"> — solid — solid or stranded — finely stranded with core end processing ● for AWG cables for main contacts 	2x (0.5 ... 1.5 mm ²), 2x (0.75 ... 2.5 mm ²), 2x 4 mm ² 2x (0.5 ... 1.5 mm ²), 2x (0.75 ... 2.5 mm ²), 2x 4 mm ² 2x (0.5 ... 1.5 mm ²), 2x (0.75 ... 2.5 mm ²) 2x (20 ... 16), 2x (18 ... 14), 2x 12
connectable conductor cross-section for main contacts	
<ul style="list-style-type: none"> ● solid ● stranded ● finely stranded with core end processing 	0.5 ... 4 mm ² 0.5 ... 4 mm ² 0.5 ... 2.5 mm ²
connectable conductor cross-section for auxiliary contacts	
<ul style="list-style-type: none"> ● solid or stranded ● finely stranded with core end processing 	0.5 ... 4 mm ² 0.5 ... 2.5 mm ²
type of connectable conductor cross-sections	
<ul style="list-style-type: none"> ● for auxiliary contacts <ul style="list-style-type: none"> — solid or stranded — finely stranded with core end processing ● for AWG cables for auxiliary contacts 	2x (0.5 ... 1.5 mm ²), 2x (0.75 ... 2.5 mm ²), 2x 4 mm ² 2x (0.5 ... 1.5 mm ²), 2x (0.75 ... 2.5 mm ²) 2x (20 ... 16), 2x (18 ... 14), 2x 12
AWG number as coded connectable conductor cross section for main contacts	20 ... 12
AWG number as coded connectable conductor cross	20 ... 12

section for auxiliary contacts					
Safety related data					
product function					
<ul style="list-style-type: none"> • mirror contact according to IEC 60947-4-1 • positively driven operation according to IEC 60947-5-1 • suitable for safety function 	<p>Yes</p> <p>No</p> <p>Yes</p>				
suitability for use safety-related switching OFF	Yes				
service life maximum	20 a				
test wear-related service life necessary	Yes				
proportion of dangerous failures					
<ul style="list-style-type: none"> • with low demand rate according to SN 31920 • with high demand rate according to SN 31920 	<p>40 %</p> <p>73 %</p>				
B10 value with high demand rate according to SN 31920	1 000 000				
failure rate [FIT] with low demand rate according to SN 31920	100 FIT				
ISO 13849					
device type according to ISO 13849-1	3				
overdimensioning according to ISO 13849-2 necessary	Yes				
IEC 61508					
safety device type according to IEC 61508-2	Type A				
Electrical Safety					
protection class IP on the front according to IEC 60529	IP20				
touch protection on the front according to IEC 60529	finger-safe, for vertical contact from the front				
Approvals Certificates					
Environmental Product Declaration					
<ul style="list-style-type: none"> • global warming potential [CO2 eq] / during manufacturing • global warming potential [CO2 eq] / during operation • global warming potential [CO2 eq] / after end of life • global warming potential [CO2 eq] / total 	<p>1.42 kg</p> <p>152 kg</p> <p>-0.305 kg</p> <p>153 kg</p>				
Environment	General Product Approval				
Environmental Confirmations     					
General Product Approval	EMV	Test Certificates			
    		Special Test Certificate			
Test Certificates	Maritime application				
Type Test Certificates/Test Report     					
Maritime application	other	Railway			
	Miscellaneous	Confirmation	Miscellaneous		Special Test Certificate
Dangerous goods					

Further information

Information on the packaging

<https://support.industry.siemens.com/cs/ww/en/view/109813875>

Information for data generation and storage

<https://support.industry.siemens.com/cs/ww/en/view/109995012>

Information- and Downloadcenter (Catalogs, Brochures,...)

<https://www.siemens.com/ic10>

Industry Mall (Online ordering system)

<https://mall.industry.siemens.com/mall/en/en/Catalog/product?mlfb=3RT2018-1UB42>

Service&Support (Manuals, Certificates, Characteristics, FAQs,...)

<https://support.industry.siemens.com/cs/ww/en/ps/3RT2018-1UB42>

Image database (product images, 2D dimension drawings, 3D models, device circuit diagrams, EPLAN macros, ...)

https://www.automation.siemens.com/bilddb/cax_de.aspx?mlfb=3RT2018-1UB42&lang=en

Cax online generator

<https://support.automation.siemens.com/WW/CAXorder/default.aspx?lang=en&mlfb=3RT2018-1UB42>

Characteristic curves

[https://curves.simaris.siemens.com/curves/<mmp_prod_noCOMP="HAUPT"></mmp_prod_no>](https://curves.simaris.siemens.com/curves/<mmp_prod_noCOMP=)

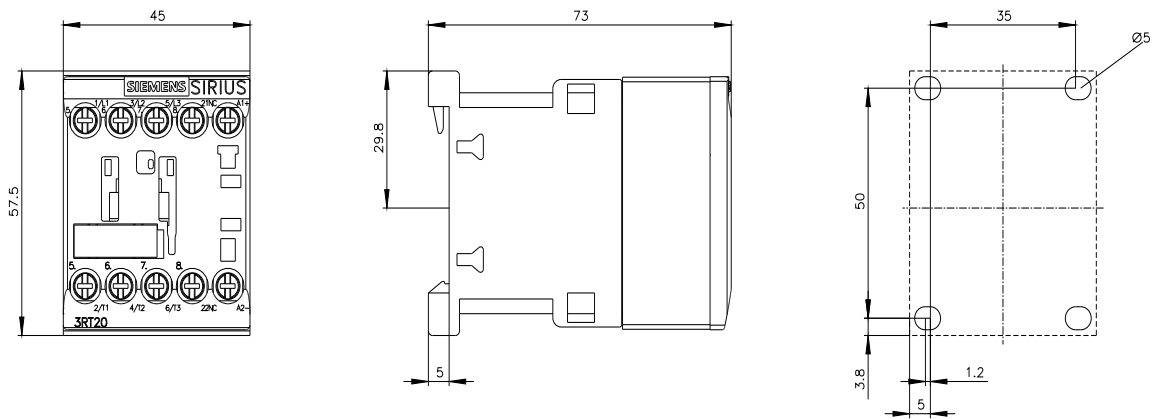

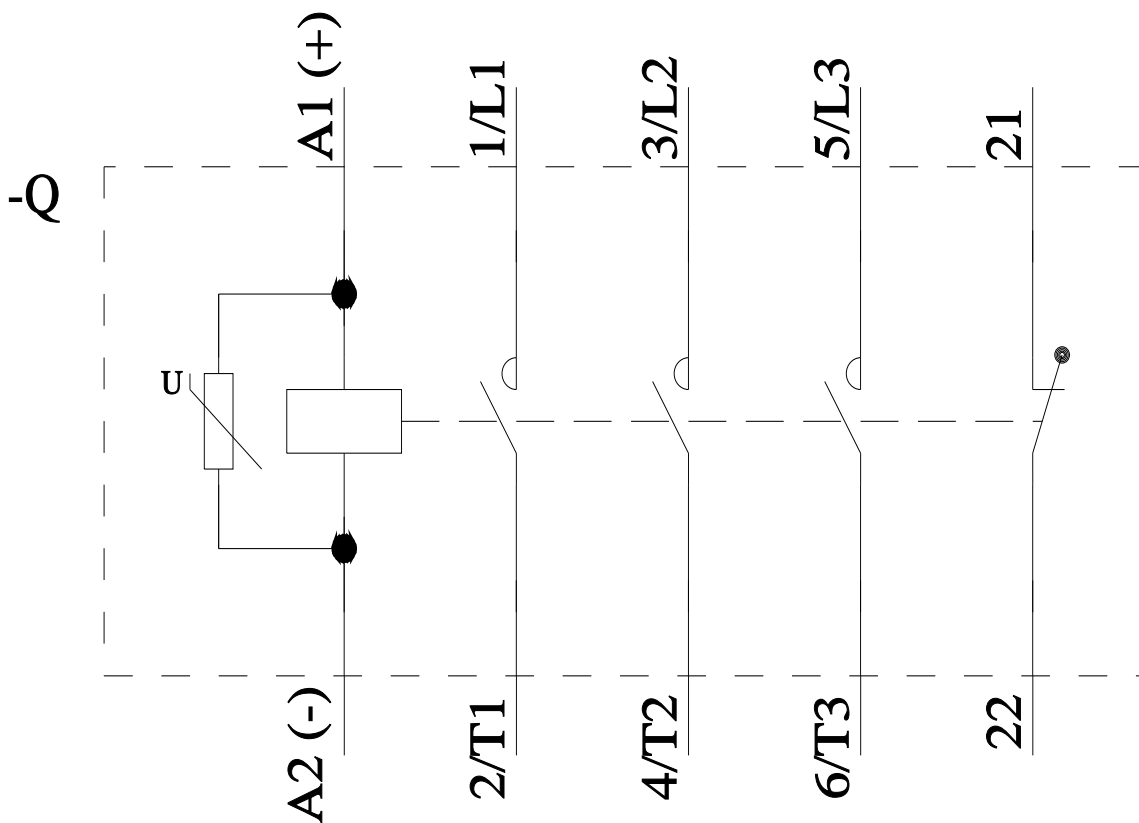

last modified:

4/4/2026