

Product data sheet

Specifications



SH3 OMC motor 70mm 1 st. IP65/54 keyed sh. DSL single turn str. conn.M23 brake

SH30701P1AF3000

⚠ Discontinued on: Oct 9, 2023

⚠ Discontinued

Product availability: Non-Stock - Not normally stocked in distribution facility

Main

Range Compatibility	PacDrive 3
Device short name	SH3
Product or Component Type	Servo motor

Complementary

Maximum mechanical speed	8000 rpm
[Us] rated supply voltage	115...480 V
Phase	Three phase
Continuous stall current	1.8 A
Continuous stall torque	11.06 lbf.in (1.25 N.m) 115...480 V three phase
Continuous power	690 W
Peak stall torque	31.0 lbf.in (3.5 N.m) 115...480 V three phase
Nominal output power	370 W 230 V single phase 690 W 400 V three phase 690 W 480 V three phase
Nominal torque	12.4 lbf.in (1.4 N.m) 230 V single phase 9.7 lbf.in (1.1 N.m) 400 V three phase 9.7 lbf.in (1.1 N.m) 480 V three phase
Nominal speed	3000 rpm 230 V single phase 6000 rpm 400 V three phase 7200 rpm 480 V three phase
Maximum current Irms	5.7 A
Shaft end	Parallel key
Shaft diameter	0.4 in (11 mm)
Shaft length	0.9 in (23 mm)
Key width	0.2 in (4 mm)
IP degree of protection	IP65 motor: conforming to IEC 60034-5 IP54 shaft bushing without shaft seal ring: conforming to IEC 60034-5
Encoder type	Absolute single turn Hiperface DSL
Speed feedback resolution	262144 points/turn
Holding brake	With
Holding torque	26.6 lbf.in (3 N.m)
Mounting Support	International standard flange

Price is "List Price" and may be subject to a trade discount – check with your local distributor or retailer for actual price.

Motor flange size	2.8 in (70 mm)
Electrical Connection	Straight connector
Torque constant	0.69 N.m/A 248 °F (120 °C)
Back emf constant	46 V/krpm 68 °F (20 °C)
Number of motor poles	3
Rotor inertia	0.322 kg.cm ²
Stator resistance	10.4 Ohm
Stator inductance	42.6 mH
Maximum radial force Fr	730 N 1000 rpm
Maximum axial force Fa	80 N
Brake pull-in power	7 W
Type of cooling	Natural convection
Length	7.09 in (180 mm)
Centring collar diameter	2.4 in (60 mm)
Centring collar depth	0.10 in (2.5 mm)
Number of mounting holes	4
Mounting holes diameter	0.2 in (5.5 mm)
Circle diameter of the mounting holes	3.2 in (82 mm)
Net Weight	5.5 lb(US) (2.5 kg)
Sizing reference	SH30701P
Network number of phases	3
Temperature copper hot	266 °F (130 °C)
Electrical connection	quicklock straight connector

Ordering and shipping details

Category	US1PC5218359
Discount Schedule	PC52
GTIN	3606481802910
Returnability	No

Packing Units

Unit Type of Package 1	PCE
Nbr. of units in pkg.	1
Package 1 Height	4.5 in (11.5 cm)
Package 1 Width	7.5 in (19.0 cm)
Package 1 Length	15.6 in (39.5 cm)
Package weight(Lbs)	6.4 lb(US) (2.9 kg)

Contractual warranty

Warranty (in months)	18
----------------------	----



Environmental Data

Schneider Electric aims to achieve Net Zero status by 2050 through supply chain partnerships, lower impact materials, and circularity via our ongoing “Use Better, Use Longer, Use Again” campaign to extend product lifetimes and recyclability.

[Environmental Data explained >](#)

[How we assess product sustainability >](#)

Use Better



Materials and Substances

[EU RoHS Directive](#)

Pro-active compliance (Product out of EU RoHS legal scope)

California proposition 65

WARNING: This product can expose you to chemicals including: Lead and lead compounds, which is known to the State of California to cause cancer and birth defects or other reproductive harm. For more information go to www.P65Warnings.ca.gov

PVC free

Yes

Use Longer



Lifetime extension

Repair

No

Use Again



Repack and remanufacture

Circularity Profile

No need of specific recycling operations

Dimensions Drawings

Dimensions

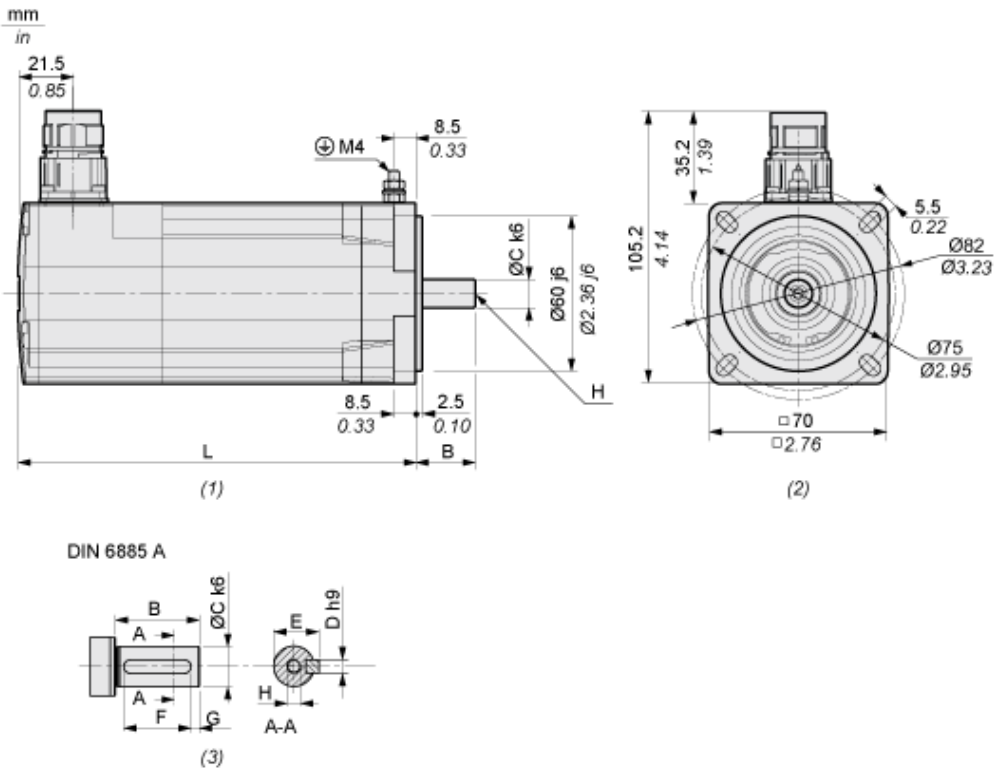

- (1) : Side view
- (2) : Mounting
- (3) : Feather key

Characteristic	Unit	Value
L	Length with holding brake	mm (in) 180 (7.09)
B	Shaft length	mm (in) 23 (0.91)
C	Shaft diameter	mm (in) 11 (0.43)
D	Width of parallel key	mm (in) 4 (0.16)
E	Shaft width with parallel key	mm (in) 12.5 (0.49)
F	Length of parallel key	mm (in) 18 (0.71)
G	Distance parallel key to shaft end	mm (in) 2.5 (0.1)
H	Female thread of shaft	DIN 332-D M4
	Parallel key	DIN 6885-A4x4x18