

XCMD41F2L5EX

Limit switch, Limit switches XC Standard, XCMD, roller plunger, 2NC + 2 NO, ATEX/IECEX



Main

Range of Product	Telemecanique Limit switches XC Standard
Series name	Standard format
Product or Component Type	Limit switch
Device short name	XCMD
Sensor design	Miniature
Body type	Fixed
Head type	M12 plunger head
Material	Metal
Fixing Mode	By the head
Movement of operating head	Linear
Type of operator	Spring return roller plunger steel
Switch actuation	By 30° cam
Type of approach	Lateral approach, 2 directions
Electrical connection	Fixed cable
Number of poles	4
Contacts type and composition	2 x (1 NC + 1 NO)
Contacts insulation form	Zb
Contact operation	Snap action
Number of steps	1
Positive opening	With
Minimum force for tripping	7 N
Maximum actuation speed	0.33 ft/s (0.1 m/s)
IP degree of protection	IP66 conforming to IEC 60529 IP67 conforming to IEC 60529

Complementary

Body Material	Zamak
Head material	Zamak
Cable length	16.40 ft (5 m)
Cable composition	9 x 0.34 mm ²
Wire insulation material	PvR
Positive opening minimum force	35 N
Minimum actuation speed	0.01 m/min
Contact code designation	R300, DC-13 (Ue = 250 V), Ie = 0.1 A EN 60947-5-1 R300, DC-13 (Ue = 250 V), Ie = 0.1 A IEC 60947-5-1 appendix A C300, AC-15 (Ue = 240 V), Ie = 0.75 A EN 60947-5-1 C300, AC-15 (Ue = 240 V), Ie = 0.75 A IEC 60947-5-1 appendix A
[Ithe] conventional enclosed thermal current	3 A AC
[Ui] rated insulation voltage	300 VUL 508 400 V 3)IEC 60947-1 300 VCSA C22.2 No 14
Maximum resistance across terminals	25 MOhm IEC 60255-7 category 3
[Uimp] rated impulse withstand voltage	4 KV IEC 60664 4 kV IEC 60947-1

Short-circuit protection	6 A cartridge fuse gG
Electrical durability	5000000 Cycles, DC-13, inductive, 24 V, 3 W 3600 cyc/mn 0.5, DC IEC 60947-5-1 appendix C 5000000 Cycles, DC-13, inductive, 48 V, 2 W 3600 cyc/mn 0.5, DC IEC 60947-5-1 appendix C 5000000 cycles, DC-13, inductive, 120 V, 1 W 3600 cyc/mn 0.5, DC IEC 60947-5-1 appendix C
Mechanical durability	10000000 cycles
Marking	II2 D-Ex tb IIIC T85°C Db IP66/67
Width	1.18 in (30 mm)
Height	1.97 in (50 mm)
Depth	0.63 in (16 mm)

Environment

Shock resistance	25 gn 18 ms IEC 60068-2-27
Vibration resistance	5 gn 10...500 Hz)IEC 60068-2-6
Electrical shock protection class	Class I IEC 61140 Class I NF C 20-030
Ambient Air Temperature for Operation	-4...140 °F (-20...60 °C)
Protective treatment	TC
Dust zone	Zone 21 - 22
Product Certifications	INERIS 04ATEX0014X IEC-Ex INE 17.0020X
Standards	EN/IEC 60079-31 EN/IEC 60079-0
Directives	2014/34/EU - ATEX directive

Ordering and shipping details

Category	22413-LIMIT SWITCH, IEC, MINIATURE
Discount Schedule	T
GTIN	3389118027558
Nbr. of units in pkg.	1
Package weight(Lbs)	18.10 oz (513.0 g)
Returnability	No
Country of origin	FR

Packing Units

Unit Type of Package 1	PCE
Package 1 Height	5.91 in (15.0 cm)
Package 1 width	5.51 in (14.0 cm)
Package 1 Length	1.97 in (5.0 cm)
Unit Type of Package 2	BAG
Number of Units in Package 2	1
Package 2 Weight	18.10 oz (513.0 g)
Package 2 Height	9.06 in (23.0 cm)
Package 2 width	1.97 in (5.0 cm)
Package 2 Length	7.48 in (19.0 cm)

Offer Sustainability

Sustainable offer status	Green Premium product
California proposition 65	WARNING: This product can expose you to chemicals including: Diisononyl phthalate (DINP), which is known to the State of California to cause cancer, and Di-isodecyl phthalate (DIDP), which is known to the State of California to cause birth defects or other reproductive harm. For more information go to www.P65Warnings.ca.gov
REACH Regulation	REACH Declaration
EU RoHS Directive	Pro-active compliance (Product out of EU RoHS legal scope) EU RoHS Declaration
Mercury free	Yes
RoHS exemption information	Yes
Environmental Disclosure	Product Environmental Profile
Circularity Profile	End Of Life Information

Contractual warranty

Warranty	18 months
----------	-----------

Dimensions

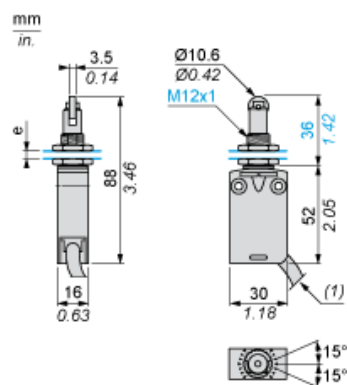

- (1) External diameter of cable 7.5 mm.
e : 8 mm max, panel cut-out $\text{Ø} 12.5$ mm.

Mounting

Sweep of Connecting Cable

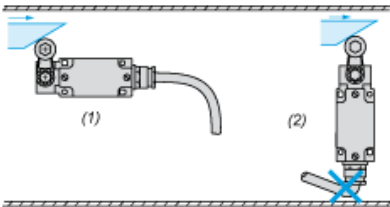

- (1) Recommended
- (2) To be avoided

Panel Mounting

Mounting and Fixing Limit Switches by the Head

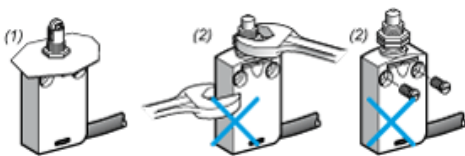

- (1) Recommended
- (2) Forbidden

Setting-up

Plunger or Multi-directional Heads

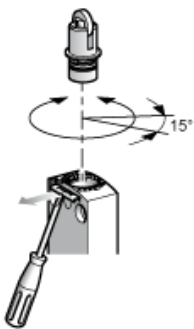

Wiring Diagram

4-pole NC + NC + NO + NO Snap Action

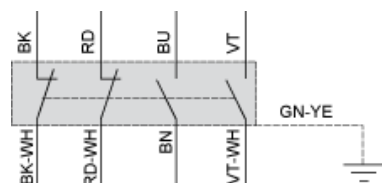

- (BK) Black
- (BK- Black White
WH)
- (RD) Red
- (RD- Red White
WH)
- (BU) Blue
- (BN) Brown
- (VT) Violet White
- (VT- Violet White
WH)
- (GN- Green Yellow
YE)

Characteristics of Actuation

Switch Actuation by 30° Cam

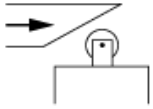

Functional Diagram

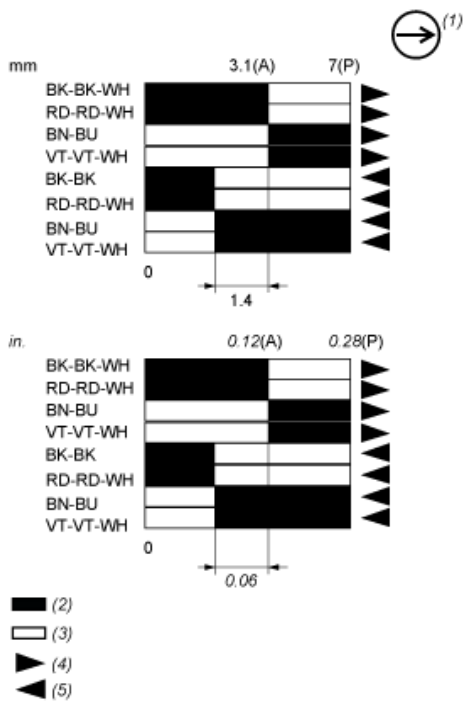

- (P) Positive opening point
- (A) Cam displacement
- (1) NC contact with positive opening operation
- (2) Closed
- (3) Open
- (4) Tripping
- (5) Resetting
- (BK) Black
- (BK- Black White
- WH)
- (RD) Red
- (RD- Red White
- WH)
- (BN) Brown
- (BU) Blue
- (VT) Violet
- (VT Violet White
- WH)