



power contactor, AC-3e/AC-3, 41 A, 18.5 kW / 400 V, 3-pole, 83-155 V AC/DC, 50/60 Hz, with integrated varistor, auxiliary contacts: 1 NO + 1 NC, main circuit: screw terminal, control and auxiliary circuit: spring-loaded terminal, size: S2,

<b>product brand name</b>	SIRIUS
<b>product designation</b>	Power contactor
<b>product type designation</b>	3RT2
<b>General technical data</b>	
<b>size of contactor</b>	S2
<b>product extension</b>	
• function module for communication	No
• auxiliary switch	Yes
<b>power loss [W] for rated value of the current</b>	
• at AC in hot operating state	6.6 W
• at AC in hot operating state per pole	2.2 W
• without load current share typical	1 W
<b>type of calculation of power loss current-dependent</b>	quadratic
<b>insulation voltage</b>	
• of main circuit with degree of pollution 3 rated value	690 V
• of auxiliary circuit with degree of pollution 3 rated value	690 V
<b>surge voltage resistance</b>	
• of main circuit rated value	6 kV
• of auxiliary circuit rated value	6 kV
maximum permissible voltage for protective separation between coil and main contacts according to EN 60947-1	400 V
<b>shock resistance at rectangular impulse</b>	
• at AC	7.7 g / 5 ms, 4.5 g / 10 ms
• at DC	7.7 g / 5 ms, 4.5 g / 10 ms
<b>shock resistance with sine pulse</b>	
• at AC	12 g / 5 ms, 7 g / 10 ms
• at DC	12 g / 5 ms, 7 g / 10 ms
<b>mechanical service life (operating cycles)</b>	
• of contactor typical	10 000 000
• of the contactor with added electronically optimized auxiliary switch block typical	5 000 000
• of the contactor with added auxiliary switch block typical	10 000 000
<b>reference code according to IEC 81346-2</b>	Q
<b>Substance Prohibitance (day/month/year)</b>	10/01/2014
<b>SVHC substance name</b>	Lead CAS-No. 7439-92-1 Lead monoxide (lead oxide) CAS-No. 1317-36-8 2-methyl-1-(4-methylthiophenyl)-2-morpholinopropan-1-one CAS-No. 71868-10-5 Melamine CAS-No. 108-78-1
<b>Net Weight</b>	1.112 kg
<b>Ambient conditions</b>	

installation altitude at height above sea level maximum	2 000 m
<b>ambient temperature</b>	
• during operation	-25 ... +60 °C
• during storage	-55 ... +80 °C
<b>relative humidity minimum</b>	10 %
<b>relative humidity at 55 °C according to IEC 60068-2-30 maximum</b>	95 %
<b>Main circuit</b>	
<b>number of poles for main current circuit</b>	3
<b>number of NO contacts for main contacts</b>	3
<b>number of NC contacts for main contacts</b>	0
<b>operating voltage</b>	
• at AC-3 rated value maximum	690 V
• at AC-3e rated value maximum	690 V
<b>operational current</b>	
• at AC-1 at 400 V at ambient temperature 40 °C rated value	60 A
• at AC-1	
— up to 690 V at ambient temperature 40 °C rated value	60 A
— up to 690 V at ambient temperature 60 °C rated value	55 A
• at AC-3	
— at 400 V rated value	41 A
— at 500 V rated value	41 A
— at 690 V rated value	24 A
• at AC-3e	
— at 400 V rated value	41 A
— at 500 V rated value	41 A
— at 690 V rated value	24 A
• at AC-4 at 400 V rated value	35 A
• at AC-5a up to 690 V rated value	52.8 A
• at AC-5b up to 400 V rated value	33.2 A
• at AC-6a	
— up to 230 V for current peak value n=20 rated value	36.5 A
— up to 400 V for current peak value n=20 rated value	36.5 A
— up to 500 V for current peak value n=20 rated value	36.5 A
— up to 690 V for current peak value n=20 rated value	24 A
• at AC-6a	
— up to 230 V for current peak value n=30 rated value	24.2 A
— up to 400 V for current peak value n=30 rated value	24.2 A
— up to 500 V for current peak value n=30 rated value	24.2 A
— up to 690 V for current peak value n=30 rated value	24 A
minimum cross-section in main circuit at maximum AC-1 rated value	16 mm <sup>2</sup>
<b>operational current for approx. 200000 operating cycles at AC-4</b>	
• at 400 V rated value	22 A
• at 690 V rated value	18.5 A
<b>operational current</b>	
• <b>at 1 current path at DC-1</b>	
— at 24 V rated value	55 A
— at 60 V rated value	23 A
— at 110 V rated value	4.5 A
— at 220 V rated value	1 A
— at 440 V rated value	0.4 A
— at 600 V rated value	0.25 A
• <b>with 2 current paths in series at DC-1</b>	
— at 24 V rated value	55 A
— at 60 V rated value	45 A
— at 110 V rated value	45 A

— at 220 V rated value	5 A
— at 440 V rated value	1 A
— at 600 V rated value	0.8 A
<b>• with 3 current paths in series at DC-1</b>	
— at 24 V rated value	55 A
— at 60 V rated value	55 A
— at 110 V rated value	55 A
— at 220 V rated value	45 A
— at 440 V rated value	2.9 A
— at 600 V rated value	1.4 A
<b>• at 1 current path at DC-3 at DC-5</b>	
— at 24 V rated value	35 A
— at 60 V rated value	6 A
— at 220 V rated value	1 A
— at 440 V rated value	0.1 A
— at 600 V rated value	0.06 A
<b>• with 2 current paths in series at DC-3 at DC-5</b>	
— at 24 V rated value	55 A
— at 60 V rated value	45 A
— at 110 V rated value	25 A
— at 220 V rated value	5 A
— at 440 V rated value	0.27 A
— at 600 V rated value	0.16 A
<b>• with 3 current paths in series at DC-3 at DC-5</b>	
— at 24 V rated value	55 A
— at 60 V rated value	55 A
— at 110 V rated value	55 A
— at 220 V rated value	25 A
— at 440 V rated value	0.6 A
— at 600 V rated value	0.35 A
<b>operating power</b>	
• at AC-2 at 400 V rated value	18.5 kW
• at AC-3	
— at 230 V rated value	11 kW
— at 400 V rated value	18.5 kW
— at 500 V rated value	22 kW
— at 690 V rated value	22 kW
• at AC-3e	
— at 230 V rated value	11 kW
— at 400 V rated value	18.5 kW
— at 500 V rated value	22 kW
— at 690 V rated value	22 kW
<b>operating power for approx. 200000 operating cycles at AC-4</b>	
• at 400 V rated value	11.6 kW
• at 690 V rated value	16.8 kW
<b>operating apparent power at AC-6a</b>	
• up to 230 V for current peak value n=20 rated value	14.5 kVA
• up to 400 V for current peak value n=20 rated value	25.2 kVA
• up to 500 V for current peak value n=20 rated value	31.6 kVA
• up to 690 V for current peak value n=20 rated value	28.6 kVA
<b>operating apparent power at AC-6a</b>	
• up to 230 V for current peak value n=30 rated value	9.6 kVA
• up to 400 V for current peak value n=30 rated value	16.8 kVA
• up to 500 V for current peak value n=30 rated value	21 kVA
• up to 690 V for current peak value n=30 rated value	28.6 kVA
<b>short-time withstand current in cold operating state up to 40 °C</b>	
• limited to 1 s switching at zero current maximum	843 A; Use minimum cross-section acc. to AC-1 rated value

<ul style="list-style-type: none"> <li>• limited to 5 s switching at zero current maximum</li> <li>• limited to 10 s switching at zero current maximum</li> <li>• limited to 30 s switching at zero current maximum</li> <li>• limited to 60 s switching at zero current maximum</li> </ul>	596 A; Use minimum cross-section acc. to AC-1 rated value
	400 A; Use minimum cross-section acc. to AC-1 rated value
	241 A; Use minimum cross-section acc. to AC-1 rated value
	196 A; Use minimum cross-section acc. to AC-1 rated value
<b>no-load switching frequency</b>	
<ul style="list-style-type: none"> <li>• at AC</li> <li>• at DC</li> </ul>	1 500 1/h
	1 500 1/h
<b>operating frequency</b>	
<ul style="list-style-type: none"> <li>• at AC-1 maximum</li> <li>• at AC-2 maximum</li> <li>• at AC-3 maximum</li> <li>• at AC-3e <ul style="list-style-type: none"> <li>— maximum</li> </ul> </li> <li>• at AC-4 maximum</li> </ul>	1 200 1/h
	750 1/h
	1 000 1/h
	1 000 1/h
	300 1/h
<b>Control circuit/ Control</b>	
<b>type of voltage of the control supply voltage</b>	AC/DC
<b>control supply voltage at AC</b>	
<ul style="list-style-type: none"> <li>• at 50 Hz rated value</li> <li>• at 60 Hz rated value</li> </ul>	83 ... 155 V
	83 ... 155 V
<b>control supply voltage at DC rated value</b>	83 ... 155 V
<b>operating range factor control supply voltage rated value of magnet coil at DC</b>	
<ul style="list-style-type: none"> <li>• initial value</li> <li>• full-scale value</li> </ul>	0.8
	1.1
<b>operating range factor control supply voltage rated value of magnet coil at AC</b>	
<ul style="list-style-type: none"> <li>• at 50 Hz</li> <li>• at 60 Hz</li> </ul>	0.8 ... 1.1
	0.8 ... 1.1
<b>design of the surge suppressor</b>	with varistor
<b>inrush current peak</b>	1.5 A
<b>duration of inrush current peak</b>	50 µs
<b>pickup current mean value</b>	0.45 A
<b>pickup current peak</b>	0.8 A
<b>duration of pickup current</b>	230 ms
<b>holding current mean value</b>	12 mA
<b>apparent pick-up power of magnet coil at AC</b>	
<ul style="list-style-type: none"> <li>• at 50 Hz</li> <li>• at 60 Hz</li> </ul>	40 VA
	40 VA
<b>apparent holding power</b>	
<ul style="list-style-type: none"> <li>• at minimum rated control supply voltage at DC</li> <li>• at maximum rated control supply voltage at DC</li> </ul>	2 VA
	2 VA
<b>apparent holding power</b>	
<ul style="list-style-type: none"> <li>• at minimum rated control supply voltage at AC <ul style="list-style-type: none"> <li>— at 50 Hz</li> <li>— at 60 Hz</li> </ul> </li> <li>• at maximum rated control supply voltage at AC <ul style="list-style-type: none"> <li>— at 50 Hz</li> <li>— at 60 Hz</li> </ul> </li> </ul>	2 VA
	2 VA
	2 VA
	2 VA
	2 VA
<b>apparent holding power of magnet coil at AC</b>	
<ul style="list-style-type: none"> <li>• at 50 Hz</li> <li>• at 60 Hz</li> </ul>	2 VA
	2 VA
<b>inductive power factor with the holding power of the coil</b>	
<ul style="list-style-type: none"> <li>• at 50 Hz</li> <li>• at 60 Hz</li> </ul>	0.95
	0.95
<b>closing power of magnet coil at DC</b>	23 W
<b>holding power of magnet coil at DC</b>	1 W
<b>closing delay</b>	
<ul style="list-style-type: none"> <li>• at AC</li> <li>• at DC</li> </ul>	35 ... 110 ms
	35 ... 110 ms

<b>opening delay</b>	
• at AC	30 ... 55 ms
• at DC	30 ... 55 ms
<b>arcing time</b>	10 ... 20 ms
<b>control version of the switch operating mechanism</b>	Standard A1 - A2
<b>Auxiliary circuit</b>	
number of NC contacts for auxiliary contacts instantaneous contact	1
number of NO contacts for auxiliary contacts instantaneous contact	1
operational current at AC-12 maximum	10 A
<b>operational current at AC-15</b>	
• at 230 V rated value	10 A
• at 400 V rated value	3 A
• at 500 V rated value	2 A
• at 690 V rated value	1 A
<b>operational current at DC-12</b>	
• at 24 V rated value	10 A
• at 48 V rated value	6 A
• at 60 V rated value	6 A
• at 110 V rated value	3 A
• at 125 V rated value	2 A
• at 220 V rated value	1 A
• at 600 V rated value	0.15 A
<b>operational current at DC-13</b>	
• at 24 V rated value	10 A
• at 48 V rated value	2 A
• at 60 V rated value	2 A
• at 110 V rated value	1 A
• at 125 V rated value	0.9 A
• at 220 V rated value	0.3 A
• at 600 V rated value	0.1 A
<b>contact reliability of auxiliary contacts</b>	1 faulty switching per 100 million (17 V, 1 mA)
<b>UL/CSA ratings</b>	
<b>full-load current (FLA) for 3-phase AC motor</b>	
• at 480 V rated value	40 A
• at 600 V rated value	41 A
<b>yielded mechanical performance [hp]</b>	
• for single-phase AC motor	
— at 110/120 V rated value	3 hp
— at 230 V rated value	7.5 hp
• for 3-phase AC motor	
— at 200/208 V rated value	10 hp
— at 220/230 V rated value	15 hp
— at 460/480 V rated value	30 hp
— at 575/600 V rated value	40 hp
<b>contact rating of auxiliary contacts according to UL</b>	A600 / P600
<b>Short-circuit protection</b>	
design of the miniature circuit breaker for short-circuit protection of the auxiliary circuit up to 230 V	C characteristic: 10 A; 0.4 kA
<b>design of the fuse link</b>	
• for short-circuit protection of the main circuit	
— with type of coordination 1 required	gG: 160 A (690 V, 100 kA), aM: 80 A (690 V, 100 kA), BS88: 125 A (415 V, 80 kA)
— with type of coordination 2 required	gG: 80 A (690 V, 100 kA), aM: 50 A (690 V, 100 kA), BS88: 63 A (415 V, 80 kA)
• for short-circuit protection of the auxiliary switch required	gG: 10 A (500 V, 1 kA)
<b>Installation/ mounting/ dimensions</b>	
<b>mounting position</b>	+/-180° rotation possible on vertical mounting surface; can be tilted forward and backward by +/- 22.5° on vertical mounting surface
fastening method side-by-side mounting	Yes

<b>fastening method</b>	screw and snap-on mounting onto 35 mm DIN rail according to DIN EN 60715
<b>height</b>	114 mm
<b>width</b>	55 mm
<b>depth</b>	130 mm
<b>required spacing</b>	
<ul style="list-style-type: none"> <li>• with side-by-side mounting <ul style="list-style-type: none"> <li>— forwards 10 mm</li> <li>— upwards 10 mm</li> <li>— downwards 10 mm</li> <li>— at the side 0 mm</li> </ul> </li> <li>• for grounded parts <ul style="list-style-type: none"> <li>— forwards 10 mm</li> <li>— upwards 10 mm</li> <li>— at the side 6 mm</li> <li>— downwards 10 mm</li> </ul> </li> <li>• for live parts <ul style="list-style-type: none"> <li>— forwards 10 mm</li> <li>— upwards 10 mm</li> <li>— downwards 10 mm</li> <li>— at the side 6 mm</li> </ul> </li> </ul>	
<b>Connections/ Terminals</b>	
<b>type of electrical connection</b>	
<ul style="list-style-type: none"> <li>• for main current circuit screw-type terminals</li> <li>• for auxiliary and control circuit spring-loaded terminals</li> <li>• at contactor for auxiliary contacts Spring-type terminals</li> <li>• of magnet coil Spring-type terminals</li> </ul>	
<b>type of connectable conductor cross-sections</b>	
<ul style="list-style-type: none"> <li>• for main contacts <ul style="list-style-type: none"> <li>— solid or stranded 2x (1 ... 35 mm<sup>2</sup>), 1x (1 ... 50 mm<sup>2</sup>)</li> <li>— finely stranded with core end processing 2x (1 ... 25 mm<sup>2</sup>), 1x (1 ... 35 mm<sup>2</sup>)</li> </ul> </li> <li>• for AWG cables for main contacts 2x (18 ... 2), 1x (18 ... 1)</li> </ul>	
<b>connectable conductor cross-section for main contacts</b>	
<ul style="list-style-type: none"> <li>• finely stranded with core end processing 1 ... 35 mm<sup>2</sup></li> </ul>	
<b>connectable conductor cross-section for auxiliary contacts</b>	
<ul style="list-style-type: none"> <li>• solid or stranded 0.5 ... 2.5 mm<sup>2</sup></li> <li>• finely stranded with core end processing 0.5 ... 1.5 mm<sup>2</sup></li> <li>• finely stranded without core end processing 0.5 ... 2.5 mm<sup>2</sup></li> </ul>	
<b>type of connectable conductor cross-sections</b>	
<ul style="list-style-type: none"> <li>• for auxiliary contacts <ul style="list-style-type: none"> <li>— solid or stranded 2x (0.5 ... 2.5 mm<sup>2</sup>)</li> <li>— finely stranded with core end processing 2x (0.5 ... 1.5 mm<sup>2</sup>)</li> <li>— finely stranded without core end processing 2x (0.5 ... 2.5 mm<sup>2</sup>)</li> </ul> </li> <li>• for AWG cables for auxiliary contacts 2x (20 ... 14)</li> </ul>	
<b>AWG number as coded connectable conductor cross section for main contacts</b>	18 ... 1
<b>AWG number as coded connectable conductor cross section for auxiliary contacts</b>	20 ... 14
<b>Safety related data</b>	
<b>product function</b>	
<ul style="list-style-type: none"> <li>• mirror contact according to IEC 60947-4-1 Yes</li> <li>• positively driven operation according to IEC 60947-5-1 No</li> <li>• suitable for safety function Yes</li> </ul>	
suitability for use safety-related switching OFF	Yes
<b>service life maximum</b>	20 a
<b>test wear-related service life necessary</b>	Yes
<b>proportion of dangerous failures</b>	
<ul style="list-style-type: none"> <li>• with low demand rate according to SN 31920 40 %</li> <li>• with high demand rate according to SN 31920 73 %</li> </ul>	
<b>B10 value with high demand rate according to SN 31920</b>	1 000 000

failure rate [FIT] with low demand rate according to SN 31920	100 FIT
ISO 13849	
device type according to ISO 13849-1	3
overdimensioning according to ISO 13849-2 necessary	Yes
IEC 61508	
safety device type according to IEC 61508-2	Type A
Electrical Safety	
protection class IP on the front according to IEC 60529	IP20
touch protection on the front according to IEC 60529	finger-safe, for vertical contact from the front

**Approvals Certificates**

Environmental Product Declaration	
<ul style="list-style-type: none"> <li>global warming potential [CO2 eq] / during manufacturing</li> <li>global warming potential [CO2 eq] / during operation</li> <li>global warming potential [CO2 eq] / after end of life</li> <li>global warming potential [CO2 eq] / total</li> </ul>	<ul style="list-style-type: none"> <li>5.88 kg</li> <li>102 kg</li> <li>-0.988 kg</li> <li>107 kg</li> </ul>





**Environment      General Product Approval**

[Environmental Confirmations](#)



[Miscellaneous](#)

**General Product Approval      EMV      Test Certificates**





[Special Test Certificate](#)



**Test Certificates      Maritime application**

[Type Test Certificates/Test Report](#)





**Maritime application      other**



[Miscellaneous](#)
[Confirmation](#)
[Confirmation](#)

**Railway**

[Special Test Certificate](#)

**Further information**

Information on the packaging  
<https://support.industry.siemens.com/cs/ww/en/view/109813875>  
 Information for data generation and storage  
<https://support.industry.siemens.com/cs/ww/en/view/109995012>  
 Information- and Downloadcenter (Catalogs, Brochures,...)  
<https://www.siemens.com/ic10>  
 Industry Mall (Online ordering system)  
<https://mall.industry.siemens.com/mall/en/en/Catalog/product?mlfb=3RT2035-3NF30>  
 Service&Support (Manuals, Certificates, Characteristics, FAQs,...)  
<https://support.industry.siemens.com/cs/ww/en/ps/3RT2035-3NF30>

Image database (product images, 2D dimension drawings, 3D models, device circuit diagrams, EPLAN macros, ...)

[https://www.automation.siemens.com/bilddb/cax\\_de.aspx?mlfb=3RT2035-3NF30&lang=en](https://www.automation.siemens.com/bilddb/cax_de.aspx?mlfb=3RT2035-3NF30&lang=en)

Cax online generator

<https://support.automation.siemens.com/WW/CAXorder/default.aspx?lang=en&mlfb=3RT2035-3NF30>

Characteristic curves

[https://curves.simaris.siemens.com/curves/<mmp\\_prod\\_noCOMP='HAUPT'></mmp\\_prod\\_no>](https://curves.simaris.siemens.com/curves/<mmp_prod_noCOMP='HAUPT'></mmp_prod_no>)

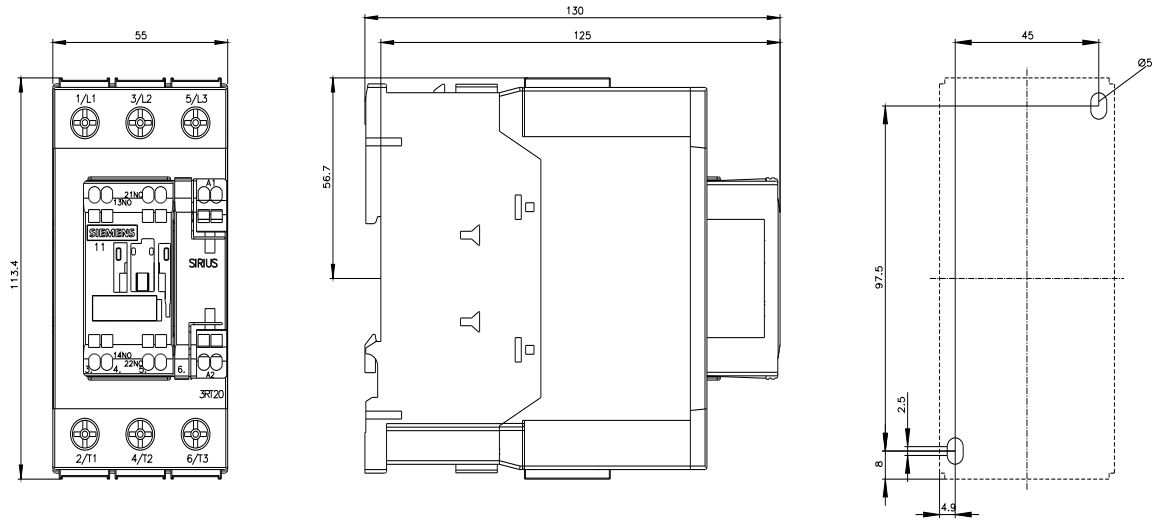

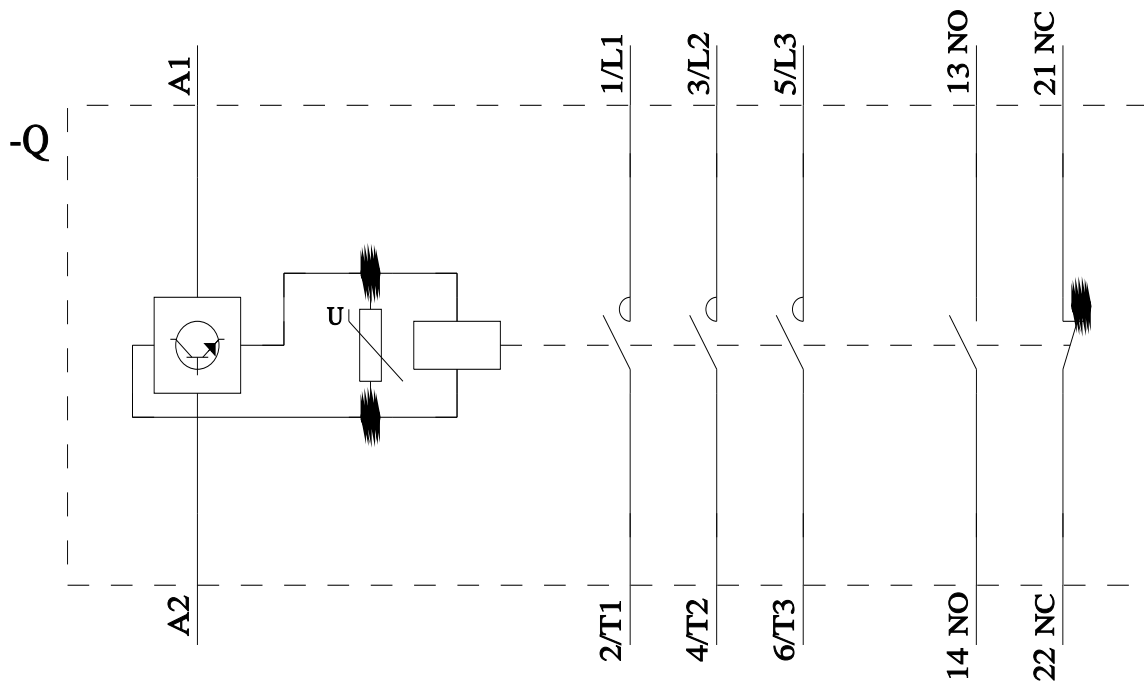

last modified:

4/4/2026 