



Miniature circuit-breaker 440 V DC 10kA, 2-pole, C, 2A

Model	
product brand name	SENTRON
product designation	Miniature circuit breaker
design of the product	Machine manufacture / industry
General technical data	
number of poles	2
design of pole	2P
tripping characteristic class	C
mechanical service life (operating cycles) typical	10 000
overvoltage category	3
degree of pollution	3
Voltage	
type of voltage of the operating voltage	DC
insulation voltage (Ui)	
• at DC rated value	440 V
• operational current	
— at 40 °C rated value	1.86 A
— at 50 °C rated value	1.72 A
— at 55 °C rated value	1.64 A
• operational current at AC rated value	2 A
Supply voltage	
supply voltage	
• at DC rated value	440 V
operating voltage at DC rated value maximum	500 V
Protection class	
protection class IP	IP20, with connected conductors
Breaking Capacity	
switching capacity current	
• at DC according to IEC 60947-2 rated value	10 kA
Dissipation	
power loss [W] for rated value of the current at AC in hot operating state per pole	1.6 W
suitability for operation	Infrastructure / Industry / Mobility
Product details	
product feature touch protection	Yes
product component	
• combined terminal top	Yes
• combined terminal bottom	Yes

• neutral conductor switching	No
product feature properties for main switches in accordance with EN 60204-1	Yes
product feature halogen-free	Yes
product feature sealable	Yes
product feature silicon-free	Yes
product extension installable supplementary devices	Yes

Connections

connectable conductor cross-section solid	
• minimum	0.75 mm ²
• maximum	35 mm ²
connectable conductor cross-section stranded	
• minimum	0.75 mm ²
• maximum	35 mm ²
connectable conductor cross-section finely stranded with core end processing	
• minimum	0.75 mm ²
• maximum	25 mm ²
tightening torque [lbf-in] with screw-type terminals	
• minimum	22 lbf-in
• maximum	31 lbf-in
tightening torque with screw-type terminals	
• minimum	2.5 N·m
• maximum	3.5 N·m
position of power supply cord	Consider polarity

Mechanical Design

height	90 mm
width	36 mm
depth	76 mm
installation depth	70 mm
number of modular width units	2
fastening method	DIN rail
mounting position	any
Net Weight	0.32 kg

Environmental conditions

influence of the surrounding temperature	max. 95% RH up to 55°C
vibration resistance according to IEC 60068-2-6	±1mm at 5 to 25 Hz; 50 m/s ² at 25 to 150 Hz and 60 m/s ² at 35 Hz (4 sec)
ambient temperature during operation	
• minimum	-25 °C
• maximum	55 °C
ambient temperature during storage	
• minimum	-40 °C
• maximum	75 °C
number of test cycles for environmental testing according to IEC 60068-2-30	28

Approvals Certificates

Environment	General Product Approval
-------------	--------------------------

[Environmental Confirmations](#)

[Environmental Confirmations](#)



[Miscellaneous](#)



[Confirmation](#)

General Product Approval	Maritime application	other	Railway
--------------------------	----------------------	-------	---------



[CCS \(China Classification Society\)](#)



[Confirmation](#)

[Confirmation](#)

[Transport Information](#)

Further information

Information on the packaging

<https://support.industry.siemens.com/cs/ww/en/view/109813875>

Information for data generation and storage

<https://support.industry.siemens.com/cs/ww/en/view/109995012>

Information- and Downloadcenter (Catalogs, Brochures,...)

<https://www.siemens.com/lowvoltage/catalogs>

Industry Mall (Online ordering system)

<https://mall.industry.siemens.com/mall/en/en/Catalog/product?mlfb=5SY5202-7CC>

Service&Support (Manuals, Certificates, Characteristics, FAQs,...)

<https://support.industry.siemens.com/cs/ww/en/ps/5SY5202-7CC>

Image database (product images, 2D dimension drawings, 3D models, device circuit diagrams, ...)

https://www.automation.siemens.com/bilddb/cax_en.aspx?mlfb=5SY5202-7CC

CAx-Online-Generator

<https://www.siemens.com/cax>

Tender specifications

<https://www.siemens.com/specifications>

Characteristic curves

[https://curves.simaris.siemens.com/curves/<mmp_prod_noCOMP="HAUPT"></mmp_prod_no>](https://curves.simaris.siemens.com/curves/<mmp_prod_noCOMP=)

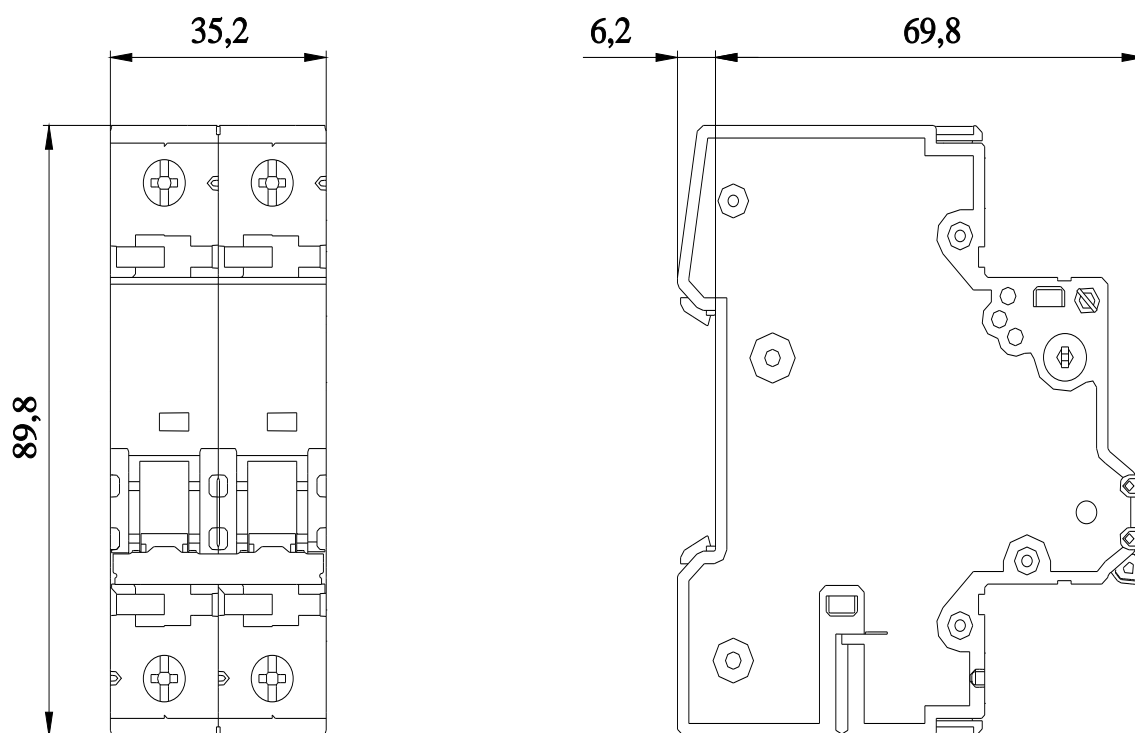



CB



