



Contactor relay, 3 NO + 1 NC, AC 24 V, 50/60 Hz, size S00, screw terminal

product brand name	SIRIUS
product designation	Contactor relay
product type designation	3RH6
General technical data	
size of contactor	S00
product extension auxiliary switch	Yes
power loss [W] for rated value of the current without load current share typical	1.05 W
insulation voltage with degree of pollution 3 at AC rated value	690 V
surge voltage resistance rated value	6 kV
shock resistance at rectangular impulse	
• at AC	7,3 g / 5 ms, 4,7 g / 10 ms
shock resistance with sine pulse	
• at AC	11,4 g / 5 ms, 7,3 g / 10 ms
mechanical service life (operating cycles)	
• of contactor typical	30 000 000
• of the contactor with added auxiliary switch block typical	10 000 000
Substance Prohibitance (day/month/year)	05/01/2012
Net Weight	0.22 kg
Ambient conditions	
installation altitude at height above sea level maximum	2 000 m
ambient temperature	
• during operation	-25 ... +60 °C
• during storage	-55 ... +80 °C
Main circuit	
no-load switching frequency	
• at AC	10 000 1/h
• at DC	10 000 1/h
Control circuit/ Control	
type of voltage of the control supply voltage	AC
control supply voltage at AC	
• at 50 Hz rated value	24 V
• at 60 Hz rated value	24 V
operating range factor control supply voltage rated value of magnet coil at AC	
• at 50 Hz	0.8 ... 1.1
• at 60 Hz	0.85 ... 1.1
apparent pick-up power of magnet coil at AC	37 VA
inductive power factor with closing power of the coil	0.8

apparent holding power of magnet coil at AC	5.7 VA
inductive power factor with the holding power of the coil	0.25
Auxiliary circuit	
number of NC contacts for auxiliary contacts	1
number of NO contacts for auxiliary contacts	3
identification number and letter for switching elements	31 E
operational current at AC-12 maximum	6 A
operational current at AC-15	
• at 230 V rated value	10 A
• at 400 V rated value	3 A
• at 690 V rated value	1 A
operational current at 1 current path at DC-12	
• at 24 V rated value	6 A
• at 110 V rated value	3 A
• at 220 V rated value	1 A
operational current with 2 current paths in series at DC-12	
• at 24 V rated value	6 A
• at 110 V rated value	4 A
• at 220 V rated value	2 A
operational current with 3 current paths in series at DC-12	
• at 24 V rated value	6 A
• at 110 V rated value	6 A
• at 220 V rated value	3.6 A
operating frequency at DC-12 maximum	1 000 1/h
operational current at 1 current path at DC-13	
• at 24 V rated value	6 A
• at 110 V rated value	1 A
• at 220 V rated value	0.3 A
operational current with 2 current paths in series at DC-13	
• at 24 V rated value	6 A
• at 110 V rated value	1.3 A
• at 220 V rated value	0.9 A
operational current with 3 current paths in series at DC-13	
• at 24 V rated value	6 A
• at 110 V rated value	3 A
• at 220 V rated value	1.2 A
operating frequency at DC-13 maximum	1 000 1/h
contact reliability of auxiliary contacts	1 faulty switching per 100 million (17 V, 1 mA)
Short-circuit protection	
design of the miniature circuit breaker for short-circuit protection of the auxiliary circuit up to 230 V	C characteristic: 6 A; 0.4 kA
design of the fuse link for short-circuit protection of the auxiliary switch required	fuse gL/gG: 10 A
Installation/ mounting/ dimensions	
mounting position	+/-180° rotation possible on vertical mounting surface; can be tilted forward and backward by +/- 22.5° on vertical mounting surface
fastening method	screw and snap-on mounting onto 35 mm DIN rail
height	57.5 mm
width	45 mm
depth	73 mm
Connections/ Terminals	
type of electrical connection for auxiliary and control circuit	screw-type terminals
type of connectable conductor cross-sections	
• for auxiliary contacts	
— solid or stranded	2x (0.5 ... 1.5 mm ²), 2x (0.75 ... 2.5 mm ²), 2x 4 mm ²
— finely stranded with core end processing	2x (0.5 ... 1.5 mm ²), 2x (0.75 ... 2.5 mm ²)
• for AWG cables for auxiliary contacts	2x (20 ... 16), 2x (18 ... 14), 2x 12
Safety related data	
product function positively driven operation according to IEC 60947-5-1	Yes

Electrical Safety	
protection class IP on the front according to IEC 60529	IP20
touch protection on the front according to IEC 60529	finger-safe, for vertical contact from the front
Approvals Certificates	
General Product Approval	



[Confirmation](#)



Maritime application	other	Environment
----------------------	-------	-------------

[CCS \(China Classification Society\)](#)

[Confirmation](#)



[Environmental Confirmations](#)

Further information

Service&Support (Manuals, Certificates, Characteristics, FAQs,...)
<https://support.industry.siemens.com/cs/products?pnid=16027&lc=en-CN>

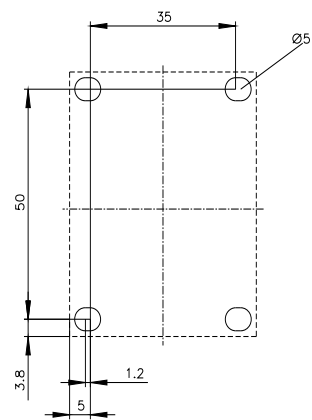
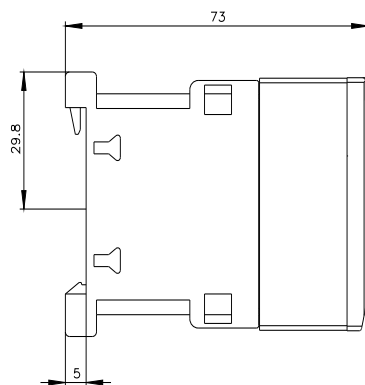
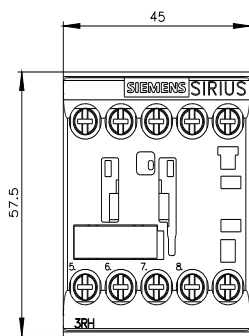

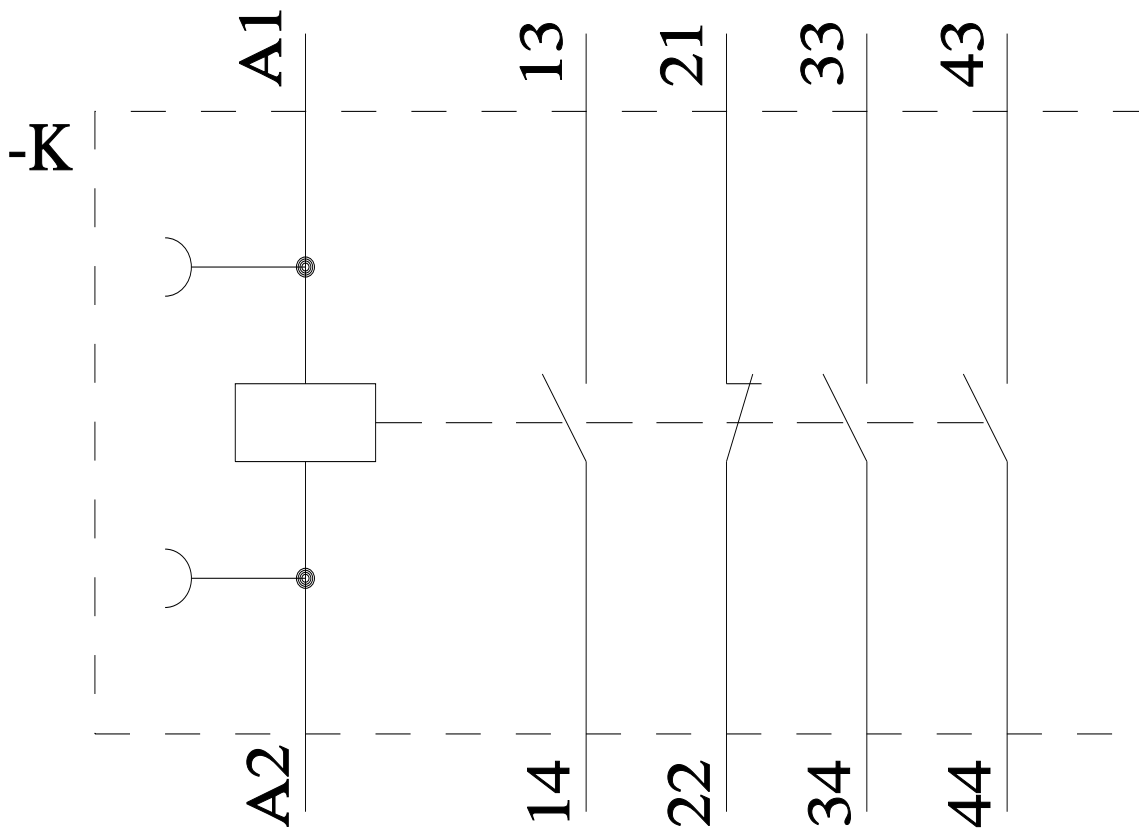
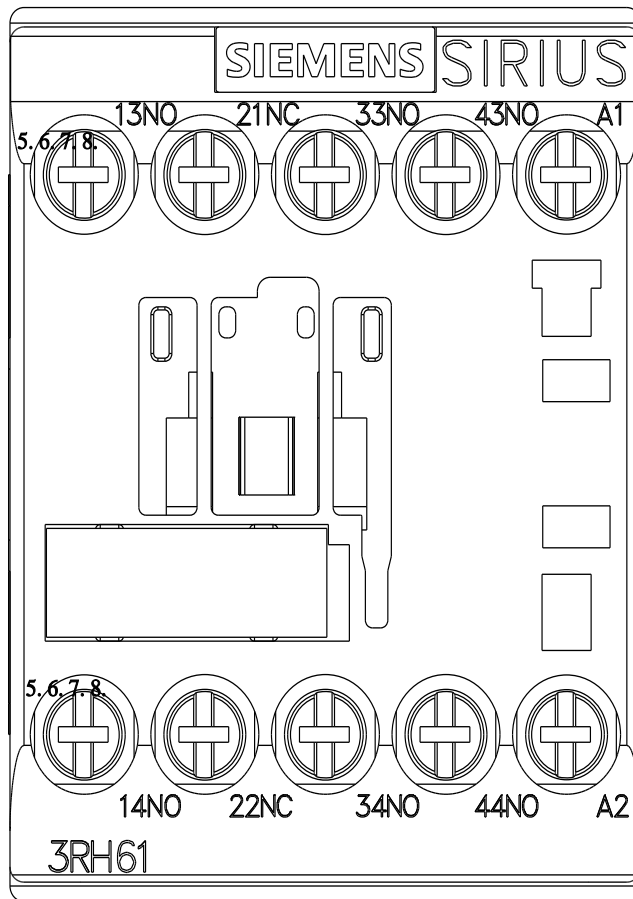

last modified:

4/4/2026