



contactor relay railway, 3 NO, 110 V DC, 0.7-1.25\*Us, with integrated suppressor diode, spring-loaded terminal, frame size S00

product brand name	SIRIUS
product designation	Contactor relay for railway applications
product type designation	3RH2
<b>General technical data</b>	
size of contactor	S00
product extension auxiliary switch	Yes
power loss [W] for rated value of the current without load current share typical	2.8 W
insulation voltage with degree of pollution 3 at AC rated value	690 V
surge voltage resistance rated value	6 kV
shock resistance at rectangular impulse	
• at DC	10 g / 5 ms, 5 g / 10 ms
shock resistance with sine pulse	
• at DC	15 g / 5 ms, 8 g / 10 ms
mechanical service life (operating cycles)	
• of contactor typical	30 000 000
• of the contactor with added electronically optimized auxiliary switch block typical	5 000 000
• of the contactor with added auxiliary switch block typical	10 000 000
reference code according to IEC 81346-2	K
Substance Prohibition (day/month/year)	10/01/2009
SVHC substance name	Lead CAS-No. 7439-92-1
Net Weight	0.337 g
<b>Ambient conditions</b>	
installation altitude at height above sea level maximum	2 000 m
ambient temperature	
• during operation	-40 ... +70 °C
• during storage	-55 ... +80 °C
relative humidity minimum	10 %
relative humidity at 55 °C according to IEC 60068-2-30 maximum	95 %
<b>Main circuit</b>	
no-load switching frequency	
• at AC	10 000 1/h
• at DC	10 000 1/h
<b>Control circuit/ Control</b>	
type of voltage of the control supply voltage	DC
control supply voltage at DC rated value	110 V
operating range factor control supply voltage rated value of magnet coil at DC	

• initial value	0.7
• full-scale value	1.25
<b>design of the surge suppressor</b>	suppressor diode
<b>closing power of magnet coil at DC</b>	13 W
<b>holding power of magnet coil at DC</b>	4 W
<b>closing delay</b>	
• at DC	25 ... 130 ms
<b>opening delay</b>	
• at DC	7 ... 20 ms
<b>arcing time</b>	10 ... 15 ms
<b>Auxiliary circuit</b>	
<b>number of NC contacts for auxiliary contacts</b>	0
• instantaneous contact	0
<b>number of NO contacts for auxiliary contacts</b>	3
• instantaneous contact	3
<b>identification number and letter for switching elements</b>	21
operational current at AC-12 maximum	10 A
<b>operational current at AC-15</b>	
• at 230 V rated value	10 A
• at 400 V rated value	3 A
• at 500 V rated value	2 A
• at 690 V rated value	1 A
<b>operational current at 1 current path at DC-12</b>	
• at 24 V rated value	10 A
• at 110 V rated value	3 A
• at 220 V rated value	1 A
• at 440 V rated value	0.3 A
• at 600 V rated value	0.15 A
<b>operational current with 2 current paths in series at DC-12</b>	
• at 24 V rated value	10 A
• at 60 V rated value	10 A
• at 110 V rated value	4 A
• at 220 V rated value	2 A
• at 440 V rated value	1.3 A
• at 600 V rated value	0.65 A
<b>operational current with 3 current paths in series at DC-12</b>	
• at 24 V rated value	10 A
• at 60 V rated value	10 A
• at 110 V rated value	10 A
• at 220 V rated value	3.6 A
• at 440 V rated value	2.5 A
• at 600 V rated value	1.8 A
<b>operating frequency at DC-12 maximum</b>	1 000 1/h
<b>operational current at 1 current path at DC-13</b>	
• at 24 V rated value	10 A
• at 110 V rated value	1 A
• at 220 V rated value	0.3 A
• at 440 V rated value	0.14 A
• at 600 V rated value	0.1 A
<b>operational current with 2 current paths in series at DC-13</b>	
• at 24 V rated value	10 A
• at 60 V rated value	3.5 A
• at 110 V rated value	1.3 A
• at 220 V rated value	0.9 A
• at 440 V rated value	0.2 A
• at 600 V rated value	0.1 A
<b>operational current with 3 current paths in series at DC-13</b>	
• at 24 V rated value	10 A
• at 60 V rated value	4.7 A

<ul style="list-style-type: none"> <li>• at 110 V rated value</li> <li>• at 220 V rated value</li> <li>• at 440 V rated value</li> <li>• at 600 V rated value</li> </ul>	3 A 1.2 A 0.5 A 0.26 A
<b>operating frequency at DC-13 maximum</b>	1 000 1/h
<b>contact reliability of auxiliary contacts</b>	1 faulty switching per 100 million (17 V, 1 mA)
<b>UL/CSA ratings</b>	
<b>contact rating of auxiliary contacts according to UL</b>	A600 / Q600
<b>Short-circuit protection</b>	
design of the miniature circuit breaker for short-circuit protection of the auxiliary circuit up to 230 V	C characteristic: 10 A; 0.4 kA
design of the fuse link for short-circuit protection of the auxiliary switch required	gG: 10 A (690 V, 1 kA)
<b>Installation/ mounting/ dimensions</b>	
<b>mounting position</b>	+/-180° rotation possible on vertical mounting surface; can be tilted forward and backward by +/- 22.5° on vertical mounting surface
fastening method side-by-side mounting	Yes
<b>fastening method</b>	screw and snap-on mounting onto 35 mm DIN rail
<b>height</b>	70 mm
<b>width</b>	45 mm
<b>depth</b>	116 mm
<b>required spacing</b>	
<ul style="list-style-type: none"> <li>• with side-by-side mounting               <ul style="list-style-type: none"> <li>— forwards</li> <li>— upwards</li> <li>— downwards</li> <li>— at the side</li> </ul> </li> <li>• for grounded parts               <ul style="list-style-type: none"> <li>— forwards</li> <li>— upwards</li> <li>— at the side</li> <li>— downwards</li> </ul> </li> <li>• for live parts               <ul style="list-style-type: none"> <li>— forwards</li> <li>— upwards</li> <li>— downwards</li> <li>— at the side</li> </ul> </li> </ul>	10 mm 10 mm 10 mm 0 mm  10 mm 10 mm 6 mm 10 mm  10 mm 10 mm 10 mm 6 mm
<b>Connections/ Terminals</b>	
type of electrical connection for auxiliary and control circuit	spring-loaded terminals
<b>connectable conductor cross-section for auxiliary contacts</b>	
<ul style="list-style-type: none"> <li>• solid or stranded</li> <li>• finely stranded with core end processing</li> <li>• finely stranded without core end processing</li> </ul>	0.5 ... 4 mm <sup>2</sup> 0.5 ... 2.5 mm <sup>2</sup> 0.5 ... 2.5 mm <sup>2</sup>
<b>type of connectable conductor cross-sections</b>	
<ul style="list-style-type: none"> <li>• for auxiliary contacts               <ul style="list-style-type: none"> <li>— solid or stranded</li> <li>— finely stranded with core end processing</li> <li>— finely stranded without core end processing</li> </ul> </li> <li>• for AWG cables for auxiliary contacts</li> </ul>	2x (0.5 ... 4 mm <sup>2</sup> ) 2x (0.5 ... 2.5 mm <sup>2</sup> ) 2x (0.5 ... 2.5 mm <sup>2</sup> ) 2x (20 ... 12)
<b>AWG number as coded connectable conductor cross section for auxiliary contacts</b>	20 ... 12
<b>Safety related data</b>	
product function positively driven operation according to IEC 60947-5-1	Yes
<b>proportion of dangerous failures</b>	
<ul style="list-style-type: none"> <li>• with low demand rate according to SN 31920</li> <li>• with high demand rate according to SN 31920</li> </ul>	40 % 73 %
<b>B10 value with high demand rate according to SN 31920</b>	1 000 000; With 0.3 x I <sub>e</sub>
<b>failure rate [FIT] with low demand rate according to SN 31920</b>	100 FIT

IEC 61508	
<b>T1 value</b>	20 a
<ul style="list-style-type: none"> <li>• for proof test interval or service life according to IEC 61508</li> </ul>	

Electrical Safety	
<b>protection class IP on the front according to IEC 60529</b>	IP20
<b>touch protection on the front according to IEC 60529</b>	finger-safe, for vertical contact from the front

**Approvals Certificates**

Environmental Product Declaration	
<ul style="list-style-type: none"> <li>• global warming potential [CO2 eq] / during manufacturing</li> <li>• global warming potential [CO2 eq] / during operation</li> <li>• global warming potential [CO2 eq] / after end of life</li> <li>• global warming potential [CO2 eq] / total</li> </ul>	1.3 kg 132 kg -0.227 kg 133 kg

<b>Environment</b>	<b>General Product Approval</b>
--------------------	---------------------------------

[Environmental Confirmations](#)







<b>General Product Approval</b>	<b>EMV</b>	<b>Functional Safety</b>
---------------------------------	------------	--------------------------











[Type Examination Certificate](#)



<b>Test Certificates</b>	<b>Maritime application</b>
--------------------------	-----------------------------

[Special Test Certificate](#)

[Type Test Certificates/Test Report](#)

<b>Maritime application</b>	<b>other</b>
-----------------------------	--------------

[Confirmation](#)



[Miscellaneous](#)

<b>Railway</b>	<b>Dangerous goods</b>
----------------	------------------------

[Special Test Certificate](#)

[Transport Information](#)

**Further information**

Information on the packaging  
<https://support.industry.siemens.com/cs/ww/en/view/109813875>

Information for data generation and storage  
<https://support.industry.siemens.com/cs/ww/en/view/109995012>

Information- and Downloadcenter (Catalogs, Brochures,...)  
<https://www.siemens.com/ic10>

Industry Mall (Online ordering system)  
<https://mall.industry.siemens.com/mall/en/en/Catalog/product?mlfb=3RH2131-2KF40-0LA0>

Service&Support (Manuals, Certificates, Characteristics, FAQs,...)  
<https://support.industry.siemens.com/cs/ww/en/ps/3RH2131-2KF40-0LA0>

Image database (product images, 2D dimension drawings, 3D models, device circuit diagrams, EPLAN macros, ...)  
[https://www.automation.siemens.com/bilddb/cax\\_de.aspx?mlfb=3RH2131-2KF40-0LA0&lang=en](https://www.automation.siemens.com/bilddb/cax_de.aspx?mlfb=3RH2131-2KF40-0LA0&lang=en)

Cax online generator  
<https://support.automation.siemens.com/WWW/CAXorder/default.aspx?lang=en&mlfb=3RH2131-2KF40-0LA0>

Characteristic curves

[https://curves.siemens.com/curves/<mmp\\_prod\\_noCOMP='HAUPT'></mmp\\_prod\\_no>](https://curves.siemens.com/curves/<mmp_prod_noCOMP='HAUPT'></mmp_prod_no>)

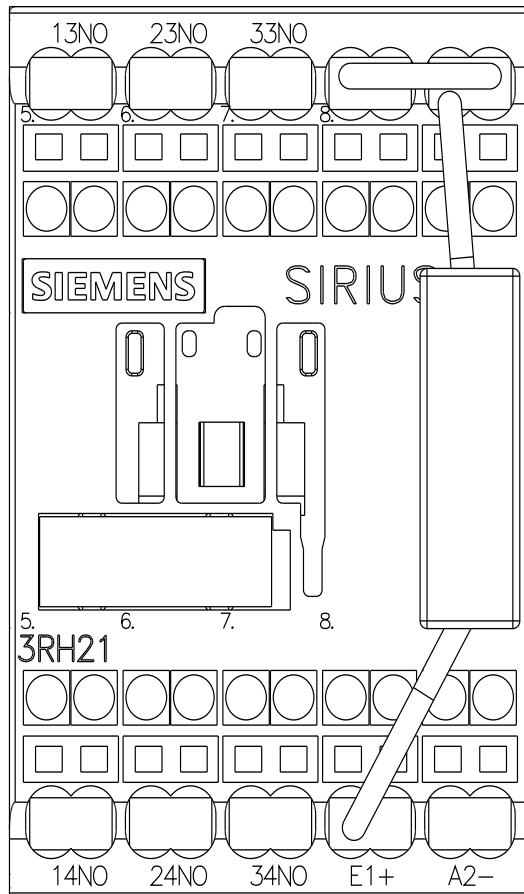
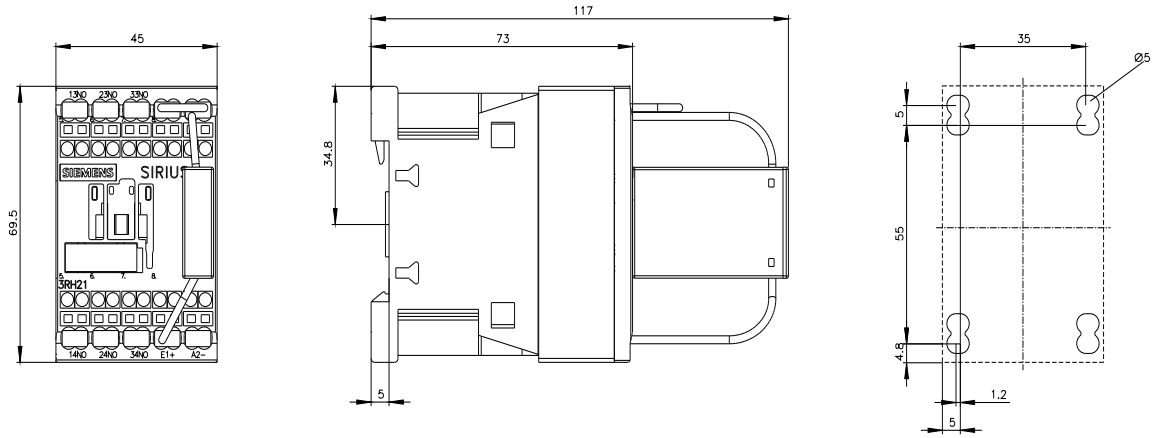

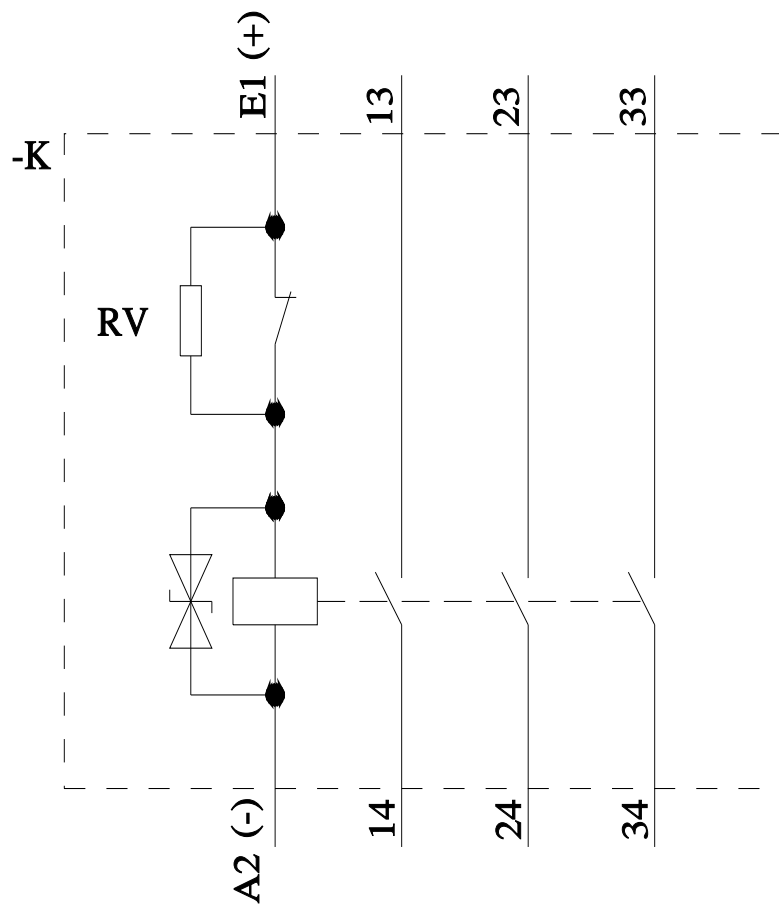

last modified:

4/4/2026