



Circuit breaker 20 A rated current 20 A, for starter combination, short-circuit release 260 A, screw terminal standard switching capacity SIRIUS

product brand name	SIRIUS
product designation	Circuit breaker
design of the product	for starter combinations
product type designation	3RV5
General technical data	
size of the circuit-breaker	S2
power loss [W] total typical	12 W
power loss [W] for rated value of the current at AC in hot operating state per pole	4.8 W
type of calculation of power loss current-dependent	quadratic
insulation voltage with degree of pollution 3 at AC rated value	690 V
surge voltage resistance rated value	6 kV
shock resistance according to IEC 60068-2-27	25 g / 11 ms
Substance Prohibitance (day/month/year)	07/01/2006
SVHC substance name	Lead CAS-No. 7439-92-1
Net Weight	1.066 kg
Ambient conditions	
installation altitude at height above sea level maximum	2 000 m
ambient temperature	
• during operation	-20 ... +60 °C
• during transport	-50 ... +80 °C
relative humidity during operation	10 ... 95 %
Main circuit	
number of poles for main current circuit	3
operating voltage	
• rated value	690 V
• at AC-3 rated value maximum	690 V
operating frequency rated value	50 ... 60 Hz
operational current rated value	20 A
operational current at AC-3 at 400 V rated value	20 A
operating frequency at AC-3 maximum	15 1/h
Protective and monitoring functions	
maximum short-circuit current breaking capacity (I _{cu}) at AC at 400 V rated value	50 kA
operating short-circuit current breaking capacity (I _{cs}) at AC at 400 V rated value	25 kA
response value current of instantaneous short-circuit trip unit	260 A
Short-circuit protection	
product function short circuit protection	Yes
design of the short-circuit trip	magnetic

Installation/ mounting/ dimensions	
mounting position	any
fastening method	screw and snap-on mounting onto 35 mm DIN rail according to DIN EN 50022
height	140 mm
width	55 mm
depth	149 mm
required spacing for grounded parts	
• forwards	140 mm
• backwards	0 mm
• upwards	50 mm
• at the side	30 mm
• downwards	50 mm

Connections/ Terminals	
type of electrical connection	
• for main current circuit	screw-type terminals with box terminals
arrangement of electrical connectors for main current circuit	Top and bottom
type of connectable conductor cross-sections for main contacts	
• solid or stranded	2x (0.75 ... 25 mm ²), 1x (0.75 ... 35 mm ²)
• finely stranded with core end processing	2x (0.75 ... 16 mm ²), 1x (0.75 ... 25 mm ²)
tightening torque	
• for main contacts with screw-type terminals	3 ... 4.5 N·m

Electrical Safety	
protection class IP on the front according to IEC 60529	IP20
touch protection on the front according to IEC 60529	finger-safe, for vertical contact from the front

Approvals Certificates

General Product Approval	Test Certificates
--------------------------	-------------------



[Confirmation](#)



[Type Test Certificates/Test Report](#)

Maritime application	other	Environment
----------------------	-------	-------------

[CCS \(China Classification Society\)](#)

[Miscellaneous](#)

[Confirmation](#)



[Environmental Confirmations](#)

Further information

Service&Support (Manuals, Certificates, Characteristics, FAQs,...)
<https://support.industry.siemens.com/cs/products?pnid=16027&lc=en-CN>

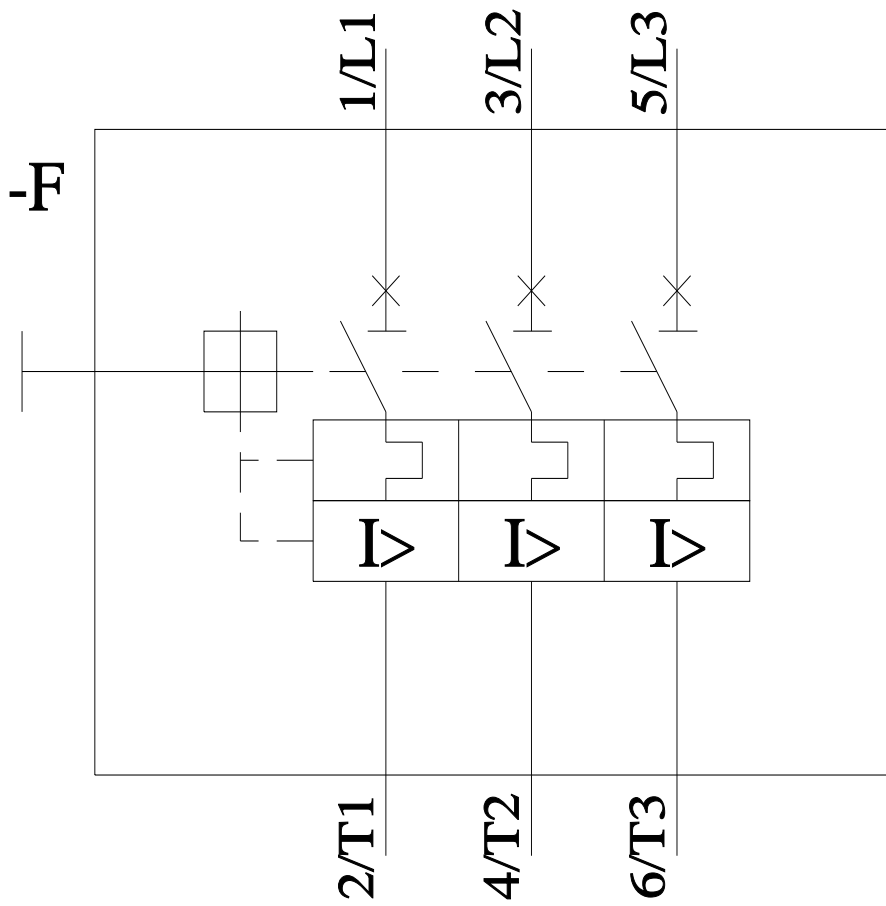

last modified:

5/16/2026 