



power contactor, AC-3e/AC-3, 9 A, 4 kW / 400 V, 3-pole, 24 V DC, 0.85-1.85* U_c, with varistor plugged on, auxiliary contacts: 1 NO, spring-loaded terminal, frame size: S00, no auxiliary switch can be added

| | |
|--|------------------------------|
| product brand name | SIRIUS |
| product designation | Power contactor |
| product type designation | 3RT2 |
| General technical data | |
| size of contactor | S00 |
| product extension | |
| • function module for communication | No |
| • auxiliary switch | No |
| power loss [W] for rated value of the current | |
| • at AC in hot operating state | 0.9 W |
| • at AC in hot operating state per pole | 0.3 W |
| • without load current share typical | 1.6 W |
| type of calculation of power loss current-dependent | quadratic |
| insulation voltage | |
| • of main circuit with degree of pollution 3 rated value | 690 V |
| • of auxiliary circuit with degree of pollution 3 rated value | 690 V |
| surge voltage resistance | |
| • of main circuit rated value | 6 kV |
| • of auxiliary circuit rated value | 6 kV |
| maximum permissible voltage for protective separation between coil and main contacts according to EN 60947-1 | 400 V |
| shock resistance at rectangular impulse | |
| • at DC | 6,7 g / 5 ms, 4,2 g / 10 ms |
| shock resistance with sine pulse | |
| • at DC | 10,5 g / 5 ms, 6,6 g / 10 ms |
| mechanical service life (operating cycles) | |
| • of contactor typical | 30 000 000 |
| reference code according to IEC 81346-2 | Q |
| Substance Prohibitance (day/month/year) | 10/01/2009 |
| SVHC substance name | Lead CAS-No. 7439-92-1 |
| Net Weight | 0.324 g |
| Ambient conditions | |
| installation altitude at height above sea level maximum | 2 000 m |
| ambient temperature | |
| • during operation | -25 ... +60 °C |
| • during storage | -55 ... +80 °C |
| relative humidity minimum | 10 % |
| relative humidity at 55 °C according to IEC 60068-2-30 maximum | 95 % |

| Main circuit | |
|--|--|
| number of poles for main current circuit | 3 |
| number of NO contacts for main contacts | 3 |
| number of NC contacts for main contacts | 0 |
| operating voltage | |
| <ul style="list-style-type: none"> ● at AC-3 rated value maximum | 690 V |
| <ul style="list-style-type: none"> ● at AC-3e rated value maximum | 690 V |
| operational current | |
| <ul style="list-style-type: none"> ● at AC-1 at 400 V at ambient temperature 40 °C rated value | 22 A |
| <ul style="list-style-type: none"> ● at AC-1 <ul style="list-style-type: none"> — up to 690 V at ambient temperature 40 °C rated value — up to 690 V at ambient temperature 60 °C rated value | 22 A 20 A |
| <ul style="list-style-type: none"> ● at AC-3 <ul style="list-style-type: none"> — at 400 V rated value — at 500 V rated value — at 690 V rated value | 9 A 7.7 A 6.7 A |
| <ul style="list-style-type: none"> ● at AC-3e <ul style="list-style-type: none"> — at 400 V rated value — at 500 V rated value — at 690 V rated value | 9 A 7.7 A 6.7 A |
| <ul style="list-style-type: none"> ● at AC-4 at 400 V rated value | 8.5 A |
| <ul style="list-style-type: none"> ● at AC-5a up to 690 V rated value | 19.4 A |
| <ul style="list-style-type: none"> ● at AC-5b up to 400 V rated value | 7.4 A |
| <ul style="list-style-type: none"> ● at AC-6a <ul style="list-style-type: none"> — up to 230 V for current peak value n=20 rated value — up to 400 V for current peak value n=20 rated value — up to 500 V for current peak value n=20 rated value — up to 690 V for current peak value n=20 rated value | 5.3 A 5.3 A 5.3 A 5 A |
| <ul style="list-style-type: none"> ● at AC-6a <ul style="list-style-type: none"> — up to 230 V for current peak value n=30 rated value — up to 400 V for current peak value n=30 rated value — up to 500 V for current peak value n=30 rated value — up to 690 V for current peak value n=30 rated value | 3.5 A 3.5 A 3.6 A 3.3 A |
| minimum cross-section in main circuit at maximum AC-1 rated value | 4 mm ² |
| operational current for approx. 200000 operating cycles at AC-4 | |
| <ul style="list-style-type: none"> ● at 400 V rated value | 4.1 A |
| <ul style="list-style-type: none"> ● at 690 V rated value | 3.3 A |
| operational current | |
| <ul style="list-style-type: none"> ● at 1 current path at DC-1 <ul style="list-style-type: none"> — at 24 V rated value — at 60 V rated value — at 110 V rated value — at 220 V rated value — at 440 V rated value — at 600 V rated value | 20 A 20 A 2.1 A 0.8 A 0.6 A 0.6 A |
| <ul style="list-style-type: none"> ● with 2 current paths in series at DC-1 <ul style="list-style-type: none"> — at 24 V rated value — at 60 V rated value — at 110 V rated value — at 220 V rated value — at 440 V rated value — at 600 V rated value | 20 A 20 A 12 A 1.6 A 0.8 A 0.7 A |
| <ul style="list-style-type: none"> ● with 3 current paths in series at DC-1 <ul style="list-style-type: none"> — at 24 V rated value — at 60 V rated value | 20 A 20 A |

| | |
|---|---|
| — at 110 V rated value | 20 A |
| — at 220 V rated value | 20 A |
| — at 440 V rated value | 1.3 A |
| — at 600 V rated value | 1 A |
| ● at 1 current path at DC-3 at DC-5 | |
| — at 24 V rated value | 20 A |
| — at 60 V rated value | 0.5 A |
| — at 110 V rated value | 0.15 A |
| ● with 2 current paths in series at DC-3 at DC-5 | |
| — at 24 V rated value | 20 A |
| — at 60 V rated value | 5 A |
| — at 110 V rated value | 0.35 A |
| ● with 3 current paths in series at DC-3 at DC-5 | |
| — at 24 V rated value | 20 A |
| — at 60 V rated value | 20 A |
| — at 110 V rated value | 20 A |
| — at 220 V rated value | 1.5 A |
| — at 440 V rated value | 0.2 A |
| — at 600 V rated value | 0.2 A |
| operating power | |
| ● at AC-3 | |
| — at 230 V rated value | 2.2 kW |
| — at 400 V rated value | 4 kW |
| — at 500 V rated value | 4 kW |
| — at 690 V rated value | 5.5 kW |
| ● at AC-3e | |
| — at 230 V rated value | 2.2 kW |
| — at 400 V rated value | 4 kW |
| — at 500 V rated value | 4 kW |
| — at 690 V rated value | 5.5 kW |
| operating power for approx. 200000 operating cycles at AC-4 | |
| ● at 400 V rated value | 2 kW |
| ● at 690 V rated value | 2.5 kW |
| operating apparent power at AC-6a | |
| ● up to 230 V for current peak value n=20 rated value | 2 kVA |
| ● up to 400 V for current peak value n=20 rated value | 3.6 kVA |
| ● up to 500 V for current peak value n=20 rated value | 4.6 kVA |
| ● up to 690 V for current peak value n=20 rated value | 5.9 kVA |
| operating apparent power at AC-6a | |
| ● up to 230 V for current peak value n=30 rated value | 1.3 kVA |
| ● up to 400 V for current peak value n=30 rated value | 2.4 kVA |
| ● up to 500 V for current peak value n=30 rated value | 3.1 kVA |
| ● up to 690 V for current peak value n=30 rated value | 4 kVA |
| short-time withstand current in cold operating state up to 40 °C | |
| ● limited to 1 s switching at zero current maximum | 155 A; Use minimum cross-section acc. to AC-1 rated value |
| ● limited to 5 s switching at zero current maximum | 111 A; Use minimum cross-section acc. to AC-1 rated value |
| ● limited to 10 s switching at zero current maximum | 86 A; Use minimum cross-section acc. to AC-1 rated value |
| ● limited to 30 s switching at zero current maximum | 66 A; Use minimum cross-section acc. to AC-1 rated value |
| ● limited to 60 s switching at zero current maximum | 55 A; Use minimum cross-section acc. to AC-1 rated value |
| no-load switching frequency | |
| ● at DC | 10 000 1/h |
| operating frequency | |
| ● at AC-1 maximum | 1 000 1/h |
| ● at AC-2 maximum | 750 1/h |
| ● at AC-3 maximum | 750 1/h |
| ● at AC-3e | |
| — maximum | 750 1/h |

| | |
|---|---|
| • at AC-4 maximum | 250 1/h |
| Control circuit/ Control | |
| type of voltage of the control supply voltage | DC |
| control supply voltage at DC rated value | 24 V |
| operating range factor control supply voltage rated value of magnet coil at DC | |
| • initial value | 0.85 |
| • full-scale value | 1.85 |
| design of the surge suppressor | with varistor |
| closing power of magnet coil at DC | 1.6 W |
| holding power of magnet coil at DC | 1.6 W |
| closing delay | |
| • at DC | 25 ... 120 ms |
| opening delay | |
| • at DC | 5 ... 20 ms |
| arcing time | 10 ... 15 ms |
| control version of the switch operating mechanism | Standard A1 - A2 |
| Auxiliary circuit | |
| number of NC contacts for auxiliary contacts instantaneous contact | 0 |
| number of NO contacts for auxiliary contacts instantaneous contact | 1 |
| operational current at AC-12 maximum | 10 A |
| operational current at AC-15 | |
| • at 230 V rated value | 10 A |
| • at 400 V rated value | 3 A |
| • at 500 V rated value | 2 A |
| • at 690 V rated value | 1 A |
| operational current at DC-12 | |
| • at 24 V rated value | 10 A |
| • at 48 V rated value | 6 A |
| • at 60 V rated value | 6 A |
| • at 110 V rated value | 3 A |
| • at 125 V rated value | 2 A |
| • at 220 V rated value | 1 A |
| • at 600 V rated value | 0.15 A |
| operational current at DC-13 | |
| • at 24 V rated value | 10 A |
| • at 48 V rated value | 2 A |
| • at 60 V rated value | 2 A |
| • at 110 V rated value | 1 A |
| • at 125 V rated value | 0.9 A |
| • at 220 V rated value | 0.3 A |
| • at 600 V rated value | 0.1 A |
| contact reliability of auxiliary contacts | 1 faulty switching per 100 million (17 V, 1 mA) |
| UL/CSA ratings | |
| full-load current (FLA) for 3-phase AC motor | |
| • at 480 V rated value | 7.6 A |
| • at 600 V rated value | 9 A |
| yielded mechanical performance [hp] | |
| • for single-phase AC motor | |
| — at 110/120 V rated value | 0.33 hp |
| — at 230 V rated value | 1 hp |
| • for 3-phase AC motor | |
| — at 200/208 V rated value | 2 hp |
| — at 220/230 V rated value | 3 hp |
| — at 460/480 V rated value | 5 hp |
| — at 575/600 V rated value | 7.5 hp |
| contact rating of auxiliary contacts according to UL | A600 / Q600 |

| Short-circuit protection | |
|---|--|
| design of the miniature circuit breaker for short-circuit protection of the auxiliary circuit up to 230 V | C characteristic: 10 A; 0.4 kA |
| design of the fuse link <ul style="list-style-type: none"> • for short-circuit protection of the main circuit <ul style="list-style-type: none"> — with type of coordination 1 required — with type of coordination 2 required • for short-circuit protection of the auxiliary switch required | gG: 35 A (690 V, 100 kA), aM: 20 A (690 V, 100 kA), BS88: 35 A (415 V, 80 kA) gG: 20 A (690 V, 100 kA), aM: 16 A (690 V, 100 kA), BS88: 20 A (415 V, 80 kA) gG: 10 A (500 V, 1 kA) |
| Installation/ mounting/ dimensions | |
| mounting position | +/-180° rotation possible on vertical mounting surface; can be tilted forward and backward by +/- 22.5° on vertical mounting surface |
| fastening method side-by-side mounting | Yes |
| fastening method | screw and snap-on mounting onto 35 mm DIN rail according to DIN EN 60715 |
| height | 70 mm |
| width | 45 mm |
| depth | 121 mm |
| required spacing <ul style="list-style-type: none"> • with side-by-side mounting <ul style="list-style-type: none"> — forwards — upwards — downwards — at the side • for grounded parts <ul style="list-style-type: none"> — forwards — upwards — at the side — downwards • for live parts <ul style="list-style-type: none"> — forwards — upwards — downwards — at the side | 10 mm 10 mm 10 mm 0 mm 10 mm 10 mm 6 mm 10 mm 10 mm 10 mm 10 mm 6 mm |
| Connections/ Terminals | |
| type of electrical connection <ul style="list-style-type: none"> • for main current circuit • for auxiliary and control circuit • at contactor for auxiliary contacts • of magnet coil | spring-loaded terminals spring-loaded terminals Spring-type terminals Spring-type terminals |
| type of connectable conductor cross-sections <ul style="list-style-type: none"> • for main contacts <ul style="list-style-type: none"> — solid — solid or stranded — finely stranded with core end processing — finely stranded without core end processing • for AWG cables for main contacts | 2x (0.5 ... 4 mm ²) 2x (0.5 ... 4 mm ²) 2x (0.5 ... 2.5 mm ²) 2x (0.5 ... 2.5 mm ²) 2x (20 ... 12) |
| connectable conductor cross-section for main contacts <ul style="list-style-type: none"> • solid • stranded • finely stranded with core end processing • finely stranded without core end processing | 0.5 ... 4 mm ² 0.5 ... 4 mm ² 0.5 ... 2.5 mm ² 0.5 ... 2.5 mm ² |
| connectable conductor cross-section for auxiliary contacts <ul style="list-style-type: none"> • solid or stranded • finely stranded with core end processing • finely stranded without core end processing | 0.5 ... 4 mm ² 0.5 ... 2.5 mm ² 0.5 ... 2.5 mm ² |
| type of connectable conductor cross-sections <ul style="list-style-type: none"> • for auxiliary contacts <ul style="list-style-type: none"> — solid or stranded — finely stranded with core end processing — finely stranded without core end processing | 2x (0.5 ... 4 mm ²) 2x (0.5 ... 2.5 mm ²) 2x (0.5 ... 2.5 mm ²) |

| | |
|---|----------------|
| • for AWG cables for auxiliary contacts | 2x (20 ... 12) |
| AWG number as coded connectable conductor cross section for main contacts | 20 ... 12 |
| AWG number as coded connectable conductor cross section for auxiliary contacts | 20 ... 12 |

Safety related data



| | |
|--|--|
| product function | |
| • mirror contact according to IEC 60947-4-1 | No |
| • positively driven operation according to IEC 60947-5-1 | No |
| • suitable for safety function | Yes |
| suitability for use safety-related switching OFF | Yes |
| service life maximum | 20 a |
| test wear-related service life necessary | Yes |
| proportion of dangerous failures | |
| • with low demand rate according to SN 31920 | 40 % |
| • with high demand rate according to SN 31920 | 73 % |
| B10 value with high demand rate according to SN 31920 | 1 000 000 |
| failure rate [FIT] with low demand rate according to SN 31920 | 100 FIT |
| ISO 13849 | |
| device type according to ISO 13849-1 | 3 |
| overdimensioning according to ISO 13849-2 necessary | Yes |
| IEC 61508 | |
| safety device type according to IEC 61508-2 | Type A |
| Electrical Safety | |
| protection class IP on the front according to IEC 60529 | IP20 |
| touch protection on the front according to IEC 60529 | finger-safe, for vertical contact from the front |

Approvals Certificates

| | |
|--|-----------|
| Environmental Product Declaration | |
| • global warming potential [CO2 eq] / during manufacturing | 1.42 kg |
| • global warming potential [CO2 eq] / during operation | 152 kg |
| • global warming potential [CO2 eq] / after end of life | -0.305 kg |
| • global warming potential [CO2 eq] / total | 153 kg |

Environment General Product Approval

[Environmental Confirmations](#)



General Product Approval EMV Test Certificates







[Special Test Certificate](#)

Test Certificates Maritime application



[Type Test Certificates/Test Report](#)







Maritime application other

[Miscellaneous](#) [Confirmation](#) [Miscellaneous](#)



[Special Test Certificate](#)

Further information

Information on the packaging

<https://support.industry.siemens.com/cs/ww/en/view/109813875>

Information for data generation and storage

<https://support.industry.siemens.com/cs/ww/en/view/109995012>

Information- and Downloadcenter (Catalogs, Brochures,...)

<https://www.siemens.com/ic10>

Industry Mall (Online ordering system)

<https://mall.industry.siemens.com/mall/en/en/Catalog/product?mlfb=3RT2016-2WB41>

Service&Support (Manuals, Certificates, Characteristics, FAQs,...)

<https://support.industry.siemens.com/cs/ww/en/ps/3RT2016-2WB41>

Image database (product images, 2D dimension drawings, 3D models, device circuit diagrams, EPLAN macros, ...)

https://www.automation.siemens.com/bilddb/cax_de.aspx?mlfb=3RT2016-2WB41&lang=en

Cax online generator

<https://support.automation.siemens.com/WW/CAxorder/default.aspx?lang=en&mlfb=3RT2016-2WB41>

Characteristic curves

[https://curves.simaris.siemens.com/curves/<mmp_prod_noCOMP="HAUPT"></mmp_prod_no>](https://curves.simaris.siemens.com/curves/<mmp_prod_noCOMP=)

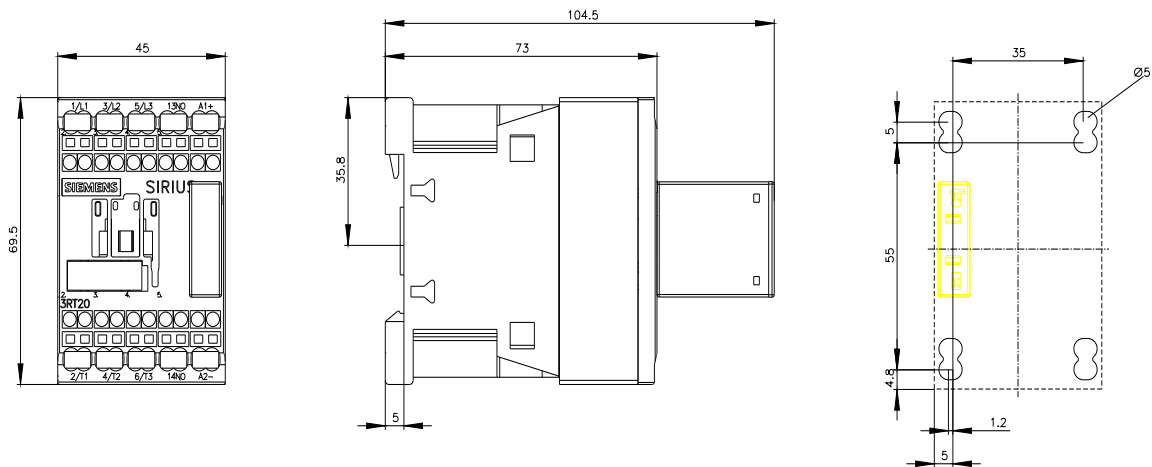

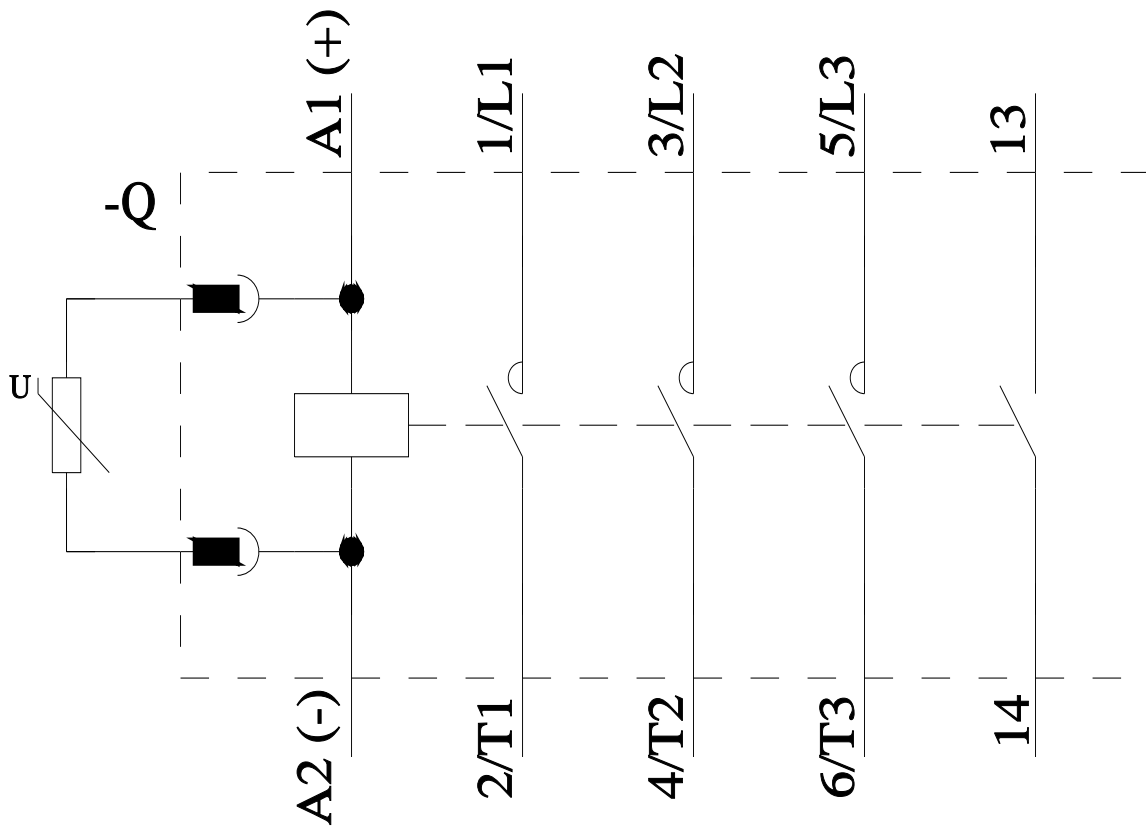
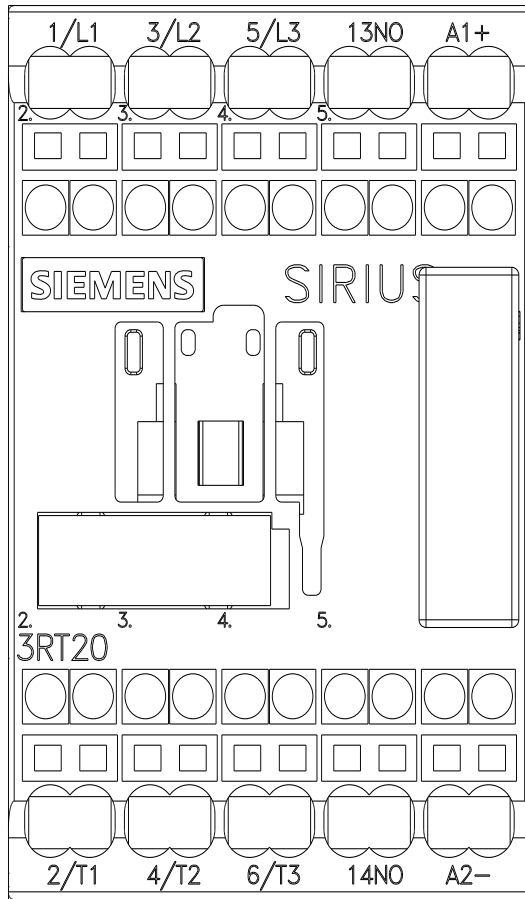

last modified:

4/4/2026