

Product datasheet

Specifications



SH3 servomotor, 100mm, 3 stacks, smooth Shaft, Multiturn DSL 18bit, no Brake, OneMotorCable angular M23, IP65/65

SH31003P0BA4100

Disclaimer: This documentation is not intended as a substitute for and is not to be used for determining suitability or reliability of these products for specific user applications



Environmental Data

Schneider Electric aims to achieve Net Zero status by 2050 through supply chain partnerships, lower impact materials, and circularity via our ongoing “Use Better, Use Longer, Use Again” campaign to extend product lifetimes and recyclability.

[Environmental Data explained >](#)

[How we assess product sustainability >](#)

Use Longer



Lifetime extension

Repair

No

Dimensions Drawings

Dimensions

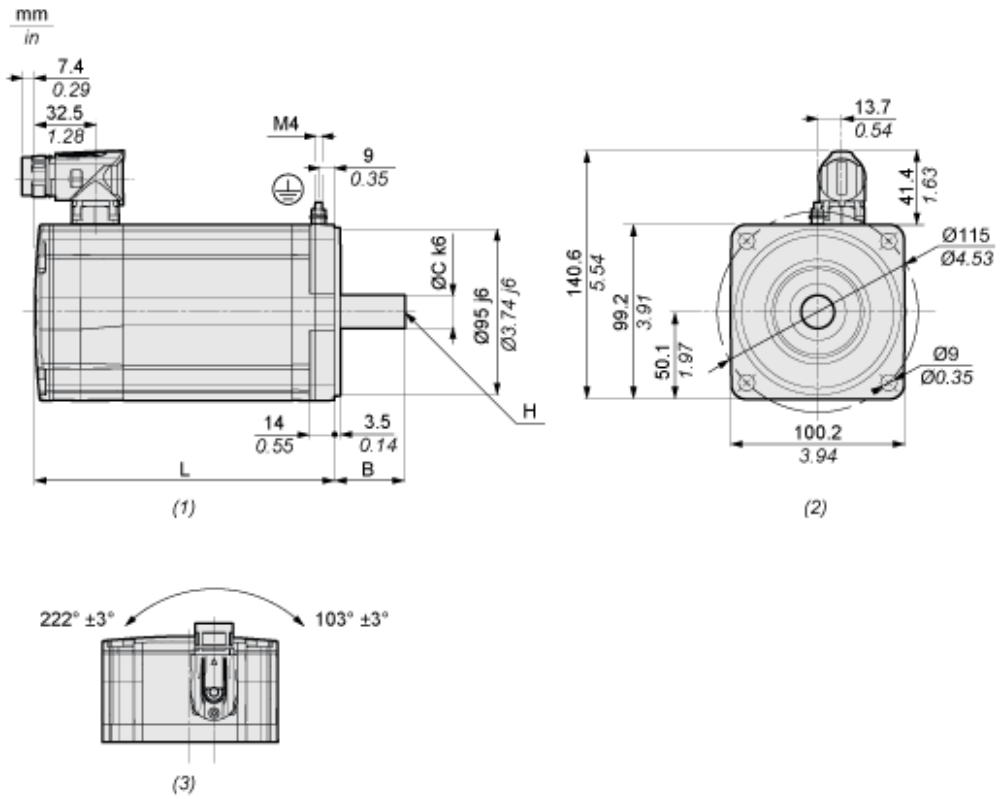

- (1) : Side view
- (2) : Mounting
- (3) : Rotating area

Characteristic	Unit	Value
L	Length without holding brake	mm (in) 240.5 (9.47)
B	Shaft length	mm (in) 40 (1.57)
C	Shaft diameter	mm (in) 19 (0.75)
H	Female thread of shaft	DIN 332-D M6