

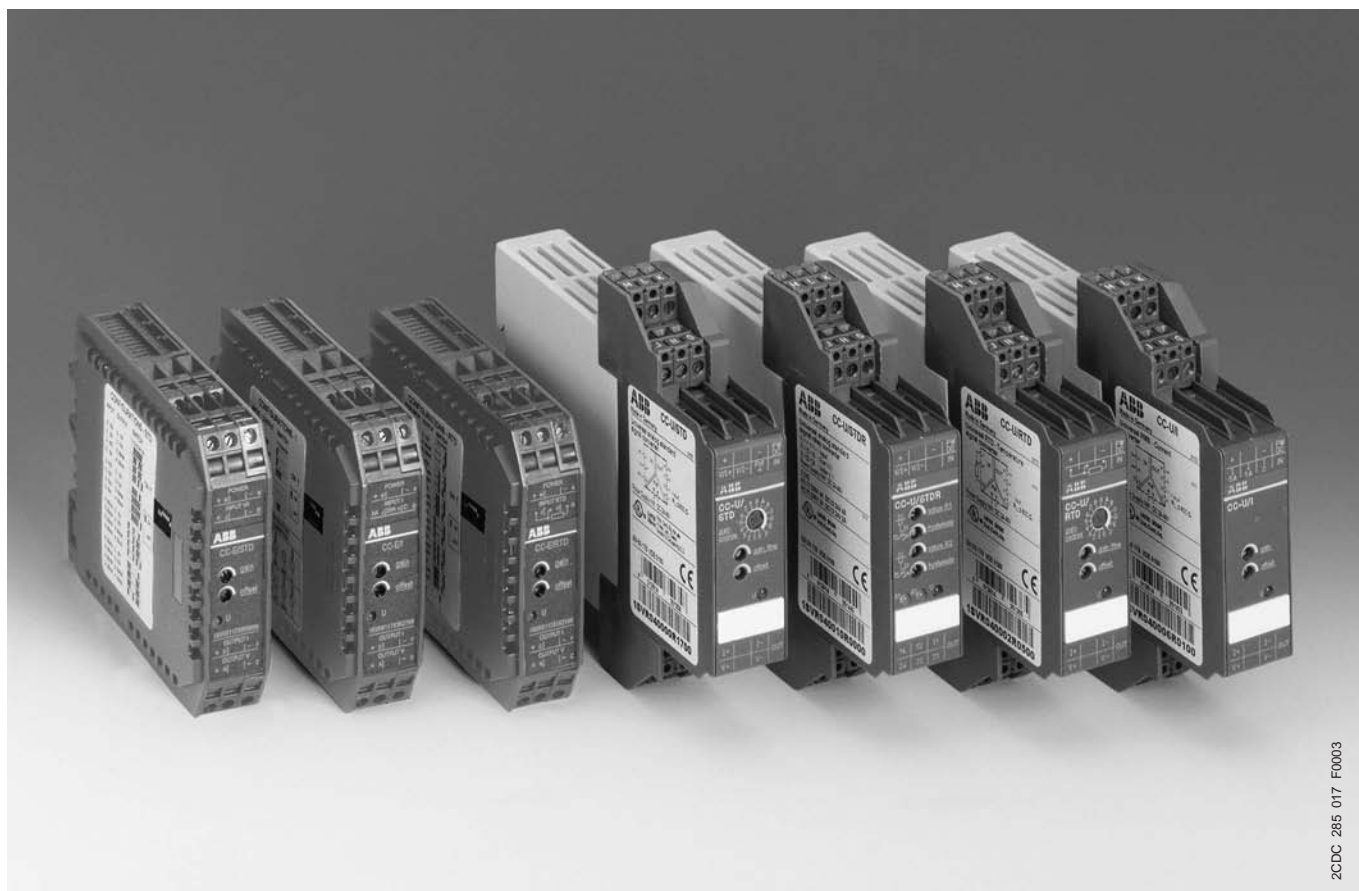

Content

Benefits and advantages of analog signal converters	160
Application	162
Approvals and marks	162
Analog standard signal converters CC-E/STD, CC-E x/x, CC-E I/I, CC-U/STD, CC-U/STDR	
Ordering details	163
Technical data	177
Dimensional drawings	183
Temperature signal converters for RTD sensors CC-E/RTD, CC-U/RTD, CC-U/RTDR	
Ordering details	167
Technical data	177
Dimensional drawings	183
Temperature signal converters for thermocouples CC-E/TC, CC-U/TC, CC-U/TCR	
Ordering details	170
Technical data	177
Dimensional drawings	183
Measuring converters for currents (E/I) and (U/I) and voltages (U/V) CC-E/I, CC-E I_{AC} / ILPO, CC-U/I, CC-U/V	
Ordering details	173
Technical data	176
Dimensional drawings	183

Analog signal converters CC range Benefits and advantages



2CDC 285 017 F0003

5

CC-E product range for analog signal processing

- **Universally configurable devices and single-function devices**
- **Adjustment and operating elements on the front side**
- **Safe operation by electrical 3-way isolation**
- **Unambiguous and clear connecting terminal markings**

Conversion, measurement and separation of

- standard signals (0-5 V, 0-10 V, 0-20 mA, 4-20 mA)
- temperature signals of RTD sensors (PT 100)
- thermocouple signals (types J and K)
- current measurement signals (0-5 A, 0-20 A AC/DC)

Characteristics of single-function devices

- No adjustment or balancing necessary.

Characteristics of universal devices

- The required input and output ranges can be configured by means of directly accessible DIP switches positioned on the side
- Gain adjustment of $\pm 5\%$ by means of an adjustment potentiometer on the front-side
- Offset adjustment of $\pm 5\%$ by means of adjustment potentiometers on the front-side

Analog signal converters CC range Benefits and advantages

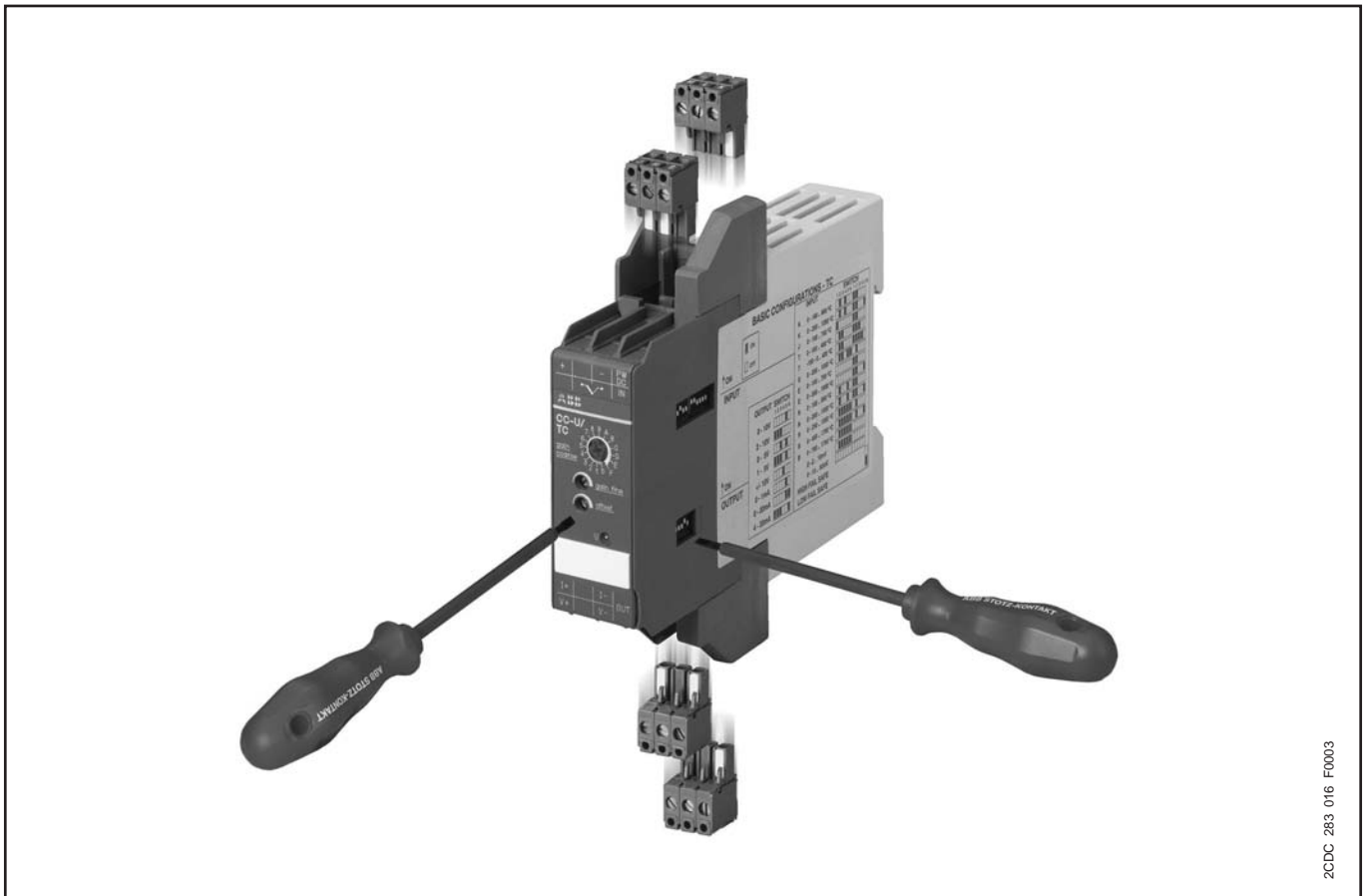

CC-U product range for analog signal processing

- 8 different standard signal outputs on one device
- Input and output side universally configurable
- Also available with 2 threshold relay outputs
- Adjustment and operating elements on the front side
- Safe operation by electrical 3-way isolation
- Plug-in connecting terminals, unambiguously and clearly marked

Conversion, measurement and separation of

- standard signals
- signals of RTD sensors (PT10, PT100, PT1000)
- thermocouple signals
- RMS values of currents and voltages

Characteristics

- The required input and output ranges can be configured for all devices by means of directly accessible DIP switches positioned on the side.
- Due to the wide input range of the gain and offset stages all input signals between the minimum and the maximum input value can be universally converted to all common output signals.
- Devices for DC or AC (50/60 Hz) supply available.

Analog signal converters

CC range

Application, approvals

Applications for analog signal processing and correct solution using CC-E and CC-U converters

Nearly every process includes a control system that receives data by means of analog signals and then evaluates the data and sets the respective parameters correspondingly.

When transmitting analog signals numerous problems may arise which can disturb or even block an ideal behavior of the process.

Below we have listed some processing problems together with the respective solutions to solve these problems:

Signal conversion

Sometimes the available signals cannot be processed by the controller or the actuator. In this case, signal converters are required to convert the input signal (or different input signals) to the desired output signal.

Signal amplification

If long lines or high burdens have to be operated, it may be necessary to amplify the signal. CC analog signal converters require only low input power and provide high output power.

Thus, there are no restrictions for the converter's position on the line, i.e. it can be used

- for signal refreshing ① at the end of the line (low input power)
- or for signal amplification ② at the beginning of the line (high output power).

Signal filtering

Particularly on long lines or in rough industrial environments the signals are exposed to high electromagnetic interferences. The frequency of the coupled interference signals may be in the range of the common mains frequency (50 Hz) or even much higher (in case of frequency converters). According to the specific requirements, analog signal converters are available which provide reliable suppression of those interferences by means of an input low-pass filter.

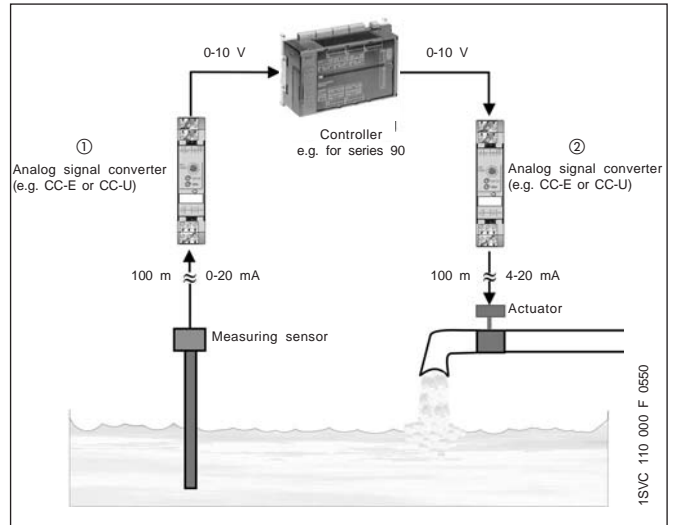

Signal separation

- **Protection against overvoltage**
The increased use of micro-electronics make controls much more sensitive against overvoltages, resulting from lightning discharges or switching processes. Suppression diodes are incorporated in the input of the CC analog signal converters which enable the converters to arrest overvoltages with low energy level (resulting from switching processes) by themselves. The products furthermore provide electrical isolation between input, output and supply circuit for protection of the controller connected to the output.
- **Protection against ground loops**
If components are used which refer to ground, the measuring signals can be falsified by a so-called ground loop. In this case, certain parts of the signal are transmitted via earth and not via the analog transmission line, thus causing incorrect evaluation of the signal. The electrical isolation between the input and the output disconnects these ground loops and thus enables correct signal transmission.

- all devices
- specific devices
- pending

Approvals

	CC-E/STD	CC-E /I	CC-U/STD	CC-U/STDR	CC-E/RTD	CC-U/RTD	CC-U/RTDR	CC-E/TC	CC-U/TC	CC-U/TCR	CC-E/I	CC-E I _{AC} /ILPO	CC-U/I	CC-U/V			
UL 508	■	■	■	■	■	■	■	■	■	■	■	■	■	■			
1604 Class 1, Div. 2 (hazardous locations)	■		■		■	■		■			■		■	■			
	□	□	□	□	□	□	□	□	□	□	□	□	□	□			

Marks

	■	■	■	■	■	■	■	■	■	■	■	■	■	■			
C-Tick	■	■	■	■	■	■	■	■	■	■	■	■	■	■			

Analog standard signal converters

CC-E/STD, CC-E x/x

Ordering details

2CDC 281 001 F 0003



CC-E/STD

- ① Gain adjustment
- ② Offset adjustment
- ③ U: green LED - supply voltage
- ④ DIP switch for input and output configuration (only available on universal devices)

CC-E/STD analog signal converter with 3-way electrical isolation

- Universally configurable device (type E-STD)
- 10 single-function devices
- "Plug and Play", no adjustment of single-function devices required

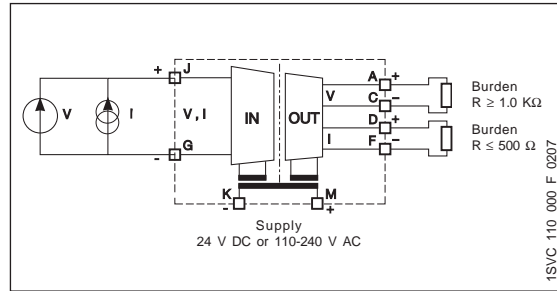

DIP switch settings for CC-E/STD (universal)

Input	Output	Switch							
		1	2	3	4	5	6	7	8
0...5V	0...5V								
0...5V	0...10V								
0...5V	0...20mA								
0...5V	4...20mA								
0...10V	0...5V								
0...10V	0...10V								
0...10V	0...20mA								
0...10V	4...20mA								
0...20mA	0...5V								
0...20mA	0...10V								
0...20mA	0...20mA								
0...20mA	4...20mA								
4...20mA	0...5V								
4...20mA	0...10V								
4...20mA	0...20mA								
4...20mA	4...20mA								

Legend: ON, OFF

Type	Input signal	Output signal	Order code	Price 1 piece
------	--------------	---------------	------------	---------------

Supply voltage: 24 V DC
universal

CC-E/STD	0-5 V, 0-10 V 0-20 mA, 4-20 mA	0-5 V, 0-10 V 0-20 mA, 4-20 mA	1SVR 011 700 R0000 ¹⁾	
----------	-----------------------------------	-----------------------------------	----------------------------------	--

single-function

CC-E V/V		0-10 V	1SVR 011 710 R2100	
CC-E V/I	0-10 V	0-20 mA	1SVR 011 711 R1600	
CC-E V/I		4-20 mA	1SVR 011 712 R1700	
CC-E I/V		0-10 V	1SVR 011 713 R1000	
CC-E I/I	0-20 mA	0-20 mA	1SVR 011 714 R1100	
CC-E I/I		4-20 mA	1SVR 011 715 R1200	
CC-E I/V		0-10 V	1SVR 011 716 R1300	
CC-E I/I	4-20 mA	0-20 mA	1SVR 011 717 R1400	
CC-E I/I		4-20 mA	1SVR 011 718 R2500	
CC-E V/V	-10...+10 V	-10...+10 V	1SVR 011 719 R2600	

Supply voltage: 110-240 V AC
universal

CC-E/STD	0-5 V, 0-10 V 0-20 mA, 4-20 mA	0-5 V, 0-10 V 0-20 mA, 4-20 mA	1SVR 011 705 R2100	
----------	-----------------------------------	-----------------------------------	--------------------	--

single-function

CC-E V/V		0-10 V	1SVR 011 720 R2300	
CC-E V/I	0-10 V	0-20 mA	1SVR 011 721 R1000	
CC-E V/I		4-20 mA	1SVR 011 722 R1100	
CC-E I/V		0-10 V	1SVR 011 723 R1200	
CC-E I/I	0-20 mA	0-20 mA	1SVR 011 724 R1300	
CC-E I/I		4-20 mA	1SVR 011 725 R1400	
CC-E I/V		0-10 V	1SVR 011 726 R1500	
CC-E I/I	4-20 mA	0-20 mA	1SVR 011 727 R1600	
CC-E I/I		4-20 mA	1SVR 011 728 R2700	
CC-E V/V	-10...+10 V	-10...+10 V	1SVR 011 729 R2000	

¹⁾ UL 1604 Class I, Div.2
(universal devices)

Pack. units: 1 piece

• Technical data 177 • Dimensional drawings 183

NEW

Current / current isolator CC-E I/I Ordering details



2CDC281040 F0003

CC-E I/I-1



2CDC281041 F0003

CC-E I/I-2

Loop-powered I/I isolator without external power supply for analog current signals of 0-20 mA and 4-20 mA

- Electrical isolation between input and output
- Very low internal voltage drop ≤ 2.5 V
- Available with one or two independent channels
- Width only 18 mm (1 and 2 channels)

Wiring instruction

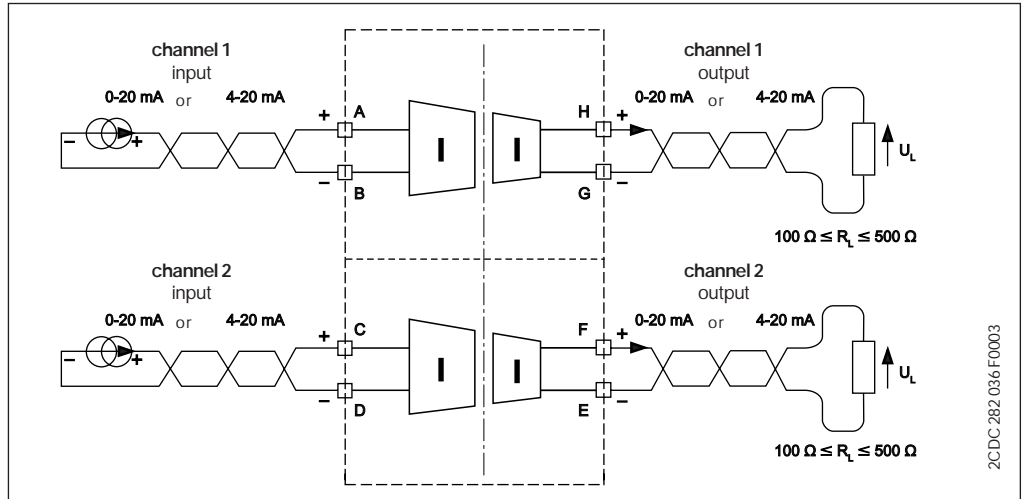

2CDC282036 F0003

Type	Number of channels	Order code	Price 1 piece
CC-E I/I-1	1 channel	1SVR 010 200 R1600	
CC-E I/I-2	2 channel	1SVR 010 201 R0300	

Packing unit: 1 piece

• Technical data 179 • Dimensional drawings 183

Analog standard signal converter CC-U/STD

Ordering details

2CDC 281 002 F0003

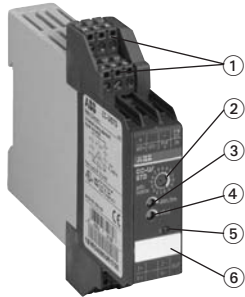

CC-U/STD

- ① Plug-in terminals
- ② Gain: Coarse adjustment
- ③ Gain: Fine adjustment
- ④ Offset adjustment
- ⑤ U: green LED - supply voltage
- ⑥ Marker

CC-U/STD universal signal converter with 3-way electrical isolation

- More than 120 configurations possible
- Configurable output signal response on input signal interruption (low fail safe / high fail safe)
- Adjustment and operating elements on the front-side
- Short-circuit proof signal outputs
- Plug-in connecting terminals for inputs, outputs and supply
- Very fast signal transmission enables use in control systems

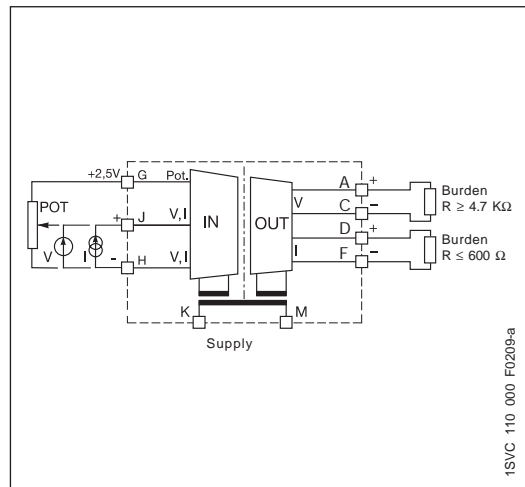

1SVK 110 000 F0209-a

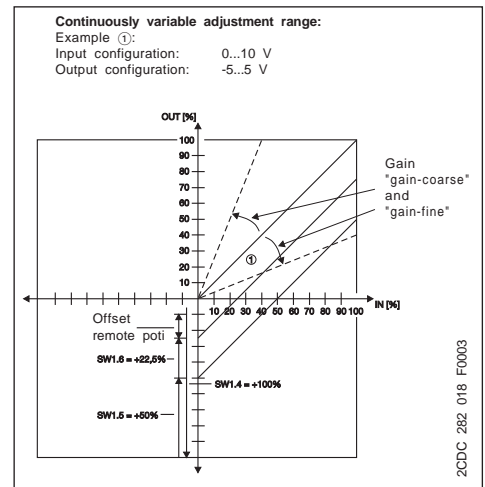

2CDC 282 018 F0003

DIP switch settings

Input	SW1								Gain	Coarse Type
	1	2	3	4	5	6	7	8		
Potentiometer									A...D	C
0...50 mV									A...D	C
0...100 mV									4...5	5
0...250 mV									0...1	1
0...500 mV									7...9	8
0...1 V									3...4	3
0...2.5 V									0	0
0...5 V									5...7	6
0...10 V									2	2
1...5 V									7...9	8
2...10 V									2...4	3
-10...+10 V									0	0
0...125 mV									3...4	3
0...8 V									3...4	3
-22.5...+22.5 mV									B...F	D
-11...+11 V									0	0
2.5...7.5 V									5...7	6
3.33...9.99 V									3...4	4
10...0 V									2	2
100...0 mV									4...5	5
0...1 mA									A...D	B
0...20 mA									2...4	3
4...20 mA									4...5	4
10...50 mA									0...1	1
20...4 mA									4...5	4
20...0 mA									4...2	3
-0.45...+0.45 mA									B...F	D
-55...+55 mA									4...6	5
High fail safe *)									-	-
Low fail safe *)									-	-
No fail safe *)									-	-

*) Detection of input signal interruptions:

If the input signal circuit is interrupted, the output signal changes to the adjusted minimum value (low fail safe) or maximum value (high fail safe). If "No fail safe" is configured, input signal interruptions are not detected.

2CDC 282 019 F0003

Output	SW2					
	1	2	3	4	5	6
0...5 V						
0...10 V						
1...5 V						
2...10 V						
-10...+10 V						
-5...+5 V						
-10...0 V						
-5...0 V						
0...6.66 V						
-10...3.33 V						
-5...1.66 V						
0...8 V						
0...4 V						
-10...-2 V						
-5...-1 V						
1.25...6.25 V						
-7.5...-2.5 V						
-3.75...1.25 V						
1.66...8.33 V						
-6.66...-6.66 V						
-3.33...-3.33 V						
-8...0 V						
-4...0 V						
0...1 mA						
0...20 mA						
4...20 mA						
0...10 mA						
0...0.5 mA						
0...13.33 mA						
0...666 µA						
0...16 mA						
0...800 µA						
0...8 mA						
0...400 µA						
2.5...12.5 mA						
125...625 µA						
3.33...16.66 mA						
166...833 µA						
0.2...1 mA						
2...10 mA						
100...500 µA						

2CDC 282 020 F0003

Legend	
■	ON
□	OFF
■	no influence

2CDC 282 003 F0004

Type	Supply voltage 50/60 Hz	Order code	Pack. unit pieces	Price 1 piece
CC-U/STD	24-48 V DC / 24 V AC 110-240 V AC / 100-300 V DC	1SVR 040 000 R1700	1	
		1SVR 040 001 R0400	1	

• Technical data 180 • Dimensional drawings 183

Analog standard signal converter CC-U/STDR with relay output Ordering details

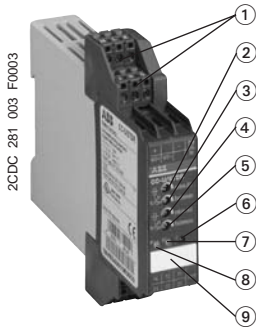

CC-U/STDR

- ① Plug-in connecting terminals
- ② Threshold value for R1
- ③ Hysteresis for R1
- ④ Threshold value for R2
- ⑤ Hysteresis for R2
- ⑥ U: green LED - supply voltage
- ⑦ R2: yellow LED - Relay 2 energized
- ⑧ R1: yellow LED - Relay 1 energized
- ⑨ Marker

CC-U/STDR universal signal converter for standard signals, with 2 threshold relay outputs and with 3-way electrical isolation

- Standard signal converter with 7 setting ranges
- 2 threshold relay outputs with one c/o contact each (threshold and respective hysteresis can be adjusted independently from each other)
- Open-circuit or closed-circuit principle configurable by means of a DIP switch
- 2 yellow LEDs for clear status indication of the output relays
- Plug-in connecting terminals for inputs, outputs and supply

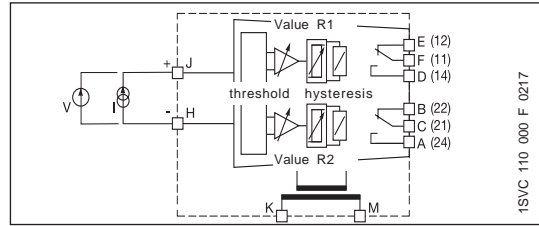

DIP switch settings

Input	SW1					
	1	2	3	4	5	6
0 ... 10 V						
0 ... 5 V	■					
0 ... 1 V		■				
-10 ... +10 V			■			
1 ... 5 V				■		
0 ... 20 mA					■	
4 ... 20 mA						■
Closed-circuit principle	■	■	■	■	■	■
Open-circuit principle	■	■	■	■	■	■

Legend:
 ■ ON
 □ OFF
 ■ no influence

Function diagrams CC-U/STDR

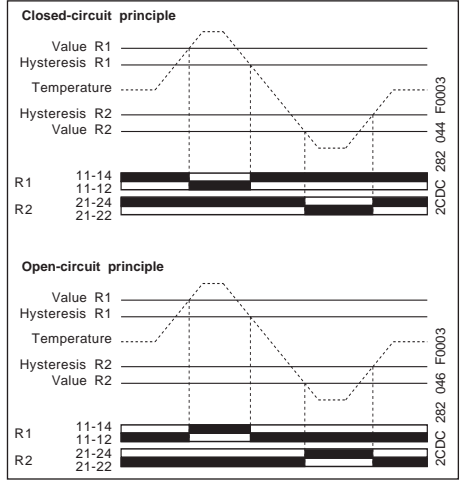

Switching points of the output relay depending on the input range, configuration open-circuit principle

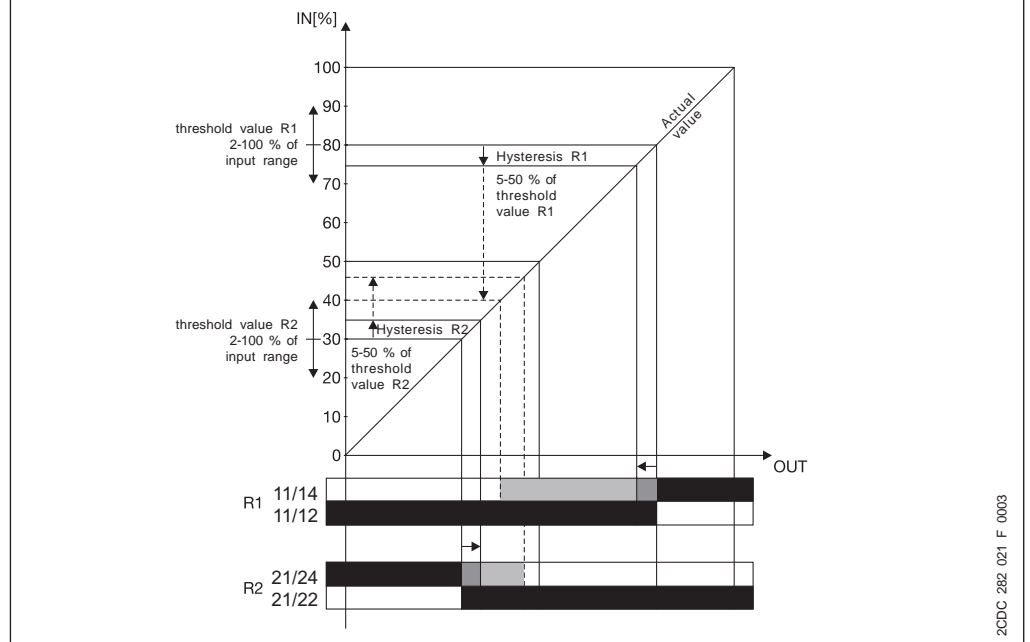

Type	Supply voltage 50/60 Hz	Order code	Pack. unit pieces	Price 1 piece
CC-U/STDR	24-48 V DC / 24 V AC	1SVR 040 010 R0000	1	
	110-240 V AC / 100-300 V DC	1SVR 040 011 R2500	1	

• Technical data 182 • Dimensional drawings 183

Temperature signal converter for RTD sensors CC-E/RTD Ordering details

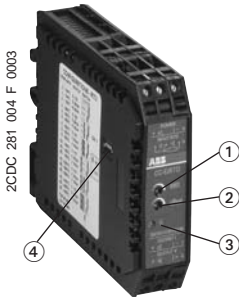

CC-E/RTD

- ① Gain adjustment
- ② Offset adjustment
- ③ U: green LED - supply voltage
- ④ DIP switch for input and output configuration (only available on universal devices)

CC-E/RTD temperature signal converter for RTD sensors, linearized with 3-way electrical isolation

- Universally configurable device (type E-RTD)
- 12 single-function devices
- "Plug and Play", no adjustment of single-function devices required
- Temperature signal converter for PT100 sensors
- 2- or 3-wire connection

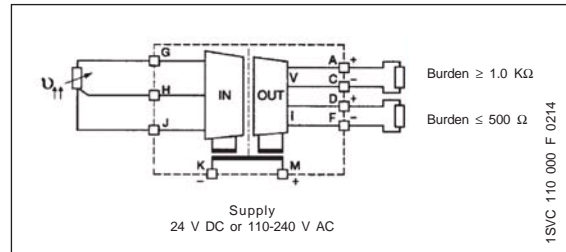

Input	Output	SW 1					
		1	2	3	4	5	6
0 - 100°C	0 - 10 V						
0 - 100°C	0 - 20 mA						
0 - 100°C	4 - 20 mA						
0 - 300°C	0 - 10 V						
0 - 300°C	0 - 20 mA						
0 - 300°C	4 - 20 mA						
0 - 500°C	0 - 10 V						
0 - 500°C	0 - 20 mA						
0 - 500°C	4 - 20 mA						
-50 - 50°C	0 - 10 V						
-50 - 50°C	0 - 20 mA						
-50 - 50°C	4 - 20 mA						
-50 - 250°C	0 - 10 V						
-50 - 250°C	0 - 20 mA						
-50 - 250°C	4 - 20 mA						
-50 - 250°C	0 - 10 V						
-50 - 250°C	0 - 20 mA						
-50 - 250°C	4 - 20 mA						
High lead rate							
Low lead rate							

Type	Input signal	Output signal	Order code	Price 1 piece
------	--------------	---------------	------------	---------------

Supply voltage: 24 V DC universal

CC-E/RTD	refer to table	0-10 V, 0-20 mA, 4-20 mA	1SVR 011 701 R2500 ¹⁾	
single-function				
CC-E RTD/V		0-10 V	1SVR 011 730 R2500	
CC-E RTD/I	PT100 0...100 °C	0-20 mA	1SVR 011 731 R1200	
CC-E RTD/I		4-20 mA	1SVR 011 732 R1300	
CC-E RTD/V		0-10 V	1SVR 011 733 R1400	
CC-E RTD/I	PT100 -50...+50 °C	0-20 mA	1SVR 011 734 R1500	
CC-E RTD/I		4-20 mA	1SVR 011 735 R1600	
CC-E RTD/V		0-10 V	1SVR 011 736 R1700	
CC-E RTD/I	PT100 0...300 °C	0-20 mA	1SVR 011 737 R1000	
CC-E RTD/I		4-20 mA	1SVR 011 738 R2100	
CC-E RTD/V		0-10 V	1SVR 011 739 R2200	
CC-E RTD/I	PT100 -50...+250 °C	0-20 mA	1SVR 011 740 R0700	
CC-E RTD/I		4-20 mA	1SVR 011 741 R2400	

Supply voltage: 110-240 V AC universal

CC-E/RTD	refer to table	0-10 V, 0-20 mA, 4-20 mA	1SVR 011 706 R2200	
single-function				
CC-E RTD/V		0-10 V	1SVR 011 788 R2400	
CC-E RTD/I	PT100 0...100 °C	0-20 mA	1SVR 011 789 R2500	
CC-E RTD/I		4-20 mA	1SVR 011 790 R2200	
CC-E RTD/V		0-10 V	1SVR 011 791 R1700	
CC-E RTD/I	PT100 -50...+50 °C	0-20 mA	1SVR 011 792 R1000	
CC-E RTD/I		4-20 mA	1SVR 011 793 R1100	
CC-E RTD/V		0-10 V	1SVR 011 794 R1200	
CC-E RTD/I	PT100 0...300 °C	0-20 mA	1SVR 011 795 R1300	
CC-E RTD/I		4-20 mA	1SVR 011 796 R1400	
CC-E RTD/V		0-10 V	1SVR 011 797 R1500	
CC-E RTD/I	PT100 -50...+250 °C	0-20 mA	1SVR 011 798 R2600	
CC-E RTD/I		4-20 mA	1SVR 011 799 R2700	

Pack. units: 1 piece

• Technical data 177 • Dimensional drawings 183

¹⁾ UL 1604 Class I, Div.2 (universal devices)

Temperature signal converter for RTD sensors CC-U/RTD Ordering details

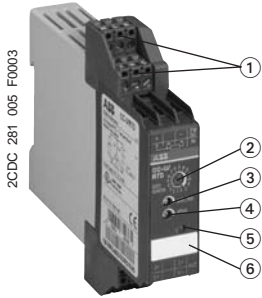

CC-U/RTD

- ① Plug-in connecting terminals
- ② Gain: Coarse adjustment
- ③ Gain: Fine adjustment
- ④ Offset adjustment
- ⑤ U: green LED - supply voltage
- ⑥ Marker

CC-U/RTD universal signal converter for PT10, PT100, PT1000 temperature sensors (acc. to IEC 751 and JIS C 1604*), linearized with 3-way electrical isolation

- Configurable output signal response on input signal interruption (low fail safe / high fail safe)
- Adjustment and operating elements on the front-side
- Short-circuit proof signal outputs
- Plug-in connecting terminals for inputs, outputs and supply

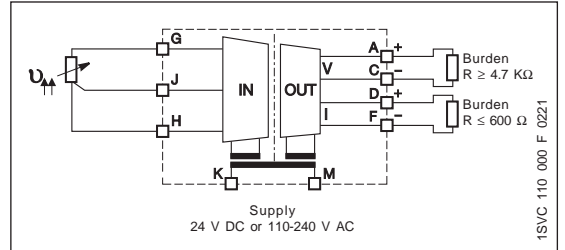

) Japanese standard

Characteristic curves: Resistance of PT10, PT100 and PT1000 sensors depending on the temperature

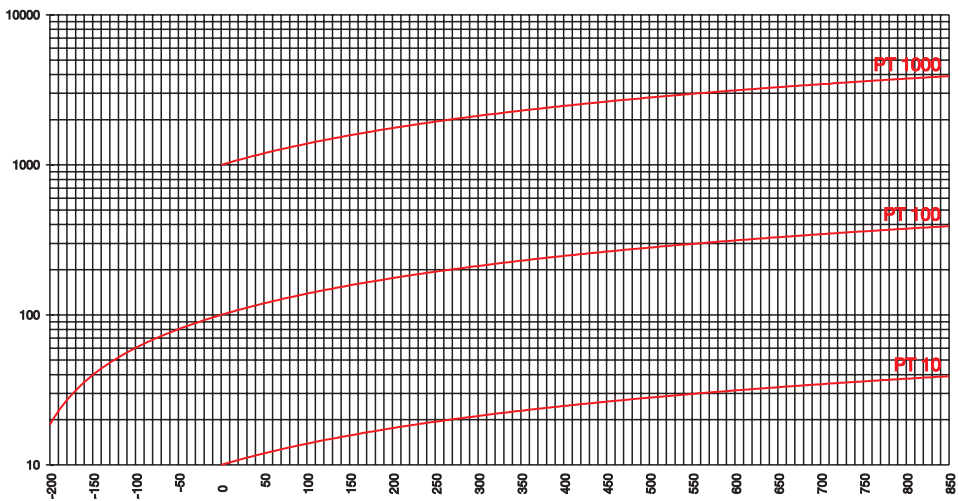

Input	SW1						SW2						Gain coarse
	1	2	3	4	5	6	1	2	3	4	5	6	
PT 10	0...500°C	■						■	■	■	■	■	F
	0...550°C	■						■	■	■	■	■	E
	0...600°C	■						■	■	■	■	■	D
	0...650°C	■						■	■	■	■	■	C
	0...700°C	■						■	■	■	■	■	B
	0...750°C	■						■	■	■	■	■	A
PT 100	0...800°C	■						■	■	■	■	■	9
	0...850°C	■						■	■	■	■	■	8
	0...90°C	■						■	■	■	■	■	F
	0...60°C	■						■	■	■	■	■	E
	0...70°C	■						■	■	■	■	■	B
	0...80°C	■						■	■	■	■	■	A
PT 1000	0...100°C	■						■	■	■	■	■	9
	0...200°C	■						■	■	■	■	■	8
	0...300°C	■						■	■	■	■	■	3
	0...400°C	■						■	■	■	■	■	2
	0...500°C	■						■	■	■	■	■	1
	0...10°C	■						■	■	■	■	■	8
0...20°C	■						■	■	■	■	■	3	
0...30°C	■						■	■	■	■	■	2	
0...40°C	■						■	■	■	■	■	1	
0...50°C	■						■	■	■	■	■	0	
0...60°C	■						■	■	■	■	■	0	
0...6°C	■						■	■	■	■	■	F	
Low fail safe*)	■						■	■	■	■	■	-	
High fail safe*)	■						■	■	■	■	■	-	

*) Detection of input signal interruptions:
If the input signal circuit is interrupted, the output signal changes to the adjusted minimum value (low fail safe) or maximum value (high fail safe).

Output	SW3					
	1	2	3	4	5	6
0...5 V						
0...10 V						
1...5 V	■					
2...10 V	■					
-10...+10 V						
-5...+5 V						
-10...0 V						
-5...0 V						
0...6.66 V						
-10...3.33 V						
-5...1.66 V						
0...8 V						
0...4 V						
-10...-2 V						
-5...-1 V						
1.25...6.25 V						
-7.5...-2.5 V						
-3.75...-1.25 V						
1.66...8.33 V						
-6.66...-6.66 V						
-3.33...-3.33 V						
-8...0 V						
-4...0 V						
0...1 mA						
0...20 mA						
4...20 mA						
0...10 mA						
0...0.5 mA						
0...13.33 mA						
0...666 µA						
0...16 mA						
0...800 µA						
0...8 mA						
0...400 µA						
2.5...12.5 mA						
125...625 µA						
3.33...16.65 mA						
166...833 µA						
0.2...1 mA						
2...10 mA						
100...500 µA						

Legend	
■	ON
□	OFF
■	no influence

Type	Supply voltage 50/60 Hz	Order code	Pack. unit pieces	Price 1 piece
CC-U/RTD	24-48 V DC / 24 V AC 110-240 V AC / 100-300 V DC	1SVR 040 002 R0500 1SVR 040 003 R0600	1 1	

• Technical data 180 • Dimensional drawings 183

Temperature signal converter for RTD sensors CC-U/RTDR with relay output Ordering details

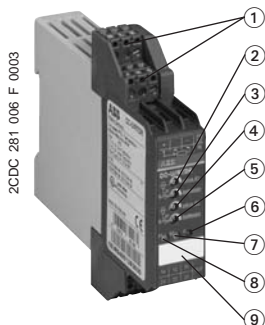

CC-U/RTDR

- ① Plug-in connecting terminals
- ② Threshold value for R1
- ③ Hysteresis for R1
- ④ Threshold value for R2
- ⑤ Hysteresis for R2
- ⑥ U: green LED - supply voltage
- ⑦ R2: yellow LED - Relay 2 energized
- ⑧ R1: yellow LED - Relay 1 energized
- ⑨ Marker

CC-U/RTDR universal signal converter for temperature and resistance signals, with 2 threshold relay outputs and 3-way electrical isolation

- Temperature signal converter for PT100 signals (5 ranges up to 800 °C) and variable resistances from 0-380 Ω
- 2 threshold relay outputs with one c/o contact each (threshold and respective hysteresis can be adjusted independently from each other)
- Open-circuit or closed-circuit principle configurable by means of a DIP switch
- 2 yellow LEDs for clear status indication of the output relays
- Plug-in connecting terminals for inputs, outputs and supply

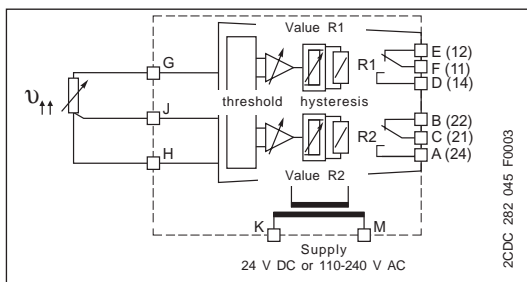

DIP switch settings

Input PT100	SW1					
	1	2	3	4	5	6
0...100 °C	■	■				
0...200 °C	■		■			
0...400 °C			■	■		
0...600 °C				■	■	
0...800 °C					■	■
Closed-circuit principle	■					
Open-circuit principle	■					

Legend	
■	ON
□	OFF
■	no influence

Function diagrams CC-U/RTDR

Closed-circuit principle

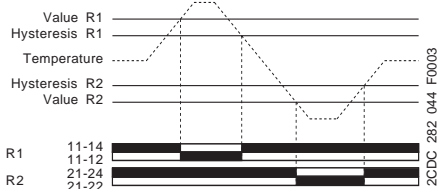

Open-circuit principle

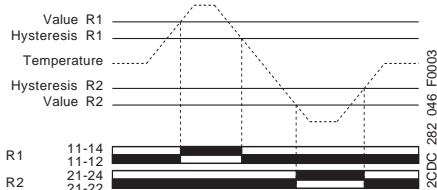

Switching points of the output relay depending on the input range, configuration open-circuit principle

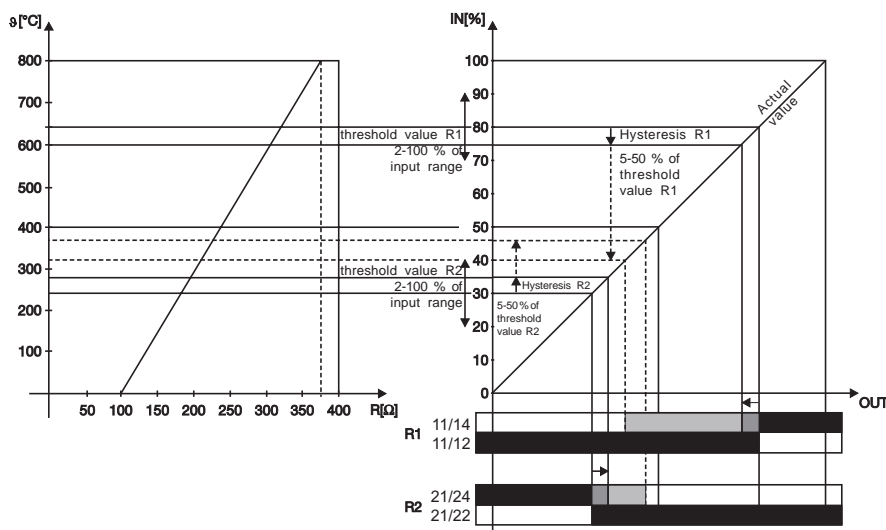

Type	Supply voltage 50/60 Hz	Order code	Pack. unit pieces	Price 1 piece
CC-U/RTDR	24-48 V DC / 24 V AC	1SVR 040 012 R2600	1	
	110-240 V AC / 100-300 V DC	1SVR 040 013 R2700	1	

• Technical data 182 • Dimensional drawings 183

Temperature signal converter for thermocouples CC-E/TC

Ordering details

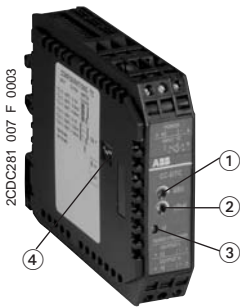

CC-E/TC

- ① Gain adjustment
- ② Offset adjustment
- ③ U: green LED - supply voltage
- ④ DIP switch for input and output configuration (only available on universal devices)

CC-E/TC analog signal converter for thermocouple signals of the types J and K with 3-way electrical isolation

- Universally configurable device (type E/TC)
- 6 single-function devices
- "Plug and Play", no adjustment of single-function devices required

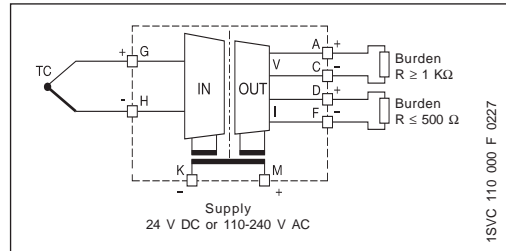

DIP switch settings for CC-E/TC (universal)

Input	Output	SW1					
		1	2	3	4	5	6
TC-J: 0 ... 600 C	0 ... 10 V						
TC-J: 0 ... 600 C	0 ... 20 mA						
TC-J: 0 ... 600 C	4 ... 20 mA						
TC-K: 0 ... 1000 C	0 ... 10 V						
TC-K: 0 ... 1000 C	0 ... 20 mA						
TC-K: 0 ... 1000 C	4 ... 20 mA						
High fail safe							
Low fail safe							

Legend:
 ON
 OFF
 no influence

Type	Input signal	Output signal	Order code	Price 1 piece
------	--------------	---------------	------------	---------------

Supply voltage: 24 V DC
universal

CC-E/TC	thermocouple types J and K	0-10 V, 0-20 mA, 4-20 mA	1SVR 011 702 R2600 ¹⁾	
single-function				
CC-E TC/V	type J 0-600 °C	0-10 V	1SVR 011 750 R0100	
CC-E TC/I		0-20 mA	1SVR 011 751 R2600	
CC-E TC/I		4-20 mA	1SVR 011 752 R2700	
CC-E TC/V	type K 0-1000 °C	0-10 V	1SVR 011 753 R2000	
CC-E TC/I		0-20 mA	1SVR 011 754 R2100	
CC-E TC/I		4-20 mA	1SVR 011 755 R2200	

Supply voltage: 110-240 V AC
universal

CC-E/TC	thermocouple types J and K	0-10 V, 0-20 mA, 4-20 mA	1SVR 011 707 R2300	
single-function				
CC-E TC/V	type J 0-600 °C	0-10 V	1SVR 011 760 R0300	
CC-E TC/I		0-20 mA	1SVR 011 761 R2000	
CC-E TC/I		4-20 mA	1SVR 011 762 R2100	
CC-E TC/V	type K 0-1000 °C	0-10 V	1SVR 011 763 R2200	
CC-E TC/I		0-20 mA	1SVR 011 764 R2300	
CC-E TC/I		4-20 mA	1SVR 011 765 R2400	

¹⁾ UL 1604 Class I, Div.2
(universal devices)

Pack. units: 1 piece

• Technical data 177 • Dimensional drawings 183

Temperature signal converter for thermocouples CC-U/TC

Ordering details

2CDC 281 008 F 0003

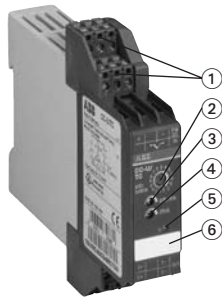

CC-U/TC

- ① Plug-in connecting terminals
- ② Gain: Coarse adjustment
- ③ Gain: Fine adjustment
- ④ Offset adjustment
- ⑤ U: green LED - supply voltage
- ⑥ Marker

CC-U/TC universal signal converter for thermocouples with 3-way electrical isolation

- Temperature signal converter for thermocouples of the types K, J, T, S, E, N, R, B
- Continuously adjustable voltage signal input 0-10 mV and 0-50 mV
- Differential temperature meas. possible ¹⁾
- Configurable output signal response on input signal interruption (low fail safe / high fail safe)
- Adjustment and operating elements on the front-side
- Short-circuit proof signal outputs
- Plug-in connecting terminals for inputs, outputs and supply

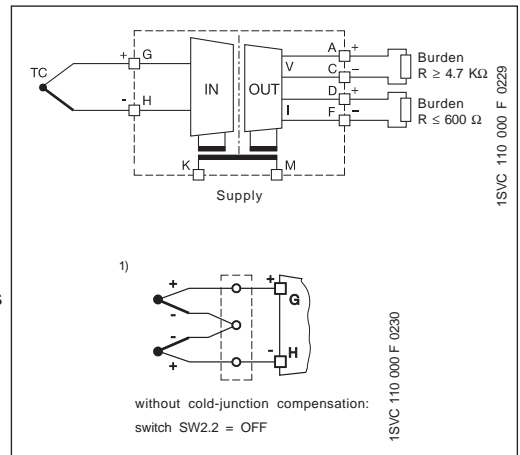

DIP switch settings

Input		SW1						SW2					
Typ	Temperature range	1	2	3	4	5	6	1	2	3	4	5	6
K	0-100...900 °C												
K	0-250...1350 °C												
J	0-100...750 °C												
T	0-100...400 °C												
T	-150...400 °C												
S	0-250...1550 °C												
E	0-100...700 °C												
E	0-200...1000 °C												
N	0-100...650 °C												
N	0-200...1300 °C												
R	0-250...1350 °C												
R	0-450...1700 °C												
B	0-700...1750 °C												
mV	0-2...10 mV												
mV	0-10...50 mV												
LOW FAIL SAFE [*]													
HIGH FAIL SAFE [*]													

Output	SW2					
	1	2	3	4	5	6
0...5 V						
0...10 V						
1...5 V						
5...10 V						
-10...+10 V						
-5...+5 V						
-10...0 V						
-5...0 V						
0...+6.66 V						
-10...+3.33 V						
-5...+1.66 V						
0...+3 V						
0...+4 V						
-10...-2 V						
-5...-1 V						
1.25...+2.25 V						
-7.5...-2.5 V						
-3.75...-1.25 V						
1.66...+3.33 V						
-6.66...+6.66 V						
-3.33...+3.33 V						
-8...0 V						
0...+1 mA						
0...+20 mA						
4...+20 mA						
0...+10 mA						
0...+0.5 mA						
0...+13.33 mA						
0...+6.66 µA						
0...+16 mA						
0...+300 µA						
0...+8 mA						
0...+400 µA						
2.5...+12.5 mA						
125...+625 µA						
3.33...+16.66 mA						
166...+833 µA						
0.2...+1 mA						
2...+10 mA						
100...+500 µA						

^{*} Detection of input signal interruptions:
If the input signal circuit is interrupted, the output signal changes to the adjusted minimum value (low fail safe) or maximum value (high fail safe).

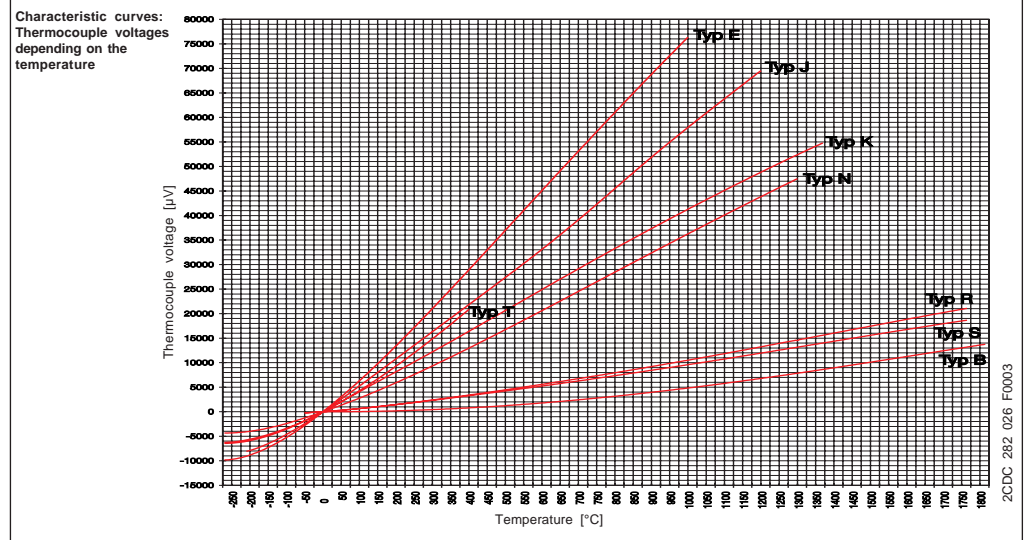

Type	Supply voltage 50/60 Hz	Order code	Pack. unit pieces	Price 1 piece
CC-U/TC	24-48 V DC / 24 V AC 110-240 V AC / 100-300 V DC	1SVR 040 004 R0700 1SVR 040 005 R0000	1	

• Technical data 180 • Dimensional drawings 183

Temperature signal converter for thermocouples CC-U/TCR with relay output

Ordering details

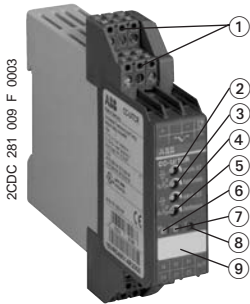

CC-U/TCR

- ① Plug-in connecting terminals
- ② Threshold value for R1
- ③ Hysteresis for R1
- ④ Threshold value for R2
- ⑤ Hysteresis for R2
- ⑥ U: green LED - supply voltage
- ⑦ R2: yellow LED - Relay 2 energized
- ⑧ R1: yellow LED - Relay 1 energized
- ⑨ Marker

CC-U/TCR universal signal converter for thermocouples, with 2 threshold relay outputs and 3-way electrical isolation

- Temperature signal converter for thermocouples of the types K, J, T, S
- 2 threshold relay outputs with one change-over contact each (threshold and respective hysteresis can be adjusted independently from each other)
- Open-circuit or closed-circuit principle configurable by means of a DIP switch
- 2 yellow LEDs for clear status indication of the output relays
- Plug-in connecting terminals for inputs, outputs and supply

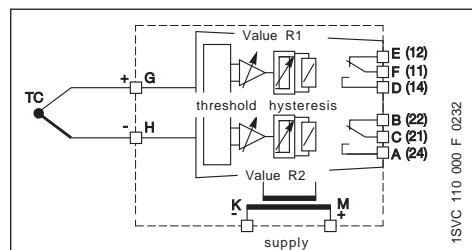

DIP switch settings

Input	SW1					
Typ	1	2	3	4	5	6
J 0...240 °C						
J 0...480 °C						
J 0...1200 °C						
K 0...250 °C						
K 0...500 °C						
K 0...1350 °C						
T -150...+120 °C						
T 0...220 °C						
T 0...400 °C						
S 0...210 °C						
S 0...380 °C						
S 0...860 °C						
S 0...1650 °C						
Closed-circuit principle						
Open-circuit principle						

Legend:
 ■ ON
 □ OFF
 ◻ no influence

Function diagrams CC-U/TCR

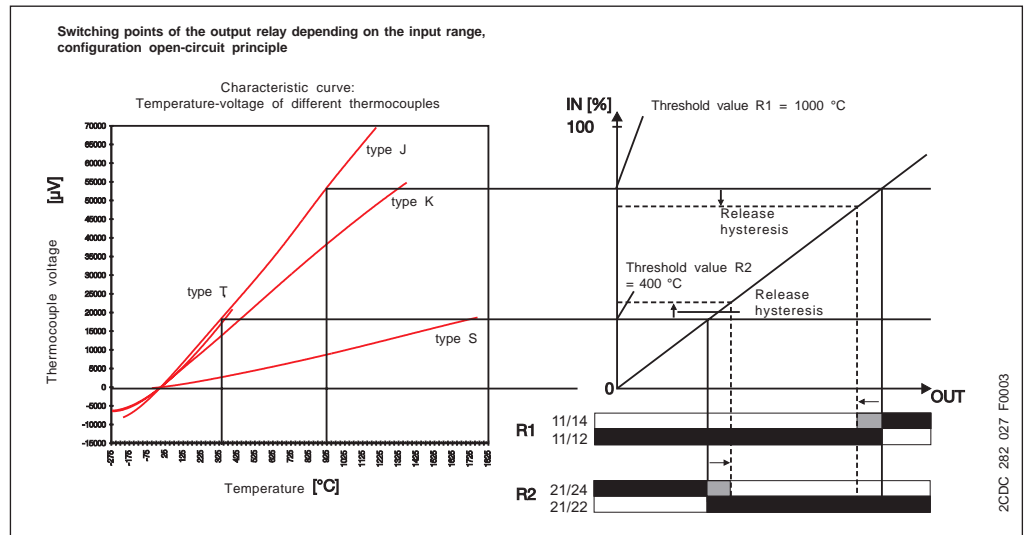
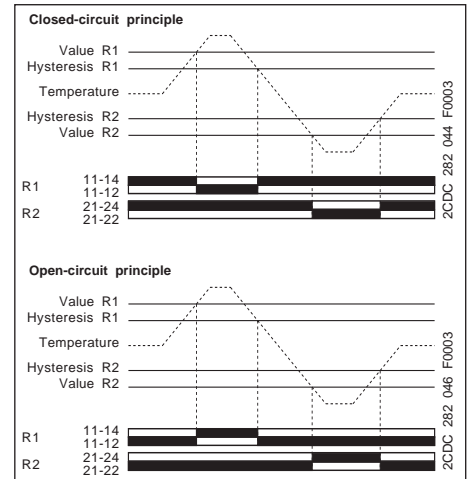

Type	Supply voltage 50/60 Hz	Order code	Pack. unit pieces	Price 1 piece
CC-U/TCR	24-48 V DC / 24 V AC 110-240 V AC / 100-300 V DC	1SVR 040 014 R2000 1SVR 040 015 R2100	1 1	

• Technical data 182 • Dimensional drawings 183



Measuring converter for sinusoidal and DC currents CC-E/I Ordering details

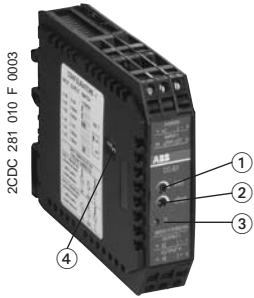

CC-E/I

- ① Gain adjustment
- ② Offset adjustment
- ③ U: green LED - supply voltage
- ④ DIP switch for input and output configuration (only available on universal devices)

CC-E/I current measuring converter for current signals 0-5 A, 0-20 A, AC/DC with 3-way electrical isolation

- Universally configurable device (type E/I)
- 6 single-function devices
- "Plug and Play", no adjustment of single-function devices required

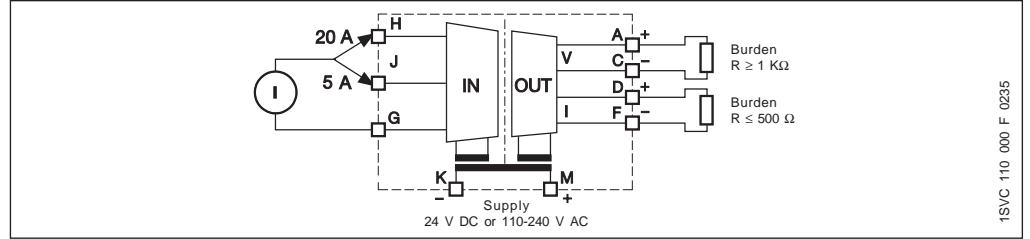

DIP switch settings

Select input range by terminals		
Input range 5 A	<input type="checkbox"/>	<input type="checkbox"/>
Connected lines	<input type="checkbox"/>	<input type="checkbox"/>
Used terminals	<input type="checkbox"/>	<input type="checkbox"/>
Terminal marking	5 A	20 A
Input range 20 A	<input type="checkbox"/>	<input type="checkbox"/>
Connected lines	<input type="checkbox"/>	<input type="checkbox"/>
Used terminals	<input type="checkbox"/>	<input type="checkbox"/>
Terminal marking	5 A	20 A

Input	Output	SW1					
		1	2	3	4	5	6
I - DC	0 ... 10 V	■					
I - AC	0 ... 10 V						
I - DC	0 ... 20 mA		■				
I - AC	0 ... 20 mA						
I - DC	4 ... 20 mA		■	■			
I - AC	4 ... 20 mA			■	■		

Legend: ■ ON, □ OFF

Type	Input signal	Output signal	Order code	Price 1 piece
------	--------------	---------------	------------	---------------

Supply voltage: 24 V DC
universal

CC-E/I	0-5 A, 0-20 A, AC/DC	0-10 V, 0-20 mA, 4-20 mA	1SVR 011 703 R2700 ¹⁾	
single-function				
CC-E I_{AC}/V		0-10 V	1SVR 011 770 R0500	
CC-E I_{AC}/I	0-5 A, 0-20 A, AC	0-20 mA	1SVR 011 771 R2200	
CC-E I_{AC}/I		4-20 mA	1SVR 011 772 R2300	
CC-E I_{DC}/V		0-10 V	1SVR 011 773 R2400	
CC-E I_{DC}/I	0-5 A, 0-20 A, DC	0-20 mA	1SVR 011 774 R2500	
CC-E I_{DC}/I		4-20 mA	1SVR 011 775 R2600	

Supply voltage: 110-240 V AC
universal

CC-E/I	0-5 A, 0-20 A, AC/DC	0-10 V, 0-20 mA, 4-20 mA	1SVR 011 708 R0400	
single-function				
CC-E I_{AC}/V		0-10 V	1SVR 011 780 R1100	
CC-E I_{AC}/I	0-5 A, 0-20 A, AC	0-20 mA	1SVR 011 781 R0600	
CC-E I_{AC}/I		4-20 mA	1SVR 011 782 R0700	
CC-E I_{DC}/V		0-10 V	1SVR 011 783 R0000	
CC-E I_{DC}/I	0-5 A, 0-20 A, DC	0-20 mA	1SVR 011 784 R0100	
CC-E I_{DC}/I		4-20 mA	1SVR 011 785 R1100	

¹⁾ 1604 Class I, Div.2 (universal devices)

Pack. units: 1 piece

• Technical data 178 • Dimensional drawings 183

Measuring converter for sinusoidal currents

CC-E $I_{AC}/ILPO$

Ordering details

2CDC 281 xxx

CC-E $I_{AC}/ILPO$

CC-E $I_{AC}/ILPO$ current measuring without auxiliary power for sinusoidal currents
0-1 A, 0-5 A, output 4 - 20 mA

- Measuring converter for sinusoidal AC currents (0-1 A, 0-5 A)
- Measuring range selection by front-face sliding switch
- 4-20 mA output current in proportion to input current
- no additional power supply required

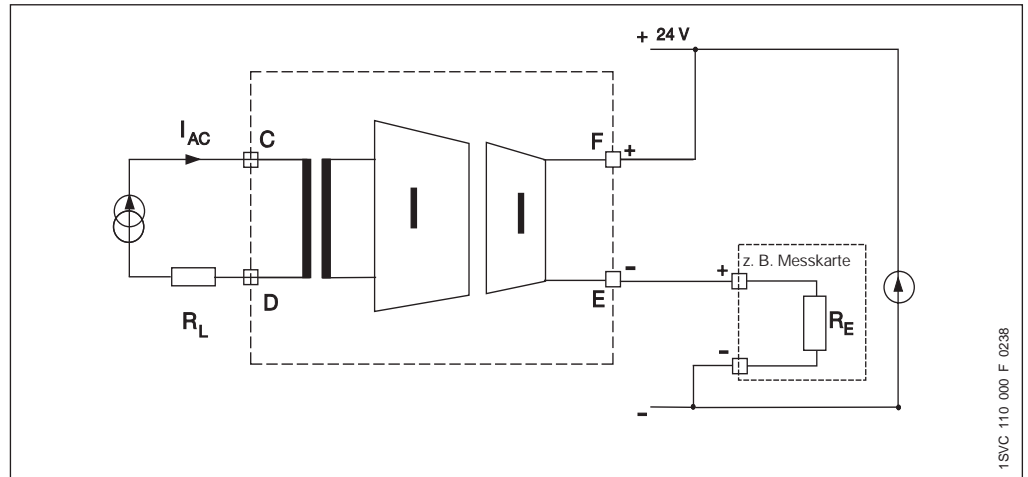

1SVU 110 000 F 0238

Type	Input signal	Order code	Pack. unit piece	Price 1 piece €
CC-E $I_{AC}/ILPO$	0-1 A, 0-5 A, AC	1SVU 010 203 R0500	1	

• Technical data 178 • Dimensional drawings 183

Measuring converter for current RMS values CC-U/I Ordering details

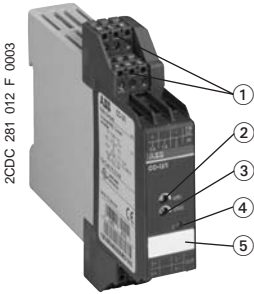

CC-U/I

- ① Plug-in connecting terminals
- ② Gain adjustment
- ③ Offset adjustment
- ④ U: green LED - supply voltage
- ⑤ Marker

CC-U/I universal current measuring converter for RMS values of 0-1 A and 0-5 A, with 3-way electrical isolation

- RMS converter for current signals up to 1 A and up to 5 A of any wave form (DC, DC with superimposed AC components, pure sinusoidal, triangular, phase-angle controlled, etc. in a measuring range of 0-600 Hz)
- Adjustment and operating elements on the front-face
- Short-circuit proof signal outputs
- Plug-in connecting terminals for inputs, outputs and supply

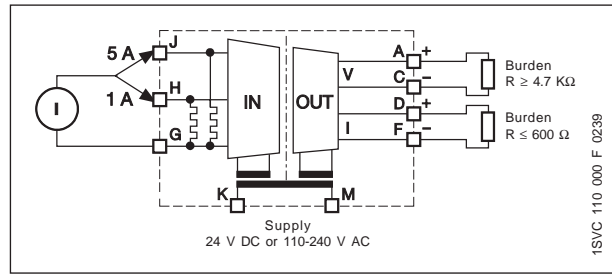

DIP switch settings

Output	SW1					
	1	2	3	4	5	6
0...5 V						
0...10 V						
1...5 V	■	■	■	■	■	■
2...10 V	■	■	■	■	■	■
-10...10 V						
-5...5 V						
-10...0 V						
-5...0 V						
0...6.66 V						
-10...3.33 V						
-5...1.66 V						
0...3 V						
0...4 V						
-10...-2 V						
-5...-1 V						
1.25...6.25 V						
-7.5...-2.5 V						
-3.75...-1.25 V						
1.66...6.33 V						
-6.66...6.66 V						
-3.33...3.33 V						
-3...0 V						
-4...0 V						
0...1 mA						
0...20 mA						
4...20 mA						
0...10 mA						
0...0.5 mA						
0...13.33 mA						
0...6.66 mA						
0...16 mA						
0...800 μA						
0...8 mA						
0...400 μA						
2.5...12.5 mA						
125...625 μA						
3.33...16.66 mA						
166...833 μA						
0...1 mA						
2...10 mA						
100...500 μA						

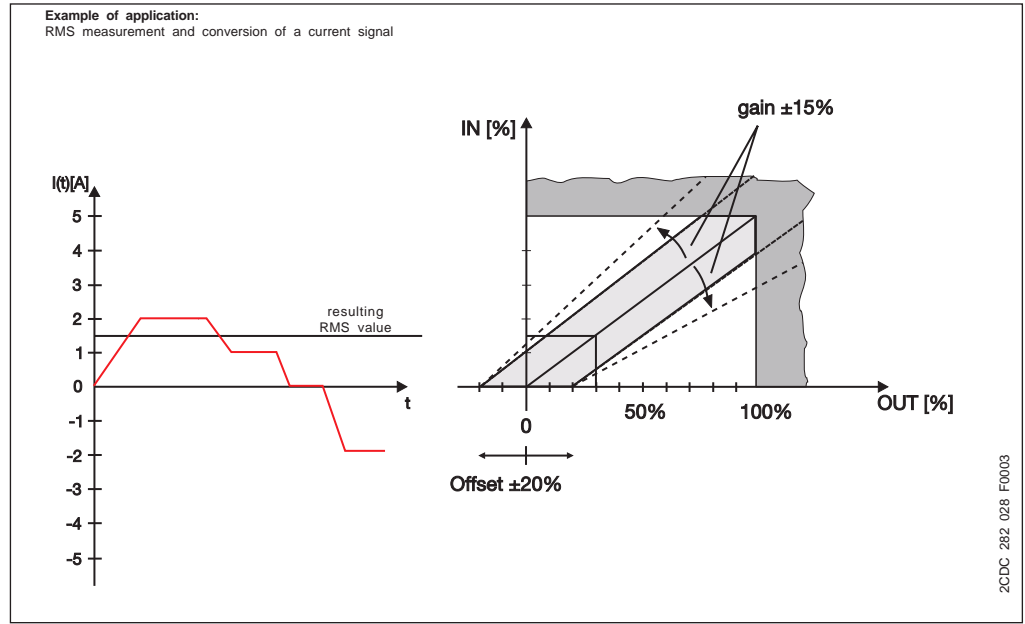
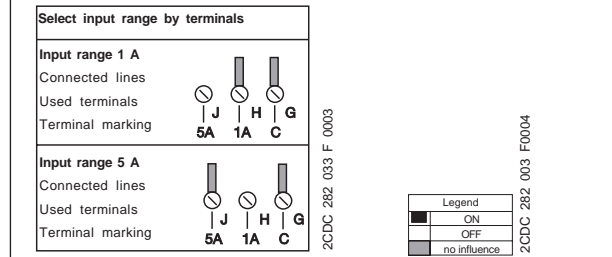

Type	Supply voltage 50/60 Hz	Order code	Pack. unit pieces	Price 1 piece
CC-U/I	24-48 V DC / 24 V AC	1SVR 040 006 R0100	1	
	110-240 V AC / 100-300 V DC	1SVR 040 007 R0200	1	

• Technical data 181 • Dimensional drawings 183



Measuring converter for voltage RMS values CC-U/V

Ordering details

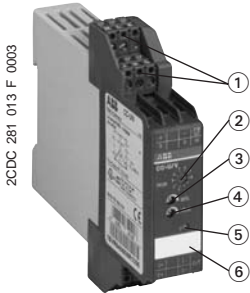

CC-U/V

- ① Plug-in connecting terminals
- ② Input voltage range selection
- ③ Gain adjustment
- ④ Offset adjustment
- ⑤ U: green LED - supply voltage
- ⑥ Marker

CC-U/V universal voltage measuring converter for RMS values of 0-600 V, with 3-way electrical isolation

- RMS converter for voltage signals up to 600 V of any wave form (DC, DC with superimposed AC components, pure sinusoidal, triangular, phase-angle controlled, etc. in a measuring range of 0-600 Hz)
- Adjustment and operating elements on the front-face
- Short-circuit proof signal outputs
- Plug-in connecting terminals for inputs, outputs and supply

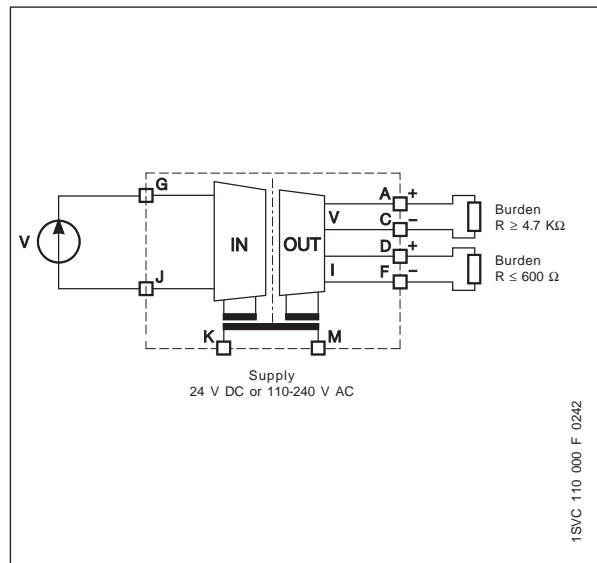

DIP switch settings

Output	SW1					
	1	2	3	4	5	6
0...5 V						
0...10 V						
1...5 V						
2...10 V						
-10...+10 V						
-5...+5 V						
-10...0 V						
-5...0 V						
0...6,66 V						
-10...3,33 V						
-5...1,66 V						
0...8 V						
0...4 V						
-10...-2 V						
-5...-1 V						
1,25...6,25 V						
-7,5...2,5 V						
-3,75...1,25 V						
1,66...8,33 V						
-6,66...6,66 V						
-3,33...3,33 V						
-8...0 V						
-4...0 V						
0...1 mA						
0...20 mA						
4...20 mA						
0...10 mA						
0...0,5 mA						
0...13,33 mA						
0...666 µA						
0...16 mA						
0...800 µA						
0...8 mA						
0...400 µA						
2,5...12,5 mA						
125...625 µA						
3,33...16,66 mA						
166...833 µA						
0,2...1 mA						
2...10 mA						
100...500 µA						

Measuring voltage ranges

Selecting input range by front-face rotary switch	Switch position
0...100 V	1
0...150 V	2
0...250 V	3
0...300 V	4
0...400 V	5
0...450 V	6
0...550 V	7
0...600 V	8

Legend	
■	ON
□	OFF
□	no influence

Example of application:

RMS measurement and conversion of a phase-angle controlled voltage signal $L1 = 230\text{ V}$

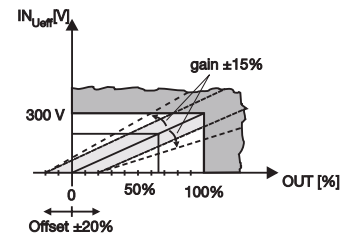
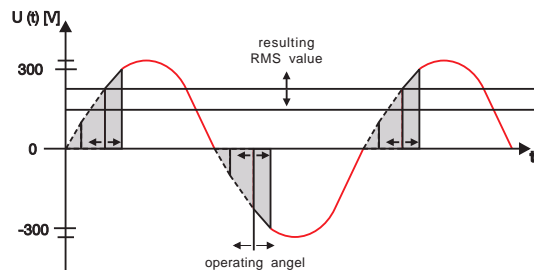

Type	Supply voltage 50/60 Hz	Order code	Pack unit pieces	Price 1 piece
CC-U/V	24-48 V DC / 24 V AC	1SVR 040 008 R1300	1	
	110-240 V AC / 100-300 V DC	1SVR 040 009 R1400	1	

• Technical data 181 • Dimensional drawings 183

Analog signal converters

CC-E/STD, CC-E/RTD, CC-E/TC

Technical data

Input circuits J-G-H	CC-E/STD		CC-E/RTD	CC-E/TC
	Current	Voltage	Temperature sensors	Thermocouples (IEC 584-1 and -2)
Input signal	0-20 mA / 4-20 mA	0-5 V / 0-10 V / -10...+10 V	PT100	TC.K, TC.J
Input measuring range			-50 ... +500 °C	TC.K 0-1000 °C, TC.J 0-600 °C
Limitation of input signals	+55 mA	± 11 V		
Influence of line resistance			< 0.01 %/Ω	> 0.5 % / 100 Ω
Gain adjustment range			± 5 % (universal devices)	
Offset adjustment range			± 5 % (universal devices)	
Input impedance	50 Ω	1 mΩ		
Suppression at 50 Hz				> 35 dB
Common-mode rejection				100 dB
Output circuits D-F A-C	Current		Voltage	
Output signal	0-20 mA, 4-20 mA		0-5 V, 0-10 V	
Output burden	≤ 500 Ω		≥ 1.0 KΩ	
Accuracy	Factory setting		± 0,1 % of full-scale	
	Repeat accuracy ¹⁾		± 0,5 % of full-scale	
Temperature coefficient			± 500 ppm/°C	
Residual ripple			< 0.5 %	
Response time	200 μs		10 ms	
Transmission frequency	2 kHz		80 Hz	2 Hz (up to -3 dB)
Response to input circuit interruption			Low Fail Safe: Output voltage > 15 % of measuring range ²⁾	
			Low Fail Safe: Output voltage < -0.6 V, output current = 0 mA	
Supply circuits K - M	DC versions		AC versions	
Supply voltage	24 V DC		110-240 V AC - 50/60 Hz	
Supply voltage tolerance	-15 % ... + 15 %		-15 % ... + 10 %	
Power consumption	1.5 W typ.		1.5 VA typ.	
Indication of operational states				
Supply voltage			U: green LED	
Isolation data				
Test voltage between all isolated circuits			2.5 kV AC	
Rated insulation voltage	-		-	-
General data				
Operating temperature			0...+60 °C	
Storage temperature			-20...+80 °C	
Degree of protection acc. to DIN 40050			IP20	
Mounting position			ventilation slots on top and bottom	
Mounting on DIN rail			snap-on mounting	
Wire size	solid wire		4 mm ² (10 AWG)	
	stranded wire		2.5 mm ² (14 AWG)	
Electromagnetic compatibility				
Interference immunity acc. to EN 61000-6-2				
electrostatic discharge (ESD) acc. to IEC/EN 61000-4-2	level 3		±6 kV / ±8 kV	
electromagnetic field acc. to IEC/EN 61000-4-3			10 V/m	
fast transients (Burst) acc. to IEC/EN 61000-4-4	level 3		±2 kV / 5 kHz	
powerful impulses (Surge) acc. to IEC/EN 61000-4-5			±2 kV / ±1 kV	
HF line emission acc. to IEC/EN 61000-4-6			10 V	
Interference emission acc. to EN 61000-6-4			class B	

¹⁾ Constant parameters

²⁾ Only -/RTD and -/TC: Single-function devices respond with LOW FAIL SAFE to input signal interruptions

Analog signal converters

CC-E/I, CC-E I_{AC}/ILPO

Technical data

Input circuits	CC-E/I		CC-E I _{AC} /ILPO
	J-G-H AC current meas.	DC current meas.	C-D 2 meas. ranges selectable
Input signal	0-5 A / 0-20 A	0-5 A / 0-20 A	0-1 A / 0-5 A / sinusförmig
Measuring frequency			50/60 Hz
Overload capacity of inputs	10 x I _{Nom} for max. 1 s		10 x I _{Nom} for max. 2 s
Gain adjustment range	± 5 % (univ. device)		-
Offset adjustment range	± 5 % (univ. device)		-
Input impedance / resistance	5A : 65 Ω	20 A : 2.5 mΩ	5 mΩ
Output circuits	D-F Current	A-C Voltage	F-E passive current output in proportion to input current
Output signal	0-20 mA / 4-20 mA	0-10 V	4-20 mA
Output burden / load	≤ 500 Ω	≥ 1,0 Ω	12 V DC - 150 Ω, 24 V DC - 750 Ω 30 V DC - 1050 Ω
Accuracy	Factory setting		± 0.1 % of full scale
	Repeat accuracy ¹⁾		± 2 % of full scale
Offset adjustment range	-		± 5 %
Gain adjustment range	-		± 20 %
Temperature coefficient	± 500 ppm/°C		300 ppm/°C
Residual ripple	< 0.5 %		-
Response time	0.5 s		-
Transmission frequency	DC or 50/60 Hz		-
Response to circuit interruption	Low Fail Safe: output voltage < 200 mA, output current < 400 µA		-
Supply circuits K - M	DC versions	AC versionv	
Supply voltage	24 V DC	110-240 V AC 50/60 Hz	12-30 V DC
Supply voltage tolerance	-15 % ... + 15 %	-15 % ... + 10 %	-
Power consumption	typ 1.5 W	typ 1.5 VA	-
Indication of operational states			
Supply voltage	U: green LED		-
Isolation data			
Test voltage between all isolated circuits	2.5 kV AC		
Rated insulation voltage	-		250 V AC
General data			
Temperature range	operation	0...+60 °C	-20...+60 °C
	storage	-20...+80 °C	-40...+80 °C
Degree of protection acc. to DIN 40050	IP20		
Mounting position	ventilation slots on top and bottom		
Mounting on DIN rail	snap-on mounting		
Wire size	solid wire	4 mm ² (10 AWG)	1x2.5 mm ² (14 AWG)
	stranded wire	2,5 mm ² (14 AWG)	
Electromagnetic compatibility			
Interference immunity	acc. to. EN 61000-6-2		
electrostatic discharge (ESD)	acc. to IEC/EN 61000-4-2	level 3	±6 kV / ±8 kV
electromagnetic field	acc. to IEC/EN 61000-4-3		10 V/m
fast transients (Burst)	acc. to IEC/EN 61000-4-4	level 3	±2 kV / 5 kH
powerful impulses (Surge)	acc. to IEC/EN 61000-4-5		±2 kV / ±1 kV
HF line emission	acc. to IEC/EN 61000-4-6		10 V
Interference emission	acc. to EN 61000-6-4		class B

¹⁾ Constant parameters

NEW

Analogsignal converter CC-E I/I Technical data

Input circuit		channel 1: A (+), B (-), channel 2: C (+), D (-)	
Input current I_{IN}		0-20 mA, 4-20 mA	
Input current minimum		< 100 μ A	
Input current maximum		50 mA ¹⁾ ($V_{IN} < 18$ V)	
Input voltage V_{IN}		$V_{IN} < 2.5$ V + ($I_{IN} \times R_L$)	
Input voltage drop V_I		< 2.5 V (20 mA, $R_L = 0\Omega$)	
Input voltage maximum		18 V ¹⁾ ($I_{IN} < 50$ mA)	
Output circuit		channel 1: H (+), G (-), channel 2: F (+), E (-)	
Output current I_{OUT}		0-20 mA, 4-20 mA	
Output load R_L		0-500 Ω	
Output voltage V_{OUT}		$V_{OUT} = I_{OUT} \times R_L$	
Residual ripple		< 20 mV _{pp} (500 Ω , 20 mA)	
Response time (0-100 %)		< 15 ms (0-500 Ω , 20 mA), < 5 ms (500 Ω , 20 mA, 25 °C)	
Accuracy output to input current		≤ 0.1 % of full scale (20 mA)	
Temperature coefficient		< ± 50 ppm / °C	
Load influence (0-500 Ω)		$\leq \pm 0.05$ % / 100 Ω , ≤ -0.1 % / 100 Ω (25 °C)	
General data			
Width of the enclosure		18 mm	
Wire size		max. 2.5 mm ² (14 AWG)	
Weight	1 channel	approx. 0.037 kg / 0.082 lb	
	2 channel	approx. 0.044 kg / 0.097 lb	
Mounting position		any	
Degree of protection	enclosure / terminals	IP 20 / IP 20	
Temperature range	operation	-25...+60 °C	
	storage	-40...+85 °C	
Mounting		DIN rail (EN 50022)	
Standards			
Product standard		EN 50178	
Low Voltage Directive		73/23/EEC	
EMC Directive		89/336/EEC	
Electromagnetic compatibility			
Interference immunity	acc. to EN 61000-6-2		
electrostatic discharge (ESD)	acc. to EN 61000-4-2	level 3	± 6 kV / ± 8 kV
electromagnetic field	acc. to EN 61000-4-3		10 V/m
fast transients (Burst)	acc. to EN 61000-4-4	level 3	± 2 kV / 5 kHz
powerfull impulses (Surge)	acc. to EN 61000-4-5		± 2 kV / ± 1 kV
HF line emission	acc. to EN 61000-4-6		10 V
magnetic field	acc. to EN 61000-4-8	30 A/m	
Interference emission	acc. to EN 61000-6-4		
Radiated noise	acc. to EN 55011	class B	
Operational reliability	acc. to EN 68-2-6	4 g	
Mechanical resistance	acc. to EN 68-2-6	10 g	
Environmental testing	acc. to IEC 68-2-30 Db	24 h cycle, 55 °C, 93 % rel., 96 h	
Isolation data			
Insulation voltage input / output		500 V _{eff} / 50 Hz	
Insulation voltage between channels (device with 2 channels)		5 kV _{eff} / 50 Hz	
Pollution category		II	
Overvoltage category		II	

¹⁾ The input parameters have to be limited to the indicated maximum values.

Analog signal converters

CC-U/STD, CC-U/RTD, CC-U/TC

Technical data

Input circuits J-G-H	CC-U/STD			CC-URTD	CC-U/TC
	Current	Voltage	Potentiometer	temperature sensors	Thermocouples (IEC 584-1 and 2)
Input signals	0-20 mA 4-20 mA 10-50 mA 0-1 mA	0-100 mV 0-1 V 0-5 V 1-5 V 0-10 V 2-10 V ± 10 V	470 Ω ... 1 MΩ	PT10, PT100, PT1000 (IEL 751 and JICC 1604)	TC.K TC.J TC.T TC.S TC.E TC.N TC.R TC.B
Limitation of input signals	± 55 mA	± 11 V	10 kΩ	-	-
Temperature range	-	-	-	Max. Temperature adjustable: 6-60 °C for PT1000 50-500 °C for PT100 500-850 °C for PT 10	refer to temperature specs. of individual thermocouples
Influence of line resistance	-	-	-	0.015 °C/Ω	< 0.01 % / 100 Ω
Gain adjustment range (univ. devices)	0.9-110 mA	45 mV - 22 V	-	-	-
Offset adjustment range (univ. devices)	-137.5 % ... +62.5 %			± 5 %	± 10 %
Input impedance	for different ranges			-	-
without detection of input signal interruption	51 Ω	6 MΩ	3 GΩ	-	-
with detection of input signal interruption	51 Ω	3.5 MΩ	9.5 GΩ	-	-
Suppression at 50 Hz	-	-	-	-	> 40 dB
Common-mode rejection	-	-	-	120 dB	105 dB
Output circuit D-F A-C	Current		Voltage		
Output signals	0-20 mA, 4-20 mA		0-5 V, 1-5 V, 0-10 V, 2-10 V, ±10 V		
Output burden	≤ 600 Ω		≥ 4,7 kΩ		
Accuracy	±0,1 % of full-scale		±0,2 % of full-scale		±0,1 % of full-scale
Temperature coefficient	±150 ppm/°C		±250 ppm/°C		±200 ppm/°C at min offset ±400 ppm/°C at max. offset
Residual ripple	-	-	-	< 0,15 %	-
Response time	200 μs		10 ms		200 ms
Transmission frequency	1 kHz		80 Hz		2 Hz (bis -3 dB)
Supply circuits K - M					
Supply voltage	24-48 V DC / 24 V AC		110-240 V AC / 100-300 V DC		
Supply voltage tolerance	DC: -15 % ... + 15 %		AC: -15 % ... + 10 %		
Power consumption	2 W at 24 V DC		4.5 VA at 230 V AC		
Indication of operational states					
Supply voltage			U: green LED		
Isolation data (between all isolated circuits)					
Isolation test			1.5 kV		
Test voltage			1.5 kV / 50 Hz		
General data					
Operating temperature			-20...+60 °C		
Storage temperature			-40...+80 °C		
Mounting position			any		
Mounting on DIN rail			snap-on mounting / screw mounting with adapter		
Wire size	solid wire	plug-connector with screw terminals 1.5 mm ² (16 AWG)			
	stranded wire	plug-connector with screw terminals 2.5 mm ² (14 AWG)			
Electromagnetic compatibility					
Interference immunity acc. to EN 61000-6-2					
electrostatic discharge (ESD) acc. to IEC/EN 61000-4-2			level 3	±6 kV / ±8 kV	
electromagnetic field acc. to IEC/EN 61000-4-3			10V/m		
fast transients (Burst) acc. to IEC/EN 61000-4-4			level 3	±2 kV / 5 kH	
powerful impulses (Surge) acc. to IEC/EN 61000-4-5			±2 kV / ±1 kV		
HF line emission acc. to IEC/EN 61000-4-6			10 V		
Interference emission acc. to EN 61000-6-4			class B		

Analog signal converters

CC-U/I, CC-U/V

Technical data

Input circuits J-G-H	CC-U/I any current signals, RMS measurement	CC-U/V any voltage signals, RMS measurement	
Measuring signals	0-1 A 0-5 A	0-100 V, 0-200 V 0-300 V, 0-400 V 0-500 V, 0-600 V	
Measuring frequency	0-600 Hz		
Overload capacity of inputs	10 x I _{Non.} for max. 2 s	-	
Gain adjustment range	±20 %		
Offset adjustment range	±15 %		
Input impedance / resistance	60 mΩ / 12 mΩ	> 800 kΩ	
Output circuits D-F A-C	Current	Voltage	
Output signal	0-20 mA, 4-20 mA	0-5 V, 1-5 V, 0-10 V, 2-10 V, ±10 V	
Output load	≤ 600 Ω	≤ 4,7 kΩ	
Accuracy	0,5 %		
Temperature coefficient	±250 ppm/°C max.	±300 ppm/°C max.	
Residual ripple	< 0.15 %		
Response time	150 ms		
Supply circuit K - M			
Supply voltage	24-48 V DC / 24 V AC	110-240 V AC / 100-300 V DC	
Supply voltage tolerance	DC: -15 % ... + 15 %	AC: -15 % ... + 10 %	
Power consumption	2 W at 24 V DC	4.5 VA at 230 V AC	
Indication of operational states			
Supply voltage	U: green LED		
Isolation data (between all isolated circuits)			
Insulation voltage	1.5 kV		
Test voltage	1.5 kV / 50 Hz		
General data			
Operating temperature	-20...+60 °C		
Storage temperature	-40...+80 °C		
Mounting position	any		
Mounting on DIN rail (EN 50022)	snap-on mounting / screw mounting with adapter		
Wire size	solid wire	plug-connector with screw terminals 1.5 mm ² (16 AWG)	
	stranded wire	plug-connector with screw terminals 2.5 mm ² (14 AWG)	
Electromagnetic compatibility			
Interference immunity	acc. to EN 61000-6-2		
electrostatic discharge (ESD)	acc. to IEC/EN 61000-4-2	level 3 ±6 kV / ±8 kV	
electromagnetic field	acc. to IEC/EN 61000-4-3	10 V/m	
fast transients (Burst)	acc. to IEC/EN 61000-4-4	level 3 ±2 kV / 5 kH	
powerful impulses (Surge)	acc. to IEC/EN 61000-4-5	±2 kV / ±1 kV	
HF line emission	acc. to IEC/EN 61000-4-6	10 V	
Interference emission	acc. to EN 61000-6-4	class B	

Analog signal converters with relay output CC-U/STDR, CC-U/RTDR, CC-U/TCR

Technical data

Input circuits J - H	CC-U/STDR		CC-U/RTDR	CC-U/TCR
	Current	Voltage	Temperature sensors	Thermocouples (IEC 584-1 and -2)
Measuring signal / input range	0-20 / 4-20 mA	0-1 V / 1-5 V / 0-10 / ±10 V	PT100	TC.K, TC.J, TC.T, TC.S
Input burden	50 Ω	> 5 mΩ		
Adjustable threshold	2-100 % of selected input range			
Adjustable hysteresis	5-50 % of threshold			
Accuracy	0.5 %			
Temperature coefficient	±300 ppm/°C			
Output circuits E - D - F, B - C - A			Relay, 2 c/o contacts	
Rated switching voltage	250 V AC			
Rated switching current				
AC-12 (resistive) 230 V	4 A			
AC-15 (inductive) 230 V	3 A			
DC-12 (resistive) 24 V	4 A			
DC-13 (inductive) 24V	2 A			
Min. switching voltage	12 V			
Min. switching current / power	10 mA / 0.6 VA (W)			
Response time	10 ms			
Max. lifetime	30 x 10 ⁶ switching cycles			
mechanical				
electrical (AC-12, 230 V, 4 A)	0.1 Mio. switching cycles			
Supply circuits K - M				
Supply voltage	24-48 V DC / 24 V AC		110-240 V AC / 100-300 V DC	
Supply voltage tolerance	DC: -15 %...+15 %		AC: -15 % ... +10 %	
Power consumption	2 W at 24 V DC		4.5 VA at 230 V AC	
Indication of operational states				
Supply voltage	U: green LED			
1st / 2nd output relay energized	R1: yellow LED / R2: yellow LED			
Isolation data (between all isolated circuits)				
Insulation voltage	2.5 kV			
Test voltage	2.5 kV			
General data				
Temperature range	operation	-20...+60 °C		
	storage	-40...+80 °C		
Mounting position	any			
Mounting on DIN rail (EN 50 022)	snap-on mounting / screw mounting with adapter			
Wire	solid wire	plug-connector with screw terminals 1.5 mm ² (16 AWG)		
size	stranded wire	plug-connector with screw terminals 2.5 mm ² (14 AWG)		
Electromagnetic compatibility				
Interference immunity	acc. to EN 61000-6-2			
electrostatic discharge (ESD)	acc. to IEC/EN 61000-4-2	level 3	±6 kV / ±8 kV	
electromagnetic field	acc. to IEC/EN 61000-4-3	10 V/m		
fast transients (Burst)	acc. to IEC/EN 61000-4-4	level 3	±2 kV / 5 kH	
powerful impulses (Surge)	acc. to IEC/EN 61000-4-5	±2 kV / ±1 kV		
HF line emission	acc. to IEC/EN 61000-4-6	10 V		
Interference emission	acc. to EN 61000-6-4	class B		

Analog signal converters

CC-E, CC-U

Dimensional drawings, Connecting terminals

Dimensions in mm

CC-E/x

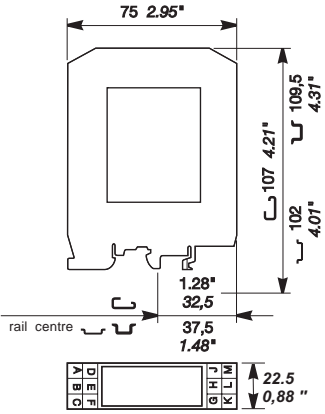

CC-E I_{AC}/ILPO, CC-E I/I

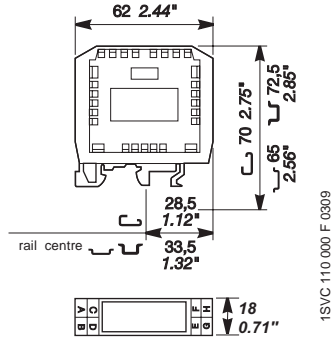

CC-U/x , CC-U/xR

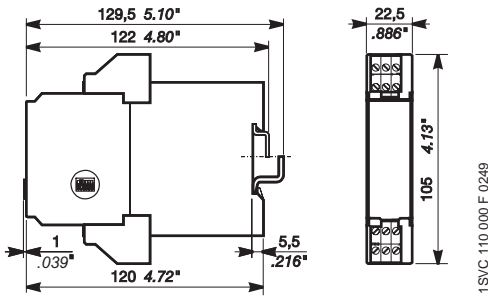

Connecting terminals CC-U/x

Width 22.5 mm / .886 "

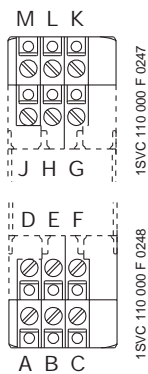

Load limit curves CC-U/xxR

Resistive AC load

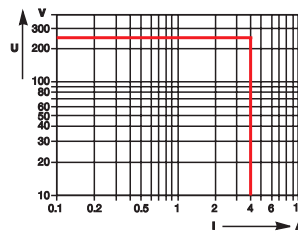

Resistive DC load

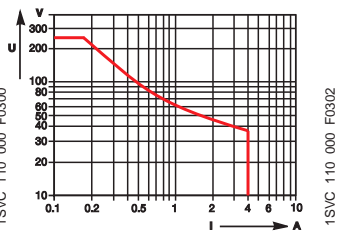

Derating curve

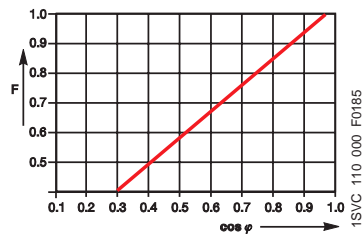



ABB Inc.
1206 Hatton Road
Wichita Falls, TX 76302
Telephone 888-385-1221; 940-397-7000
Fax 940-397-7085
<http://www.abb-control.com>

Publication
No. 1SXU 160 005 B0201 (LV005)
Printed in USA, October, 2004