

# Product datasheet

Specifications



## Miniature plug-in relay, 3 A, 4 CO, without LED, 24 V DC

RXM4LB1BD

### Main

Range of product	Harmony Electromechanical Relays
Series name	RXM series
Product or component type	Plug-in relay
Relay type	Miniature relay
Contacts type and composition	4 C/O
[Uc] control circuit voltage	24 V DC
[Ithe] conventional enclosed thermal current	3 A at -40...55 °C

### Complementary

status LED	Without
Control type	Without lockable test button
[Ie] rated operational current	1.5 A at 28 V (DC) NC conforming to IEC 1.5 A at 250 V (AC) NC conforming to IEC 3 A at 28 V (DC) NO conforming to IEC 3 A at 250 V (AC) NO conforming to IEC 3 A at 24 V (DC) NO conforming to IEC 3 A at 220 V (AC) NO conforming to IEC 3 A at 28 V (DC) conforming to UL 3 A at 250 V (AC) conforming to UL
Minimum switching capacity	25 mW subject to switching frequency, environment or expected reliability level etc
Rated operational voltage limits	19.2...26.4 V DC
[Ui] rated insulation voltage	250 V conforming to IEC
Maximum switching voltage	250 V AC 28 V DC
Drop-out voltage threshold	$\geq 0.1 U_c$ DC
Load current	3 A at 250 V AC 3 A at 28 V DC
Maximum switching capacity	750 VA AC 84 W DC
Minimum switching current	5 mA subject to switching frequency, environment or expected reliability level etc
Minimum switching voltage	5 V subject to switching frequency, environment or expected reliability level etc
Average resistance	640 Ohm at 23 °C +/- 10 %
Average coil consumption	0.9 W, DC
Mechanical durability	20000000 cycles
Electrical durability	200000 cycles resistive load 23 °C 100000 cycles resistive load at 55 °C
Safety reliability data	B10d = 100000

Excluding VAT, FCA Jabal Ali & amp; are subject to change – check with your local distributor.

<b>Operating rate</b>	<= 1200 cycles/hour under load <= 18000 cycles/hour no-load
<b>Utilisation coefficient</b>	20 %
<b>Dielectric strength</b>	2000 V AC between coil and contact with basic insulation 2000 V AC between poles with basic insulation 1000 V AC between contacts with micro disconnection
<b>Protection category</b>	RT I
<b>Pollution degree</b>	2
<b>Operating position</b>	Any position
<b>Test levels</b>	Level A group mounting
<b>Sale per indivisible quantity</b>	10
<b>Contacts material</b>	Silver alloy (Ag/Ni)
<b>Shape of pin</b>	Flat (faston type)
<b>Net weight</b>	0.033 kg

## Environment

<b>Standards</b>	CE IEC 61810-1 (iss. 2) UL 508
<b>Ambient air temperature for storage</b>	-40...85 °C
<b>Vibration resistance</b>	3 gn, amplitude = +/- 1 mm (f = 10...50 Hz)operating conforming to IEC 60068-2-6 6 gn, amplitude = +/- 1 mm (f = 10...50 Hz)not operating conforming to IEC 60068-2-6
<b>Shock resistance</b>	30 gn for not operating conforming to IEC 60068-2-27 10 gn for in operation conforming to IEC 60068-2-27

## Packing Units

<b>Unit Type of Package 1</b>	PCE
<b>Number of Units in Package 1</b>	1
<b>Package 1 Height</b>	2.2 cm
<b>Package 1 Width</b>	2.9 cm
<b>Package 1 Length</b>	4.8 cm
<b>Package 1 Weight</b>	34.0 g
<b>Unit Type of Package 2</b>	BB1
<b>Number of Units in Package 2</b>	10
<b>Package 2 Height</b>	3.1 cm
<b>Package 2 Width</b>	11.2 cm
<b>Package 2 Length</b>	13.6 cm
<b>Package 2 Weight</b>	361.0 g
<b>Unit Type of Package 3</b>	S02
<b>Number of Units in Package 3</b>	270
<b>Package 3 Height</b>	15.0 cm
<b>Package 3 Width</b>	30.0 cm
<b>Package 3 Length</b>	40.0 cm
<b>Package 3 Weight</b>	10.65 kg

# Contractual warranty

---

Warranty (in months)

18



## Environmental Data

Schneider Electric aims to achieve Net Zero status by 2050 through supply chain partnerships, lower impact materials, and circularity via our ongoing “Use Better, Use Longer, Use Again” campaign to extend product lifetimes and recyclability.

[Environmental Data explained >](#)

[How we assess product sustainability >](#)



### Environmental footprint

Total lifecycle Carbon footprint	13 kg CO2 eq.
Carbon footprint of the manufacturing phase [A1 to A3]	0.3 kg CO2 eq.
Carbon footprint of the distribution phase [A4]	0 kg CO2 eq.
Carbon footprint of the installation phase [A5]	0 kg CO2 eq.
Carbon footprint of the use phase [B2, B3, B4, B6]	13 kg CO2 eq.
Carbon footprint of the end-of-life phase [C1 to C4]	0 kg CO2 eq.
Environmental Disclosure	<a href="#">Product Environmental Profile</a>

## Use Better



### Materials and Substances

Packaging made with recycled cardboard	Yes
Packaging without single use plastic	Yes
EU RoHS Directive	<a href="#">Compliant</a>
REACH Regulation	<a href="#">Free of Substances of Very High Concern above the threshold</a>

## Use Longer



### Lifetime extension

Repair	No
--------	----

## Use Again



### Repack and remanufacture

End of life manual availability	<a href="#">End of Life Information</a>
Take-back	No
WEEE Label	 The product must be disposed on European Union markets following specific waste collection and never end up in rubbish bins

Dimensions Drawings

Dimensions

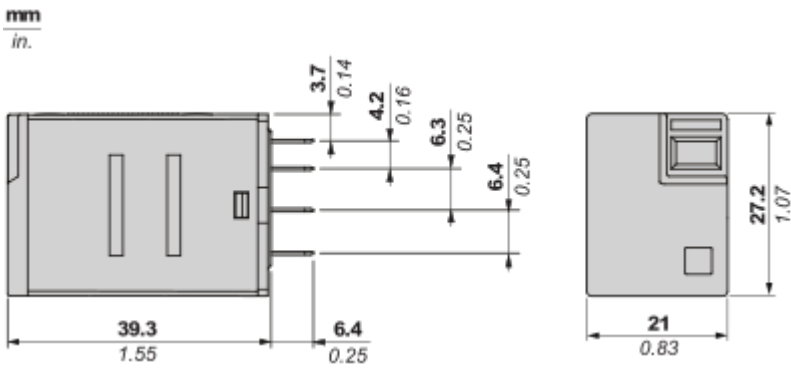

Pin Side View

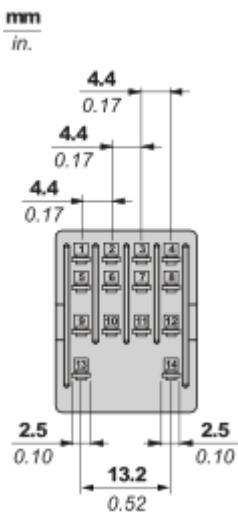

Connections and Schema

Wiring Diagram

---

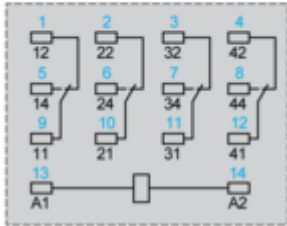
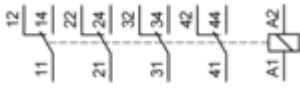

Symbols shown in blue correspond to Nema marking.

Performance Curves

Electrical Durability of Contacts

---

**Durability (inductive load) = durability (resistive load) x reduction coefficient.**

For 4 Poles Relay

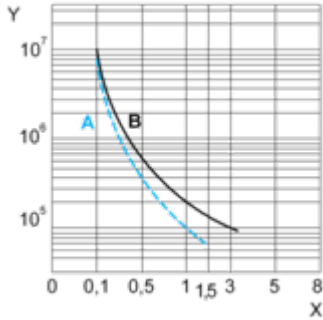

**X** : Contact current (A)

**Y** : Durability (Number of operating cycles)

**A** : Inductive load

**B** : Resistive load

**Note** : These are typical curves, actual durability depends on load, environment, duty cycle, etc.

For inductive load, to increase relay life cycles, please add a proper load protection circuit (eg: RC protection/Varistor/free Wheeling diode -DC load only- )

**Maximum Switching Capacity**

---

For 4 Poles Relay

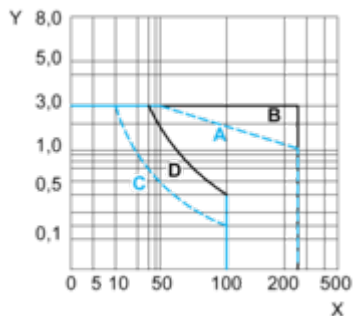

**X** : Contact voltage (v)

**Y** : Contact current (A)

**A** : Inductive AC load

**B** : Resistive AC load

**C** : Inductive DC load

**D** : Resistive DC load

**Note** : These are typical curves, actual durability depends on load, environment, duty cycle, etc.

For inductive load, to increase relay life cycles, please add a proper load protection circuit (eg: RC protection/Varistor/free Wheeling diode -DC load only- )

For low level loads (below 10mA), we recommend to use RXM\*GB series with bifurcated contacts relays instead.

Technical Illustration

Dimensions

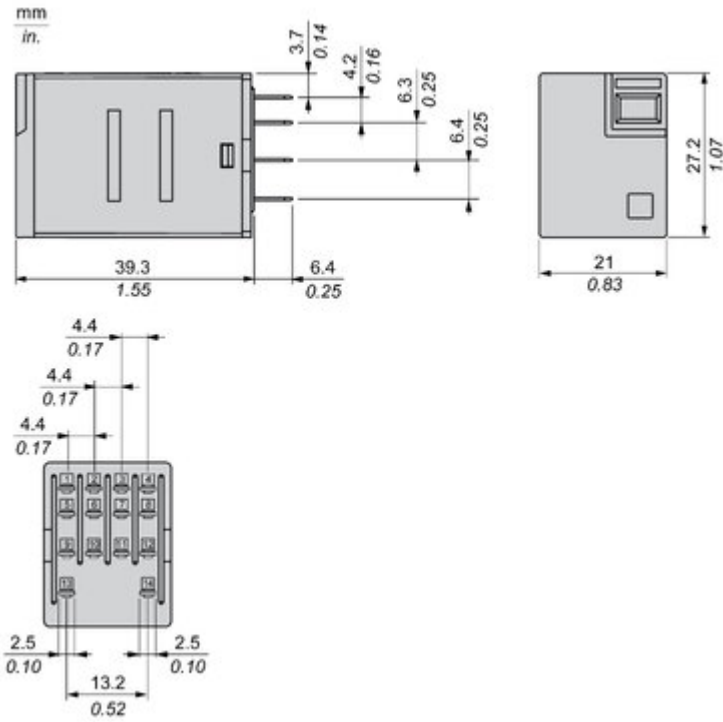

Offer Marketing Illustration

Product benefits / Features

---

## Features

Easy Harmony RXMLB Relay



Fit to customer needs  
coverage of most general  
control panel applications



Easy to select  
simple selection and  
wide availability





Convenient to use  
Easy status readiness  
through mechanical  
indicator & LED



Safe to perform  
product reliability,  
compliance with  
industrial standard  
and eco-design

Offer Marketing Illustration

Product benefits / Features

---

## Technical Benefits

### Easy Harmony RXMLB Relay

RXM\*LB sockets:

- Mixed contact arrangement
- Screw clamp terminal

Metal maintaining clamp:  
reliable in vibration  
environment

Finger grip cover to  
easily remove relay  
from socket



RXM\*LB sockets:

- 2CO-5A, 4CO-3A
- 12-110VDC, 24-230VAC

Mechanical indicator  
for contact status

"Power On" LED for  
relays status

Image of product / Alternate images

Alternative

---

