

Pump control panel, NEMA Size 2, Three phase full voltage, 50A motor circuit protector, Solid-state overload relay, OLR amp range 13-52A, 600 V AC 60Hz coil, HOA selector switch, Start push button, Enclosure NEMA type 3R, Weather proof outdoor use, Standards: UL 60947-1, Certifications: cULus, Listed Service Entrance Equip



design of the product	Pump control panel with MCP
special product feature	ESP200 overload relay
General technical data	
Height x Width x Depth [in]	29 × 20 × 8 in
touch protection against electrical shock	NA for enclosed products
country of origin	Mexico
Contactor	
size of contactor	NEMA controller size 2
number of NO contacts for main contacts	3
operating voltage for main current circuit at AC at 60 Hz maximum	600 V
Auxiliary contact	
contact rating of auxiliary contacts of contactor according to UL	10A@600VAC (A600), 5A@600VDC (P600)
Coil	
type of voltage of the control supply voltage	AC
Overload relay	
product function	
• overload protection	Yes
• phase failure detection	Yes
• asymmetry detection	Yes
• ground fault detection	Yes
• test function	Yes
• external reset	Yes
reset function	Manual, automatic and remote
trip class	CLASS 5 / 10 (factory set) / 20 / 30
product feature protective coating on printed-circuit board	Yes
contact rating of auxiliary contacts of overload relay according to UL	5A@600VAC (B600), 1A@250VDC (R300)
Enclosure	
degree of protection NEMA rating of the enclosure	NEMA Type 3R
design of the housing	Weather proof for outdoor use
Standard Control Devices	
product component Hand-Off-Auto selector switch	Yes
type of Hand-Off-Auto selector switch	30mm metal housing with matte finish
product component start push button	Yes
type of start push button	30mm metal housing with matte finish
Circuit Breaker	
type of the motor protection	Motor circuit protector (magnetic trip only)
Mounting/wiring	

mounting position	Vertical
fastening method	Surface mounting and installation
type of electrical connection for supply voltage line-side	Box lug
type of connectable conductor cross-sections at line-side for AWG cables single or multi-stranded	1x (10 AWG ... 1/0 AWG)
material of the conductor for supply	AL or CU
type of electrical connection for load-side outgoing feeder	Screw-type terminals
type of connectable conductor cross-sections for AWG cables for load-side outgoing feeder single or multi-stranded	2x (18 ... 2 AWG), 1x (18 ... 1 AWG)
material of the conductor for load-side outgoing feeder	CU
type of electrical connection of magnet coil	Screw-type terminals
type of connectable conductor cross-sections of magnet coil for AWG cables single or multi-stranded	2x (20 ... 16 AWG), 2x (18 ... 14 AWG)
material of the conductor at magnet coil	CU
type of electrical connection at contactor for auxiliary contacts	Screw-type terminals
type of connectable conductor cross-sections at contactor for AWG cables for auxiliary contacts single or multi-stranded	2x (20 ... 16 AWG), 2x (18 ... 14 AWG)
material of the conductor at contactor for auxiliary contacts	CU
type of electrical connection at overload relay for auxiliary contacts	Screw-type terminals
type of connectable conductor cross-sections at overload relay for AWG cables for auxiliary contacts single or multi-stranded	2x (20 ... 14 AWG)
material of the conductor at overload relay for auxiliary contacts	CU

Short-circuit current rating

design of the short-circuit trip	Instantaneous trip circuit breaker
certificate of suitability	NEMA ICS 2; UL 508

Approvals Certificates

General Product Approval	Test Certificates	other	Environment
--------------------------	-------------------	-------	-------------



[Confirmation](#)



[Environmental Confirmations](#)

Further information

Industrial Controls - Product Overview (Catalogs, Brochures,...)

www.usa.siemens.com/iccatalog

Industry Mall (Online ordering system)

<https://mall.industry.siemens.com/mall/en/us/Catalog/product?mlfb=3RE4812-0GM86-4FA0>

Service&Support (Manuals, Certificates, Characteristics, FAQs,...)

<https://support.industry.siemens.com/cs/US/en/ps/3RE4812-0GM86-4FA0>

Image database (product images, 2D dimension drawings, 3D models, device circuit diagrams, EPLAN macros, ...)

https://www.automation.siemens.com/bilddb/cax_de.aspx?mlfb=3RE4812-0GM86-4FA0&lang=en

Certificates/approvals

<https://support.industry.siemens.com/cs/US/en/ps/3RE4812-0GM86-4FA0/certificate>

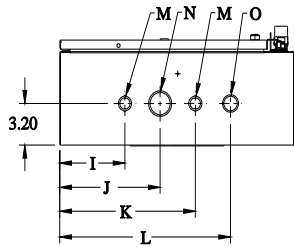
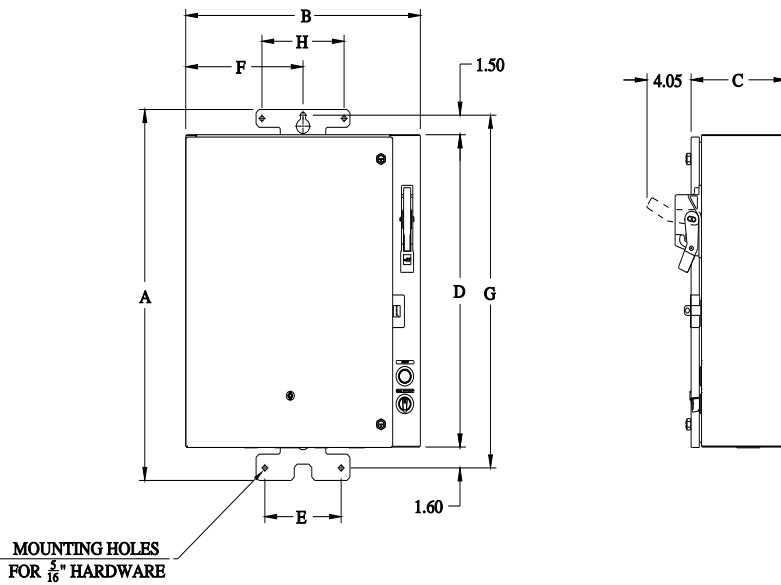

OUTLINE DIMENSIONS						
A	B	C				
28.50	20.00	8.06				
MOUNTING DIMENSIONS						
D	E	F	G	H		
24.00	6.50	10.00	27.10	7.00		
CONDUIT KNOCKOUTS						
I	J	K	L	M	N	O
5.50	8.50	11.50	14.50	1.12-875	1.96-1.71	1.35-1.12

A5E51602383A/E87010A0546-T005-A4

last modified:

10/22/2025