



Miniature circuit breaker 400 V 15kA, 2-pole, D, 8A

Model	
product brand name	SENTRON
product designation	Miniature circuit breaker
General technical data	
number of poles	2
design of pole	2P
tripping characteristic class	D
mechanical service life (operating cycles) typical	10 000
overvoltage category	3
degree of pollution	3
Voltage	
type of voltage of the operating voltage	AC
insulation voltage (Ui)	
• with multi-phase operation at AC rated value	440 V
• operational current	
— at 40 °C rated value	7.11 A
— at 50 °C rated value	6.1 A
— at 55 °C rated value	5.53 A
• operational current at AC rated value	8 A
Supply voltage	
supply voltage	
• at AC	400 V
• at DC rated value	60 V
value range of the supply voltage frequency	50/60 Hz
operating voltage at DC rated value maximum	72 V
Protection class	
protection class IP	IP20, with connected conductors
Breaking Capacity	
switching capacity current	
• according to IEC 60947-2 rated value	25 kA
Dissipation	
power loss [W] for rated value of the current at AC in hot operating state per pole	1.1 W
suitability for operation	Infrastructure / Industry
Product details	
product feature touch protection	Yes
product component	
• combined terminal top	Yes

• combined terminal bottom	Yes
• neutral conductor switching	No
<b>product feature properties for main switches in accordance with EN 60204-1</b>	Yes
<b>product feature halogen-free</b>	Yes
<b>product feature sealable</b>	Yes
<b>product feature silicon-free</b>	Yes
<b>product extension installable supplementary devices</b>	Yes

### Connections

<b>connectable conductor cross-section solid</b>	
• minimum	0.75 mm <sup>2</sup>
• maximum	35 mm <sup>2</sup>
<b>connectable conductor cross-section stranded</b>	
• minimum	0.75 mm <sup>2</sup>
• maximum	35 mm <sup>2</sup>
<b>connectable conductor cross-section finely stranded with core end processing</b>	
• minimum	0.75 mm <sup>2</sup>
• maximum	25 mm <sup>2</sup>
<b>tightening torque [lbf-in] with screw-type terminals</b>	
• minimum	22 lbf-in
• maximum	31 lbf-in
<b>tightening torque with screw-type terminals</b>	
• minimum	2.5 N·m
• maximum	3.5 N·m
<b>position of power supply cord</b>	Any

### Mechanical Design

<b>height</b>	90 mm
<b>width</b>	36 mm
<b>depth</b>	76 mm
<b>installation depth</b>	70 mm
<b>number of modular width units</b>	2
<b>fastening method</b>	DIN rail
<b>mounting position</b>	any
<b>Net Weight</b>	0.32 kg

### Environmental conditions

<b>influence of the surrounding temperature</b>	max. 95% RH up to 55°C
<b>standard</b>	IEC / EN 60947-2
<b>vibration resistance according to IEC 60068-2-6</b>	±1mm at 5 to 25 Hz; 50 m/s <sup>2</sup> at 25 to 150 Hz and 60 m/s <sup>2</sup> at 35 Hz (4 sec)
<b>ambient temperature during operation</b>	
• minimum	-25 °C
• maximum	55 °C
<b>ambient temperature during storage</b>	
• minimum	-40 °C
• maximum	75 °C
<b>number of test cycles for environmental testing according to IEC 60068-2-30</b>	28

### Approvals Certificates

<b>Environment</b>	<b>General Product Approval</b>
--------------------	---------------------------------

[Environmental Con-  
firmations](#)

[Environmental Con-  
firmations](#)



[Miscellaneous](#)



<b>General Product Approval</b>	<b>Maritime application</b>	<b>other</b>
---------------------------------	-----------------------------	--------------

## Railway

[Confirmation](#)

## Further information

## Information on the packaging

<https://support.industry.siemens.com/cs/ww/en/view/109813875>

## Information for data generation and storage

<https://support.industry.siemens.com/cs/ww/en/view/109995012>

## Information- and Downloadcenter (Catalogs, Brochures,...)

<https://www.siemens.com/lowvoltage/catalogs>

## Industry Mall (Online ordering system)

<https://mall.industry.siemens.com/mall/en/en/Catalog/product?mlfb=5SY7208-8CC>

## Service&amp;Support (Manuals, Certificates, Characteristics, FAQs,...)

<https://support.industry.siemens.com/cs/ww/en/ps/5SY7208-8CC>

## Image database (product images, 2D dimension drawings, 3D models, device circuit diagrams, ...)

[https://www.automation.siemens.com/bilddb/cax\\_en.aspx?mlfb=5SY7208-8CC](https://www.automation.siemens.com/bilddb/cax_en.aspx?mlfb=5SY7208-8CC)

## CAx-Online-Generator

<https://www.siemens.com/cax>

## Tender specifications

<https://www.siemens.com/specifications>

## Characteristic curves

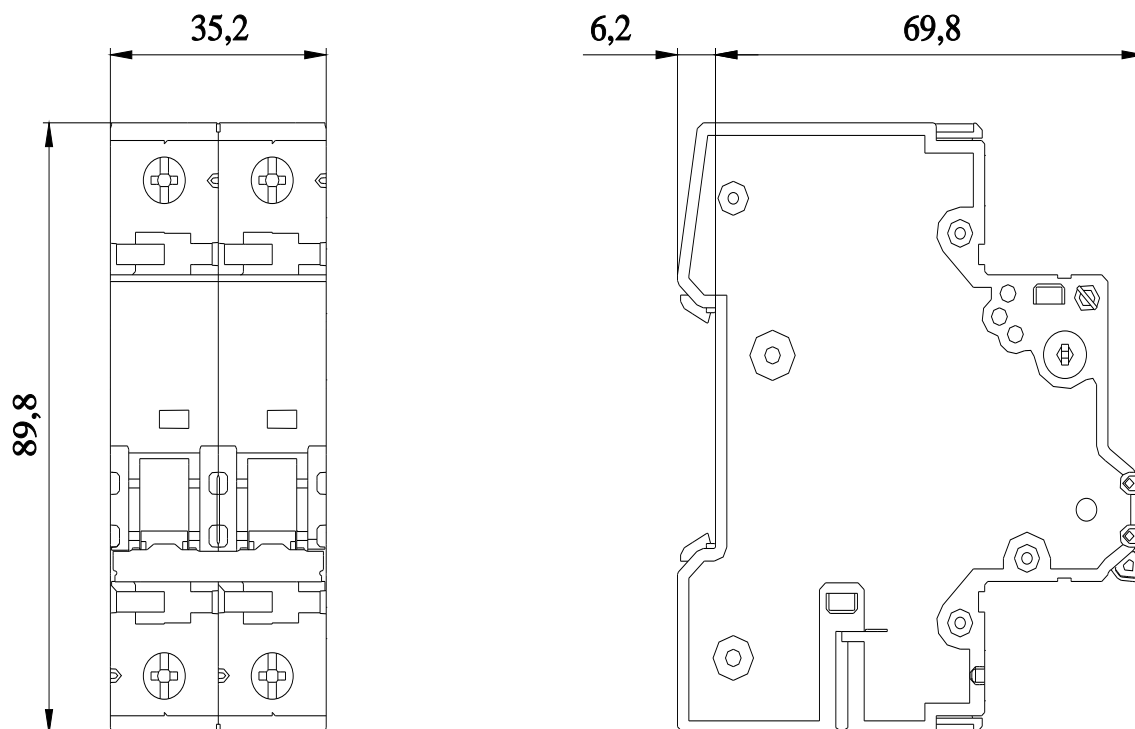
[https://curves.simaris.siemens.com/curves/<mmp\\_prod\\_noCOMP="HAUPT"></mmp\\_prod\\_no>](https://curves.simaris.siemens.com/curves/<mmp_prod_noCOMP=)



CB



last modified:

9/12/2025 

