

Product datasheet

Specifications



2-phase stepper motor - 1.69 N.m -
shaft Ø6.35 mm - L=76mm - without
brake- 2.4A

BRS2573A240

ⓘ Discontinued

Disclaimer: This documentation is not intended as a substitute for and is not to be used for determining suitability or reliability of these products for specific user applications



Environmental Data

Schneider Electric aims to achieve Net Zero status by 2050 through supply chain partnerships, lower impact materials, and circularity via our ongoing “Use Better, Use Longer, Use Again” campaign to extend product lifetimes and recyclability.

[Environmental Data explained >](#)

[How we assess product sustainability >](#)

Use Longer



Lifetime extension

Repair

No

Dimensions Drawings

Dimensions

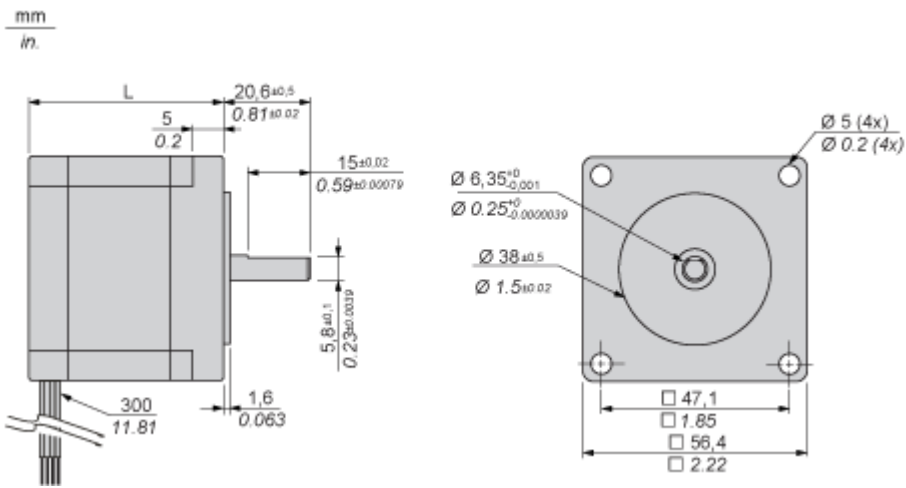

Dimensions in mm

L
76

Dimensions in in.

L
2.99

Performance Curves

Torque Characteristics

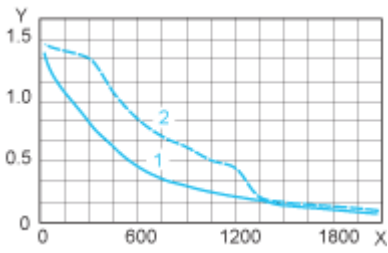

X : Speed of rotation in rpm

Y : Torque in Nm

1 : 24 VDC

2 : 48 VDC