



## Main

Range of Product	Telemecanique Limit switches XC Standard
Series name	Standard format
Product or Component Type	Limit switch
Device short name	XCKD
Sensor design	Compact
Body type	Fixed
Head type	M18 plunger head
Material	Metal
Fixing Mode	By the head
Movement of operating head	Linear
Type of operator	Spring return plunger metal
Switch actuation	On end
Type of approach	Vertical approach, 1 direction
Electrical connection	Screw-clamp terminals 1 x 0.34...2 x 0.75 mm <sup>2</sup>
Cable entry number	1 tapped entry M16 x 1.5 cable gland (included) 0.16...0.31 in (4...8 mm)
Number of poles	3
Contacts type and composition	2 NC + 1 NO
Contacts insulation form	Zb
Contact operation	Snap action
Number of steps	1
Positive opening	With
Minimum force for tripping	15 N
Maximum actuation speed	1.64 ft/s (0.5 m/s)
IP degree of protection	IP66 conforming to IEC 60529 IP67 conforming to IEC 60529

## Complementary

Body Material	Zamak
Head material	Zamak
Positive opening minimum force	45 N
Minimum actuation speed	0.01 m/min
Contact code designation	B300, AC-15 (U <sub>e</sub> = 240 V), I <sub>e</sub> = 1.5 A EN 60947-5-1 B300, AC-15 (U <sub>e</sub> = 240 V), I <sub>e</sub> = 1.5 A IEC 60947-5-1 appendix A R300, DC-13 (U <sub>e</sub> = 250 V), I <sub>e</sub> = 0.1 A EN 60947-5-1 R300, DC-13 (U <sub>e</sub> = 250 V), I <sub>e</sub> = 0.1 A IEC 60947-5-1 appendix A
[I <sub>th</sub> e] conventional enclosed thermal current	6 A AC
[U <sub>i</sub> ] rated insulation voltage	300 VUL 508 400 V 3)IEC 60947-1 300 VCSA C22.2 No 14
Maximum resistance across terminals	25 MOhm IEC 60255-7 category 3
[U <sub>imp</sub> ] rated impulse withstand voltage	4 KV IEC 60664 4 kV IEC 60947-1
Short-circuit protection	6 A cartridge fuse gG

Electrical durability	5000000 Cycles, DC-13, inductive, 120 V, 2 W 3600 cyc/mn 0.5, DC IEC 60947-5-1 appendix C 5000000 Cycles, DC-13, inductive, 24 V, 4 W 3600 cyc/mn 0.5, DC IEC 60947-5-1 appendix C 5000000 cycles, DC-13, inductive, 48 V, 3 W 3600 cyc/mn 0.5, DC IEC 60947-5-1 appendix C
Mechanical durability	10000000 cycles
Marking	II2 D-Ex tb IIIC T85°C Db IP66/67
Width	1.22 in (31 mm)
Height	2.56 in (65 mm)
Depth	1.18 in (30 mm)

## Environment

Shock resistance	50 gn 11 ms IEC 60068-2-27
Vibration resistance	25 gn 10...500 Hz)IEC 60068-2-6
Electrical shock protection class	Class I IEC 61140 Class I NF C 20-030
Ambient Air Temperature for Operation	-4...140 °F (-20...60 °C)
Protective treatment	TC
Dust zone	Zone 21 - 22
Product Certifications	INERIS 04ATEX0014X IEC-Ex INE 17.0020X
Standards	EN/IEC 60079-31 EN/IEC 60079-0
Directives	2014/34/EU - ATEX directive

## Ordering and shipping details

Category	22418-LIMIT SWITCH,IEC,XCKP&XCKT
Discount Schedule	T
GTIN	3389118027480
Nbr. of units in pkg.	1
Package weight(Lbs)	7.44 oz (211.0 g)
Returnability	No
Country of origin	FR

## Packing Units

Unit Type of Package 1	PCE
Package 1 Height	5.91 in (15.0 cm)
Package 1 width	5.51 in (14.0 cm)
Package 1 Length	1.97 in (5.0 cm)
Unit Type of Package 2	CAR
Number of Units in Package 2	1
Package 2 Weight	7.44 oz (211.0 g)
Package 2 Height	1.97 in (5.0 cm)
Package 2 width	1.57 in (4.0 cm)
Package 2 Length	5.51 in (14.0 cm)

## Offer Sustainability

Sustainable offer status	Green Premium product
California proposition 65	WARNING: This product can expose you to chemicals including: Diisononyl phthalate (DINP), which is known to the State of California to cause cancer, and Di-isodecyl phthalate (DIDP), which is known to the State of California to cause birth defects or other reproductive harm. For more information go to <a href="http://www.P65Warnings.ca.gov">www.P65Warnings.ca.gov</a>
REACH Regulation	<a href="#">REACH Declaration</a>
EU RoHS Directive	Pro-active compliance (Product out of EU RoHS legal scope) <a href="#">EU RoHS Declaration</a>
Mercury free	Yes

---

RoHS exemption information	 Yes
Environmental Disclosure	 <a href="#">Product Environmental Profile</a>

---

**Contractual warranty**

---

Warranty	18 months
----------	-----------

---

Dimensions

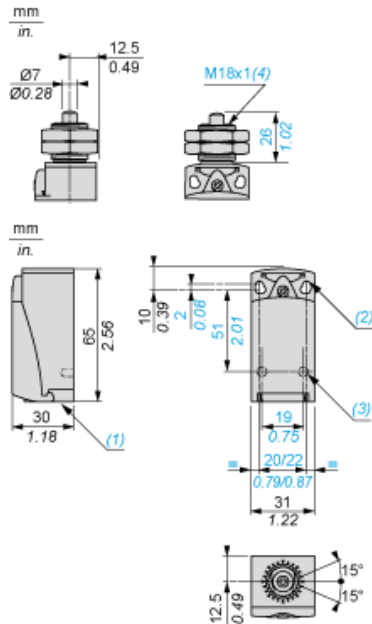

- (1) Tapped entry for M16 x 1.5
- (2) 2 elongated holes  $\varnothing 4.3 \times 6.3$  mm on 22 mm centres, 2 holes  $\varnothing 4.3$  on 20 mm centres.
- (3) 2 x  $\varnothing 3$  holes for support studs, depth 4 mm.
- (4) Fixing nut thickness 3.5 mm.

---

### Mounting with Cable Entry

---

#### Position of Cable Gland

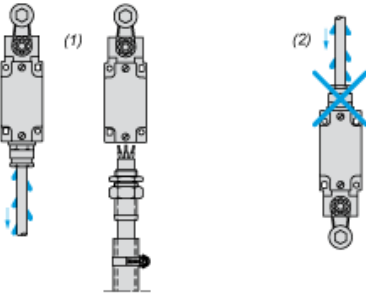

- (1) Recommended
- (2) To be avoided

---

### Panel Mounting

---

#### Mounting and Fixing Limit Switches by the Head

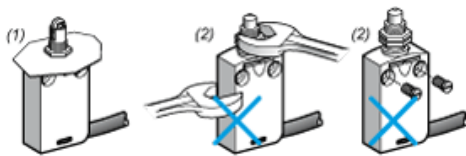

- (1) Recommended
- (2) Forbidden

---

### Setting-up

---

#### Plunger or Multi-directional Heads

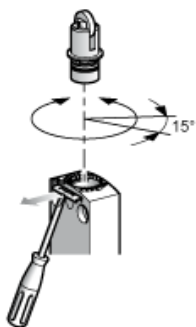

---

## Wiring Diagram

---

3-pole NC + NC + NO Snap Action

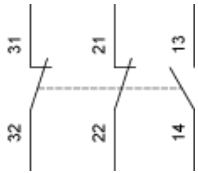

Characteristics of Actuation

Switch Actuation on End

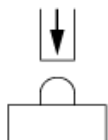

Functionnal Diagram

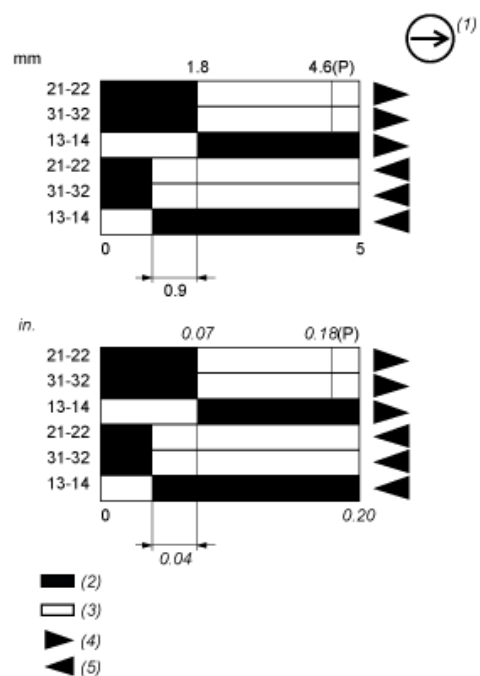

- (P) Positive opening point
- (1) NC contact with positive opening operation
- (2) Closed
- (3) Open
- (4) Tripping
- (5) Resetting