

power contactor, AC-3e/AC-3, 17 A, 7.5 kW / 400 V, 3-pole, 400 V AC, 50 Hz, auxiliary contacts: 1 NO + 1 NC, screw terminal, size: S0

















product brand name	SIRIUS
product designation	Power contactor
product type designation	3RT2
General technical data	
size of contactor	S0
product extension	
• function module for communication	No
• auxiliary switch	Yes
power loss [W] for rated value of the current	
• at AC in hot operating state	1.8 W
• at AC in hot operating state per pole	0.6 W
• without load current share typical	1.9 W
type of calculation of power loss current-dependent	quadratic
insulation voltage	
• of main circuit with degree of pollution 3 rated value	690 V
• of auxiliary circuit with degree of pollution 3 rated value	690 V
surge voltage resistance	
• of main circuit rated value	6 kV
• of auxiliary circuit rated value	6 kV
maximum permissible voltage for protective separation between coil and main contacts according to EN 60947-1	400 V
shock resistance at rectangular impulse	
• at AC	7,5 g / 5 ms, 4,7 g / 10 ms
shock resistance with sine pulse	
• at AC	11,8 g / 5 ms, 7,4 g / 10 ms
mechanical service life (operating cycles)	
• of contactor typical	10 000 000
• of the contactor with added electronically optimized auxiliary switch block typical	5 000 000
• of the contactor with added auxiliary switch block typical	10 000 000
reference code according to IEC 81346-2	Q
Substance Prohibition (day/month/year)	10/01/2009
Net Weight	0.401 g
Ambient conditions	
installation altitude at height above sea level maximum	2 000 m
ambient temperature	
• during operation	-25 ... +60 °C
• during storage	-55 ... +80 °C
relative humidity minimum	10 %
relative humidity at 55 °C according to IEC 60068-2-30 maximum	95 %
Main circuit	
number of poles for main current circuit	3
number of NO contacts for main contacts	3
number of NC contacts for main contacts	0
operating voltage	
• at AC-3 rated value maximum	690 V
• at AC-3e rated value maximum	690 V
operational current	
• at AC-1 at 400 V at ambient temperature 40 °C rated	40 A

value	
<ul style="list-style-type: none"> ● at AC-1 <ul style="list-style-type: none"> — up to 690 V at ambient temperature 40 °C rated value 40 A — up to 690 V at ambient temperature 60 °C rated value 35 A ● at AC-3 <ul style="list-style-type: none"> — at 400 V rated value 17 A — at 500 V rated value 17 A — at 690 V rated value 13 A ● at AC-3e <ul style="list-style-type: none"> — at 400 V rated value 17 A — at 500 V rated value 17 A — at 690 V rated value 13 A ● at AC-4 at 400 V rated value 15.5 A ● at AC-5a up to 690 V rated value 35.2 A ● at AC-5b up to 400 V rated value 14.1 A ● at AC-6a <ul style="list-style-type: none"> — up to 230 V for current peak value n=20 rated value 11.4 A — up to 400 V for current peak value n=20 rated value 11.4 A — up to 500 V for current peak value n=20 rated value 11.4 A — up to 690 V for current peak value n=20 rated value 11.3 A ● at AC-6a <ul style="list-style-type: none"> — up to 230 V for current peak value n=30 rated value 7.6 A — up to 400 V for current peak value n=30 rated value 7.6 A — up to 500 V for current peak value n=30 rated value 7.6 A — up to 690 V for current peak value n=30 rated value 7.6 A 	
minimum cross-section in main circuit at maximum AC-1 rated value	10 mm ²
operational current for approx. 200000 operating cycles at AC-4	
<ul style="list-style-type: none"> ● at 400 V rated value 7.7 A ● at 690 V rated value 7.7 A 	
operational current	
<ul style="list-style-type: none"> ● at 1 current path at DC-1 <ul style="list-style-type: none"> — at 24 V rated value 35 A — at 60 V rated value 20 A — at 110 V rated value 4.5 A — at 220 V rated value 1 A — at 440 V rated value 0.4 A — at 600 V rated value 0.25 A ● with 2 current paths in series at DC-1 <ul style="list-style-type: none"> — at 24 V rated value 35 A — at 60 V rated value 35 A — at 110 V rated value 35 A — at 220 V rated value 5 A — at 440 V rated value 1 A — at 600 V rated value 0.8 A ● with 3 current paths in series at DC-1 <ul style="list-style-type: none"> — at 24 V rated value 35 A — at 60 V rated value 35 A — at 110 V rated value 35 A — at 220 V rated value 35 A — at 440 V rated value 2.9 A — at 600 V rated value 1.4 A ● at 1 current path at DC-3 at DC-5 <ul style="list-style-type: none"> — at 24 V rated value 20 A — at 60 V rated value 5 A — at 220 V rated value 1 A — at 440 V rated value 0.09 A 	

<ul style="list-style-type: none"> — at 600 V rated value 	0.06 A
<ul style="list-style-type: none"> ● with 2 current paths in series at DC-3 at DC-5 <ul style="list-style-type: none"> — at 24 V rated value — at 60 V rated value — at 110 V rated value — at 220 V rated value — at 440 V rated value — at 600 V rated value ● with 3 current paths in series at DC-3 at DC-5 <ul style="list-style-type: none"> — at 24 V rated value — at 60 V rated value — at 110 V rated value — at 220 V rated value — at 440 V rated value — at 600 V rated value 	35 A 35 A 15 A 3 A 0.27 A 0.16 A 35 A 35 A 35 A 10 A 0.6 A 0.6 A
operating power <ul style="list-style-type: none"> ● at AC-3 <ul style="list-style-type: none"> — at 230 V rated value — at 400 V rated value — at 500 V rated value — at 690 V rated value ● at AC-3e <ul style="list-style-type: none"> — at 230 V rated value — at 400 V rated value — at 500 V rated value — at 690 V rated value 	4 kW 7.5 kW 7.5 kW 11 kW 4 kW 7.5 kW 7.5 kW 11 kW
operating power for approx. 200000 operating cycles at AC-4 <ul style="list-style-type: none"> ● at 400 V rated value ● at 690 V rated value 	3.5 kW 6 kW
operating apparent power at AC-6a <ul style="list-style-type: none"> ● up to 230 V for current peak value n=20 rated value ● up to 400 V for current peak value n=20 rated value ● up to 500 V for current peak value n=20 rated value ● up to 690 V for current peak value n=20 rated value 	4.5 kVA 7.8 kVA 9.9 kVA 13.6 kVA
operating apparent power at AC-6a <ul style="list-style-type: none"> ● up to 230 V for current peak value n=30 rated value ● up to 400 V for current peak value n=30 rated value ● up to 500 V for current peak value n=30 rated value ● up to 690 V for current peak value n=30 rated value 	3 kVA 5.2 kVA 6.6 kVA 9.1 kVA
short-time withstand current in cold operating state up to 40 °C <ul style="list-style-type: none"> ● limited to 1 s switching at zero current maximum ● limited to 5 s switching at zero current maximum ● limited to 10 s switching at zero current maximum ● limited to 30 s switching at zero current maximum ● limited to 60 s switching at zero current maximum 	225 A; Use minimum cross-section acc. to AC-1 rated value 225 A; Use minimum cross-section acc. to AC-1 rated value 189 A; Use minimum cross-section acc. to AC-1 rated value 140 A; Use minimum cross-section acc. to AC-1 rated value 115 A; Use minimum cross-section acc. to AC-1 rated value
no-load switching frequency <ul style="list-style-type: none"> ● at AC 	5 000 1/h
operating frequency <ul style="list-style-type: none"> ● at AC-1 maximum ● at AC-2 maximum ● at AC-3 maximum ● at AC-3e <ul style="list-style-type: none"> — maximum ● at AC-4 maximum 	1 000 1/h 1 000 1/h 1 000 1/h 1 000 1/h 300 1/h
Control circuit/ Control	
type of voltage of the control supply voltage	AC
control supply voltage at AC	

• at 50 Hz rated value	400 V
operating range factor control supply voltage rated value of magnet coil at AC	
• at 50 Hz	0.8 ... 1.1
apparent pick-up power of magnet coil at AC	
• at 50 Hz	65 VA
inductive power factor with closing power of the coil	
• at 50 Hz	0.82
apparent holding power of magnet coil at AC	
• at 50 Hz	7.6 VA
inductive power factor with the holding power of the coil	
• at 50 Hz	0.25
closing delay	
• at AC	8 ... 40 ms
opening delay	
• at AC	4 ... 16 ms
arcing time	10 ms
control version of the switch operating mechanism	Standard A1 - A2
Auxiliary circuit	
number of NC contacts for auxiliary contacts instantaneous contact	1
number of NO contacts for auxiliary contacts instantaneous contact	1
operational current at AC-12 maximum	10 A
operational current at AC-15	
• at 230 V rated value	10 A
• at 400 V rated value	3 A
• at 500 V rated value	2 A
• at 690 V rated value	1 A
operational current at DC-12	
• at 24 V rated value	10 A
• at 48 V rated value	6 A
• at 60 V rated value	6 A
• at 110 V rated value	3 A
• at 125 V rated value	2 A
• at 220 V rated value	1 A
• at 600 V rated value	0.15 A
operational current at DC-13	
• at 24 V rated value	10 A
• at 48 V rated value	2 A
• at 60 V rated value	2 A
• at 110 V rated value	1 A
• at 125 V rated value	0.9 A
• at 220 V rated value	0.3 A
• at 600 V rated value	0.1 A
contact reliability of auxiliary contacts	1 faulty switching per 100 million (17 V, 1 mA)
UL/CSA ratings	
full-load current (FLA) for 3-phase AC motor	
• at 480 V rated value	14 A
• at 600 V rated value	17 A
yielded mechanical performance [hp]	
• for single-phase AC motor	
— at 110/120 V rated value	1 hp
— at 230 V rated value	3 hp
• for 3-phase AC motor	
— at 200/208 V rated value	3 hp
— at 220/230 V rated value	5 hp
— at 460/480 V rated value	10 hp
— at 575/600 V rated value	15 hp
contact rating of auxiliary contacts according to UL	A600 / P600

UL File Number (CCN)	E31519 (NLDX, NLDX7)
Short-circuit protection	
design of the miniature circuit breaker for short-circuit protection of the auxiliary circuit up to 230 V	C characteristic: 10 A; 0.4 kA
design of the fuse link	
<ul style="list-style-type: none"> ● for short-circuit protection of the main circuit <ul style="list-style-type: none"> — with type of coordination 1 required — with type of coordination 2 required ● for short-circuit protection of the auxiliary switch required 	gG: 63 A (690 V, 100 kA), aM: 32 A (690 V, 100 kA), BS88: 63 A (415 V, 80 kA) gG: 25 A (690 V, 100 kA), aM: 20 A (690 V, 100 kA), BS88: 25 A (415 V, 80 kA) gG: 10 A (500 V, 1 kA)
Installation/ mounting/ dimensions	
mounting position	+/-180° rotation possible on vertical mounting surface; can be tilted forward and backward by +/- 22.5° on vertical mounting surface
fastening method side-by-side mounting	Yes
fastening method	screw and snap-on mounting onto 35 mm DIN rail according to DIN EN 60715
height	85 mm
width	45 mm
depth	97 mm
required spacing	
<ul style="list-style-type: none"> ● with side-by-side mounting <ul style="list-style-type: none"> — forwards — upwards — downwards — at the side ● for grounded parts <ul style="list-style-type: none"> — forwards — upwards — at the side — downwards ● for live parts <ul style="list-style-type: none"> — forwards — upwards — downwards — at the side 	10 mm 10 mm 10 mm 0 mm 10 mm 10 mm 6 mm 10 mm 10 mm 10 mm 10 mm 6 mm
Connections/ Terminals	
type of electrical connection	
<ul style="list-style-type: none"> ● for main current circuit ● for auxiliary and control circuit ● at contactor for auxiliary contacts ● of magnet coil 	screw-type terminals screw-type terminals Screw-type terminals Screw-type terminals
type of connectable conductor cross-sections	
<ul style="list-style-type: none"> ● for main contacts <ul style="list-style-type: none"> — solid — solid or stranded — finely stranded with core end processing ● for AWG cables for main contacts 	2x (1 ... 2.5 mm ²), 2x (2.5 ... 10 mm ²) 2x (1 ... 2.5 mm ²), 2x (2.5 ... 10 mm ²) 2x (1 ... 2.5 mm ²), 2x (2.5 ... 6 mm ²), 1x 10 mm ² 2x (16 ... 12), 2x (14 ... 8)
connectable conductor cross-section for main contacts	
<ul style="list-style-type: none"> ● solid ● stranded ● finely stranded with core end processing 	1 ... 10 mm ² 1 ... 10 mm ² 1 ... 10 mm ²
connectable conductor cross-section for auxiliary contacts	
<ul style="list-style-type: none"> ● solid or stranded ● finely stranded with core end processing 	0.5 ... 2.5 mm ² 0.5 ... 2.5 mm ²
type of connectable conductor cross-sections	
<ul style="list-style-type: none"> ● for auxiliary contacts <ul style="list-style-type: none"> — solid or stranded — finely stranded with core end processing ● for AWG cables for auxiliary contacts 	2x (0.5 ... 1.5 mm ²), 2x (0.75 ... 2.5 mm ²) 2x (0.5 ... 1.5 mm ²), 2x (0.75 ... 2.5 mm ²) 2x (20 ... 16), 2x (18 ... 14)
AWG number as coded connectable conductor cross section for main contacts	16 ... 8
AWG number as coded connectable conductor cross	20 ... 14

section for auxiliary contacts					
Safety related data					
product function					
• mirror contact according to IEC 60947-4-1	Yes				
• positively driven operation according to IEC 60947-5-1	No				
• suitable for safety function	Yes				
suitability for use safety-related switching OFF	Yes				
service life maximum	20 a				
test wear-related service life necessary	Yes				
proportion of dangerous failures					
• with low demand rate according to SN 31920	40 %				
• with high demand rate according to SN 31920	73 %				
B10 value with high demand rate according to SN 31920	1 000 000				
failure rate [FIT] with low demand rate according to SN 31920	100 FIT				
ISO 13849					
device type according to ISO 13849-1	3				
overdimensioning according to ISO 13849-2 necessary	Yes				
IEC 61508					
safety device type according to IEC 61508-2	Type A				
Electrical Safety					
protection class IP on the front according to IEC 60529	IP20				
touch protection on the front according to IEC 60529	finger-safe, for vertical contact from the front				
Approvals Certificates					
Environmental Product Declaration					
• global warming potential [CO2 eq] / during manufacturing	1.9 kg				
• global warming potential [CO2 eq] / during operation	72.4 kg				
• global warming potential [CO2 eq] / after end of life	-0.117 kg				
• global warming potential [CO2 eq] / total	74.2 kg				
Environment	General Product Approval				
Environmental Confirmations	    				
General Product Approval	EMV	Test Certificates			
    		Special Test Certificate			
Test Certificates	Maritime application				
Type Test Certificates/Test Report	    				
Maritime application	other				
	Confirmation	Miscellaneous	Confirmation	Confirmation	Miscellaneous
other	Railway				



Further information

Information on the packaging

<https://support.industry.siemens.com/cs/ww/en/view/109813875>

Information for data generation and storage

<https://support.industry.siemens.com/cs/ww/en/view/109995012>

Information- and Downloadcenter (Catalogs, Brochures,...)

<https://www.siemens.com/ic10>

Industry Mall (Online ordering system)

<https://mall.industry.siemens.com/mall/en/en/Catalog/product?mlfb=3RT2025-1AV00>

Service&Support (Manuals, Certificates, Characteristics, FAQs,...)

<https://support.industry.siemens.com/cs/ww/en/ps/3RT2025-1AV00>

Image database (product images, 2D dimension drawings, 3D models, device circuit diagrams, EPLAN macros, ...)

https://www.automation.siemens.com/bilddb/cax_de.aspx?mlfb=3RT2025-1AV00&lang=en

Cax online generator

<https://support.automation.siemens.com/WW/CAXorder/default.aspx?lang=en&mlfb=3RT2025-1AV00>

Characteristic curves

[https://curves.simaris.siemens.com/curves/<mmp_prod_noCOMP="HAUPT"></mmp_prod_no>](https://curves.simaris.siemens.com/curves/<mmp_prod_noCOMP=)

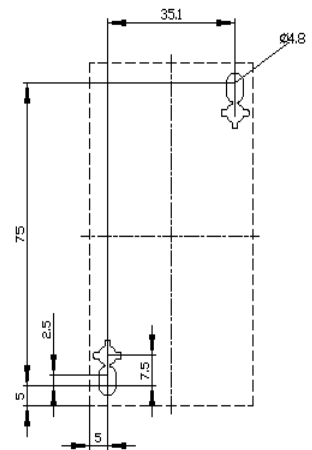
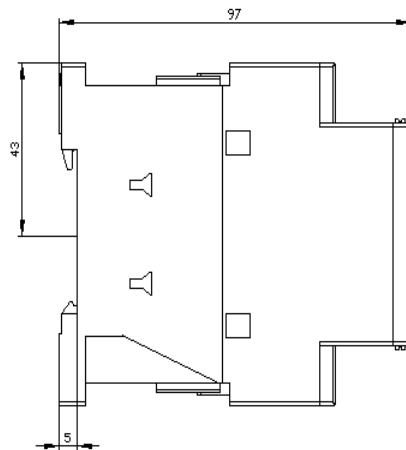
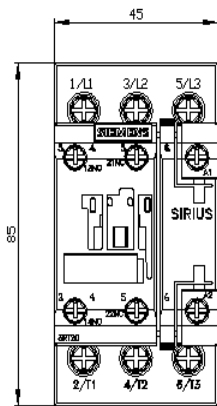

last modified:

4/4/2026 