



RC unit, 2-pole, type A, short-time delayed, In: 63 A, 30 mA, Un AC: 400 V

Model	
product brand name	SENTRON
product designation	RC unit electronic
design of the product	Short-time delayed
General technical data	
number of poles	2
degree of pollution	2
tripping fault current rated value	30 mA
Supply voltage	
value range of the supply voltage frequency	50 Hz
value range of the supply voltage at AC	400 V
Dissipation	
power loss [W]	0.8 W
<ul style="list-style-type: none"> for rated value of the current at AC in hot operating state per pole 	
Appearance	
RAL color number	7 035
RAL color number (similar)	7 035
Mechanical Design	
Net Weight	170 g
Approvals Certificates	
Environment	General Product Approval

[Environmental Con-
firmations](#)

[Environmental Con-
firmations](#)



[Confirmation](#)



General Product Ap-
proval

other



[Confirmation](#)

Further information

Information on the packaging

<https://support.industry.siemens.com/cs/ww/en/view/109813875>

Information for data generation and storage

<https://support.industry.siemens.com/cs/ww/en/view/109995012>

Information- and Downloadcenter (Catalogs, Brochures,...)

<https://www.siemens.com/lowvoltage/catalogs>

Industry Mall (Online ordering system)

<https://mall.industry.siemens.com/mall/en/en/Catalog/product?mlfb=5SM9325-6KK01>

Service&Support (Manuals, Certificates, Characteristics, FAQs,...)

<https://support.industry.siemens.com/cs/ww/en/ps/5SM9325-6KK01>

Image database (product images, 2D dimension drawings, 3D models, device circuit diagrams, ...)

https://www.automation.siemens.com/bilddb/cax_en.aspx?mlfb=5SM9325-6KK01

CAX-Online-Generator

<https://www.siemens.com/cax>

Tender specifications

<https://www.siemens.com/specifications>

Characteristic curves

[https://curves.simaris.siemens.com/curves/<mmp_prod_noCOMP="HAUPT"></mmp_prod_no>](https://curves.simaris.siemens.com/curves/<mmp_prod_noCOMP=)

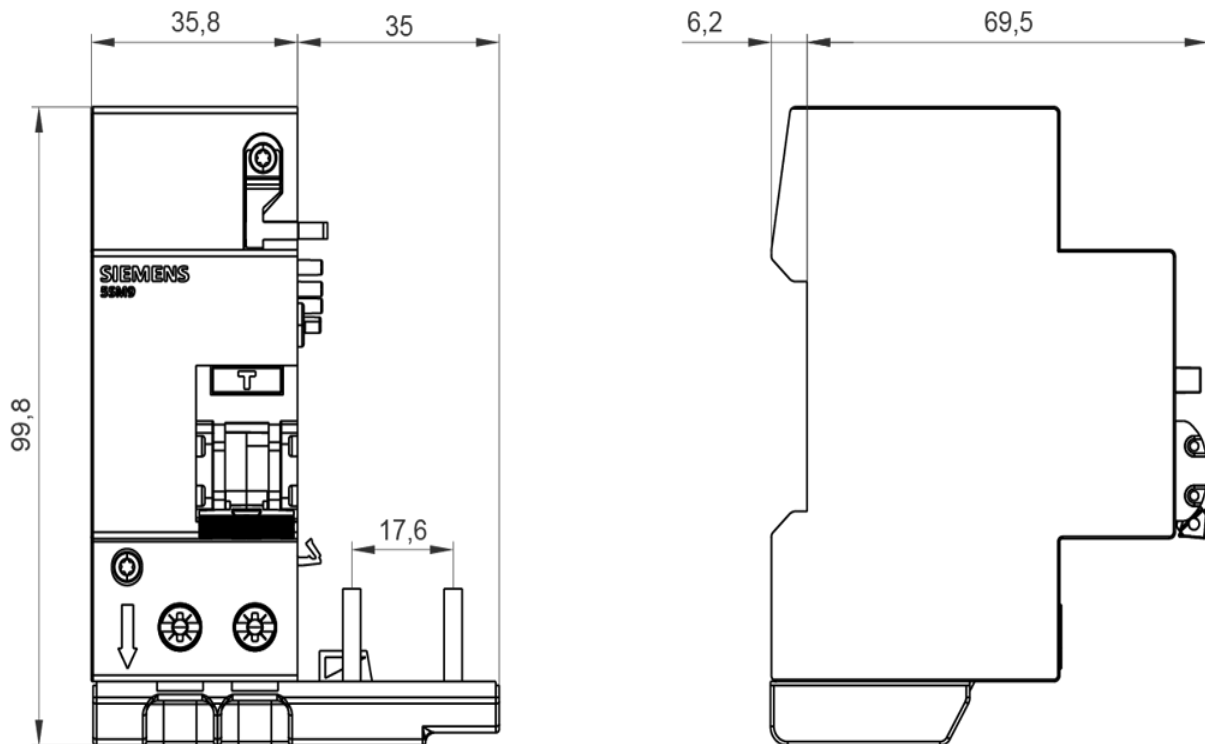

last modified:

10/9/2025

